

127-1430-70

BSP534 LED

we-ef



Description

IP55, Class I. Class II on request. IK10. Marine-grade, die-cast aluminium alloy. 5CE superior corrosion protection including PCS hardware. Silicone rubber gasket. Polycarbonate main lens. Integral EC electronic converter in thermally separated compartment. CAD-optimised optics for superior illumination and glare control. OLC® One LED Concept. Factory installed LED circuit board. The luminaire is factory-sealed and does not need to be opened during installation.

Optional 2200 K version available. To be specified at time of ordering.

Brackets to be ordered separately.

Weight	5.90 kg
Light distribution	asymmetric, side throw beam [S65]
Light source	LED-24/48W / 700 mA - 2700 K
CRI	70
Power supply	EC
LEDs	24
Rated input power	54 W

Nominal Lumen (lm)

LED Lumen	290
Total Lumen	6960
Tj	85

Rated lumens (lm)

LED Lumen	246.7
Total Lumen	5920.9
Ta	25

Fagerhult Lighting Ltd

33-34 Dolben Street, SE1 0UQ London, United Kingdom

<https://we-ef.com/uk>

Subject to technical changes and errors. - Generated on 23/11/2024

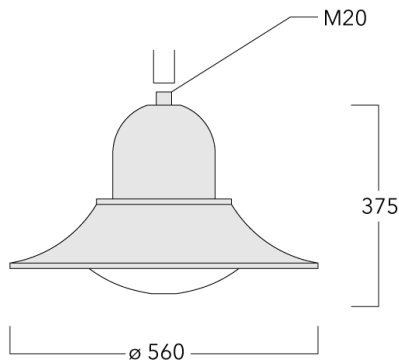

Specifications

Material description

Body	Marine-grade, die-cast aluminium alloy
Lens	Polycarbonate lens
Colours	<div style="display: flex; align-items: center;"> <div style="width: 20px; height: 20px; background-color: black; margin-right: 5px;"></div> RAL9004 Signal black </div> <div style="display: flex; align-items: center; margin-top: 5px;"> <div style="width: 20px; height: 20px; background-color: #cccccc; margin-right: 5px;"></div> RAL9006 White aluminium </div> <div style="display: flex; align-items: center; margin-top: 5px;"> <div style="width: 20px; height: 20px; background-color: #808080; margin-right: 5px;"></div> RAL9007 Grey aluminium </div> <div style="display: flex; align-items: center; margin-top: 5px;"> <div style="width: 20px; height: 20px; background-color: #333333; margin-right: 5px;"></div> RAL7016 Anthracite grey </div> <div style="display: flex; align-items: center; margin-top: 5px;"> <div style="width: 20px; height: 20px; background-color: #e0e0e0; margin-right: 5px;"></div> RAL9016 Traffic white </div>
Gasket	Silicone rubber gasket
Fasteners	PCS Polymer Coated Stainless Steel Hardware
Ingress protection	IP55
Impact resistance	IK10
Corrosion resistance	5CE
Windage	0.0930 m ²

Electrical description

Power supply	220-240V / 50-60 Hz
Driver / Ballast	Integral EC electronic converter. DALI
Power factor	> 0.9
Surge protection	6/6 kV (optional SP10)

127-1430-70

BSP534 LED

we-ef

Additional information

Lifetime Ta=25° L90B10 > 90000h

Energy efficiency class C-D (Light source)

Fagerhult Lighting Ltd

33-34 Dolben Street, SE1 0UQ London, United Kingdom

<https://we-ef.com/uk>

Subject to technical changes and errors. - Generated on 23/11/2024

127-1430-70

BSP534 LED

we-ef

Control

Eco Step Dim® Basic

Description	Part ID
Eco Step Dim® Basic LED	430-0001

Eco Step Dim® Advanced

Description	Part ID
Eco Step Dim® Advanced LED	430-0002

Fagerhult Lighting Ltd

33-34 Dolben Street, SE1 0UQ London, United Kingdom

<https://we-ef.com/uk>

Subject to technical changes and errors. - Generated on 23/11/2024

Mounting Accessories

Wall and pole brackets BA

Description	Part ID	C1	D x L1	H1	H2	M1	Weight (kg)	C	H
BA0-420 Wall bracket, single	300-0152	460		1000	132	9	2	460	1000

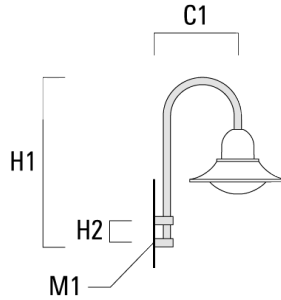

BA1-420 Pole bracket, single	300-0099	420	76 x 80	1000			4	420	1000
------------------------------	----------	-----	---------	------	--	--	---	-----	------

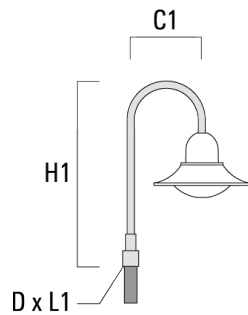

BSP534 LED

Description	Part ID	C1	D x L1	H1	H2	M1	Weight (kg)	C	H
BA2-420 Pole bracket, double	300-0104	500	76 x 80	1000			8	500	1000

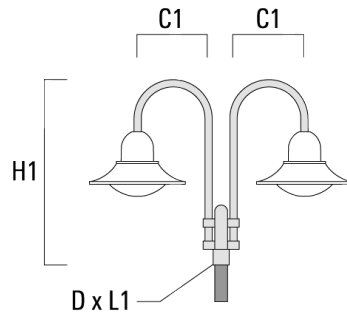

BA3-420 Pole bracket, triple	300-0109	500	76 x 80	1000			10	500	1000
------------------------------	----------	-----	---------	------	--	--	----	-----	------

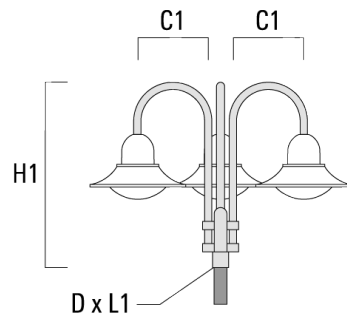

Wall and pole brackets BC

Description	Part ID	C1	H1	H2	M1	Weight (kg)	C	H
BC0-420 Wall bracket, single	300-0808	460	1230	300	8	2.30	460	1230

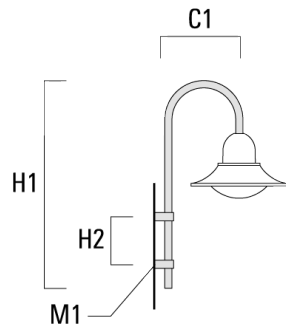

BC1-420 Pole bracket, single	300-0768	500	1230	300	8	2.30	500	1230
------------------------------	----------	-----	------	-----	---	------	-----	------

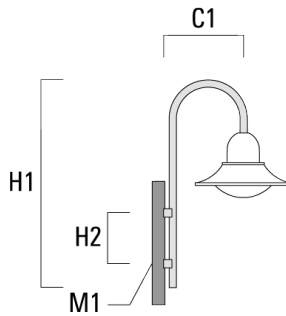

BSP534 LED

Description	Part ID	C1	H1	H2	M1	Weight (kg)	C	H
BC2-420 Pole bracket, double	300-0767	500	1230	300	8	4.60	500	1230

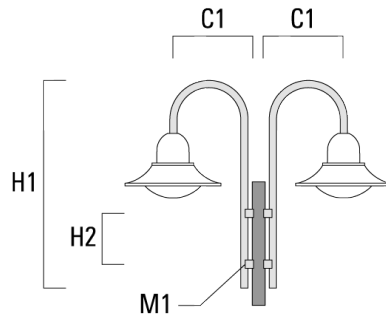

Wall and pole brackets DA

Description	Part ID	C1	C2	D × L1	H1	Weight (kg)	C	H
DA0-500 Wall bracket, single	300-0146	510	70		650	5.70	510	650

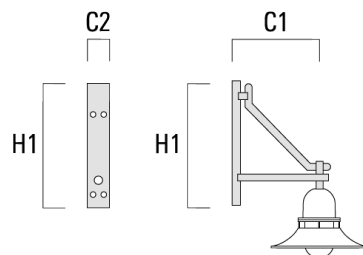

BSP534 LED

Description	Part ID	C1	C2	D x L1	H1	Weight (kg)	C	H
DA1-500 Pole bracket, single	300-0138	510		76 x 80	700	5.70	510	700

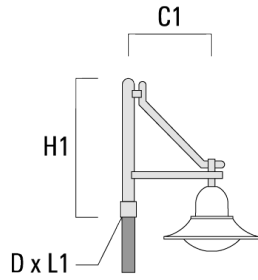

DA2-500 Pole bracket, double	300-0141	510		76 x 80	700	8.30	510	700
------------------------------	----------	-----	--	---------	-----	------	-----	-----

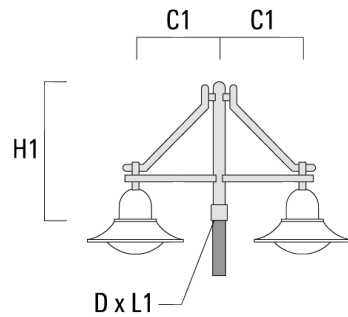

BSP534 LED

Description	Part ID	C1	C2	D × L1	H1	Weight (kg)	C	H
DA3-500 Pole bracket, triple	300-0144	510		76 x 80	700	10.90	510	700

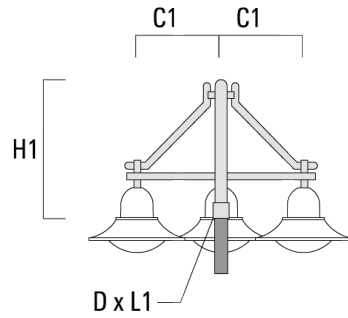

Wall and pole brackets DB

Description	Part ID	C1	C2	D × L1	H1	Weight (kg)	C	H
DB0-500 Wall bracket, single	300-0169	510	70		650	5.50	510	650

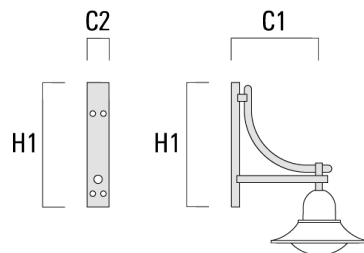

BSP534 LED

Description	Part ID	C1	C2	D × L1	H1	Weight (kg)	C	H
DB1-500 Pole bracket, single	300-0190	510		76 x 80	700	5.50	510	700

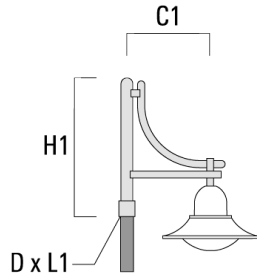

DB2-500 Pole bracket, double	300-0191	510		76 x 80	700	7.90	510	700
------------------------------	----------	-----	--	---------	-----	------	-----	-----

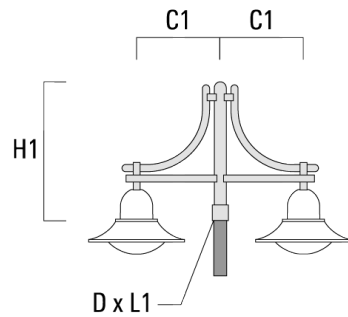

BSP534 LED

Description	Part ID	C1	C2	D × L1	H1	Weight (kg)	C	H
DB3-500 Pole bracket, triple	300-0192	510		76 x 80	700	10.30	510	700

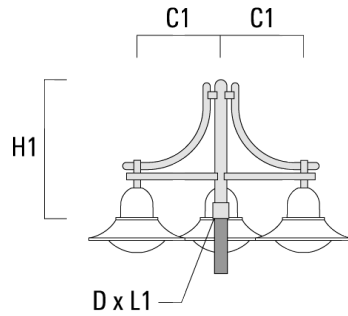

Wall and pole brackets DS

Description	Part ID	C1	C2	D × L1	H1	Weight (kg)	C	H
DS0-500 Wall bracket, single	300-0064	510	70		650	2.50	510	650

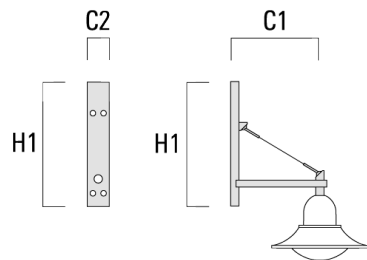

BSP534 LED

Description	Part ID	C1	C2	D x L1	H1	Weight (kg)	C	H
DS1-500 Pole bracket, single	300-0063	510		76 x 80	725	3.90	510	725

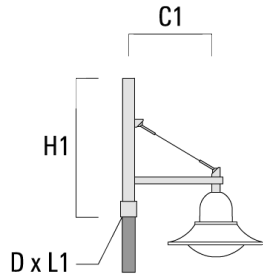

DS2-500 Pole bracket, double	300-0066	510		76 x 80	725	5.30	510	725
------------------------------	----------	-----	--	---------	-----	------	-----	-----

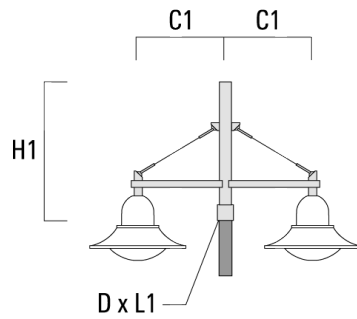

127-1430-70

we-ef

BSP534 LED

Description	Part ID	C1	C2	D x L1	H1	Weight (kg)	C	H
DS3-500 Pole bracket, triple	300-0069	510		76 x 80	725	6.70	510	725

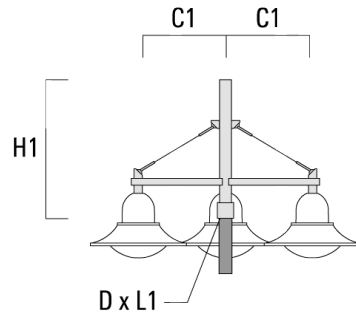

127-1430-70

BSP534 LED

we-ef

Optical Accessories

Light shield

Description	Part ID	Additional information
LS180	430-0029	Glare Shield for backlight spill. Glare Shield factory-installed or available as retrofit kit. Suitable for [S60], [S65], [S70], [R65], [P65] lenses. Must be specified at time of ordering.