

105-9944-70

RMT320 LED Two-sided

**we-ef**

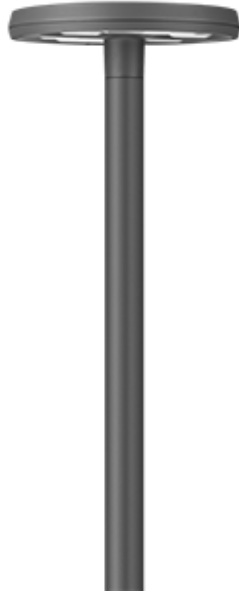

**Description**

IP66. Post top LED luminaire. Integrated heat sinks. Easy removal and replacement of LED board. CAD-optimized OLC PMMA lens for multi-layer illumination and superior glare control.

Weight	8.00 lb
Light distribution	[S70] Type II Short
Light source	LED-24/72W / 1050 mA - 3000 K
CRI	70
Power supply	electronic gear
LEDs	24
Rated input power	79 W
<b>Nominal Lumen (lm)</b>	
LED Lumen	490
Total Lumen	11760
Tj	85
<b>Rated lumens (lm)</b>	
LED Lumen	450.9
Total Lumen	10820.6
Ta	25

**WE-EF LIGHTING USA, LLC**

410-D Keystone Drive, 15086 Warrendale, PA 15086 - Phone: +1 724 742 0030  
customersupport.usa@we-ef.com - <https://we-ef.com/us>  
Subject to technical changes and errors. - Generated on 11/23/2024

105-9944-70



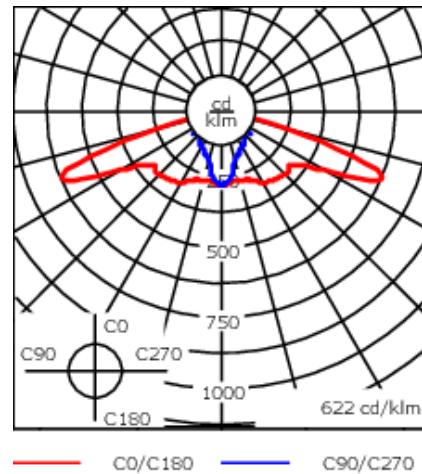
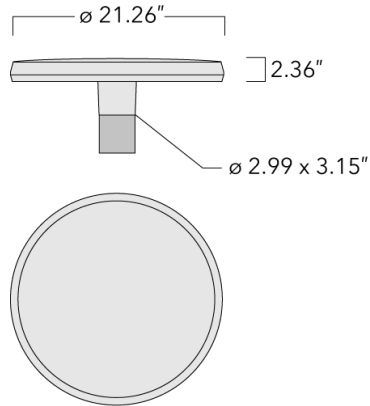

**we-ef**

**RMT320 LED Two-sided**



## Specifications

### Material description

Body	Marine-grade, die-cast aluminium alloy
Lens	RFC® Reflection Free Contour technology
Colors	 RAL9004 Black  RAL9007 Grey Metallic  RAL9016 White  RAL8019 Dark Bronze
Gasket	Silicone CCG® Controlled Compression Gasket
Fasteners	PCS Polymer Coated Stainless Steel Hardware
Ingress protection	IP66
Impact resistance	IK09
Corrosion resistance	5CE

### Electrical description

Power supply	220-240V / 50-60 Hz
Driver / Ballast	Integral EC electronic converter
Power factor	> 0.9

#### WE-EF LIGHTING USA, LLC

410-D Keystone Drive, 15086 Warrendale, PA 15086 - Phone: +1 724 742 0030

customersupport.usa@we-ef.com - <https://we-ef.com/us>

Subject to technical changes and errors. - Generated on 11/23/2024

**105-9944-70**

**we-ef**

**RMT320 LED Two-sided**

**Additional information**

---

Lifetime

Ta=25°/40° L90B10 > 90000h

---

**WE-EF LIGHTING USA, LLC**

410-D Keystone Drive, 15086 Warrendale, PA 15086 - Phone: +1 724 742 0030  
customersupport.usa@we-ef.com - <https://we-ef.com/us>

Subject to technical changes and errors. - Generated on 11/23/2024