

127-1436-70

BSP544 LED

we-ef



Description

IP55, Class I. Cass II on request. IK10. Marine-grade, die-cast aluminium alloy. 5CE superior corrosion protection including PCS hardware. Silicone rubber gasket. Polycarbonate main lens. Integral EC electronic converter in thermally separated compartment. CAD-optimised optics for superior illumination and glare control. OLC® One LED Concept. Factory installed LED circuit board. The luminaire is factory-sealed and does not need to be opened during installation.

Optional 2200 K version available. To be specified at time of ordering.

Brackets to be ordered separately.

Weight	13.10 kg
Light distribution	rectangular, side throw [R65]
Light source	LED-36/72W / 700 mA - 2700 K
CRI	70
Power supply	EC
LEDs	36
Rated input power	79 W

Nominal Lumen (lm)

LED Lumen	290
Total Lumen	10440
Tj	85

Rated lumens (lm)

LED Lumen	225
Total Lumen	8098.3
Ta	25

Fagerhult Lighting Ltd

33-34 Dolben Street, SE1 0UQ London, United Kingdom

<https://we-ef.com/uk>

Subject to technical changes and errors. - Generated on 23/11/2024

127-1436-70



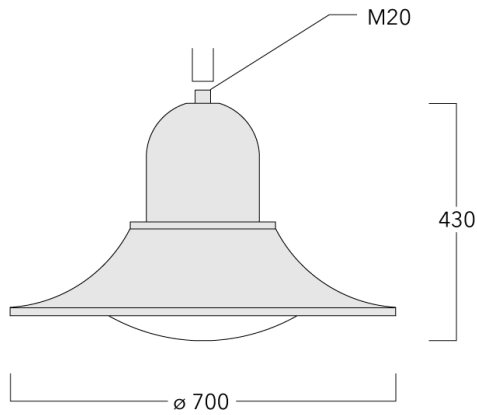

BSP544 LED

we-ef



Specifications

Material description

Body	Marine-grade, die-cast aluminium alloy
Lens	Polycarbonate
Colours	 RAL9004 Signal black  RAL9006 White aluminium  RAL9007 Grey aluminium  RAL7016 Anthracite grey  RAL9016 Traffic white
Gasket	Silicone rubber gasket
Fasteners	PCS Polymer Coated Stainless Steel Hardware
Ingress protection	IP55
Impact resistance	IK10
Corrosion resistance	5CE
Windage	0.1246 m ²

Electrical description

Power supply	220-240V / 50-60 Hz
Driver / Ballast	Integral EC electronic converter. DALI
Power factor	> 0.9
Surge protection	6/6 kV (optional SP10)

Fagerhult Lighting Ltd

33-34 Dolben Street, SE1 0UQ London, United Kingdom

<https://we-ef.com/uk>

Subject to technical changes and errors. - Generated on 23/11/2024

127-1436-70

BSP544 LED

we-ef

Additional information

Lifetime Ta=25° L90B10 > 90000h

Energy efficiency class C-D (Light source)

Fagerhult Lighting Ltd

33-34 Dolben Street, SE1 0UQ London, United Kingdom

<https://we-ef.com/uk>

Subject to technical changes and errors. - Generated on 23/11/2024

127-1436-70

BSP544 LED

we-ef

Control

Eco Step Dim® Basic

Description	Part ID
Eco Step Dim® Basic LED	430-0001

Eco Step Dim® Advanced

Description	Part ID
Eco Step Dim® Advanced LED	430-0002

Fagerhult Lighting Ltd

33-34 Dolben Street, SE1 0UQ London, United Kingdom

<https://we-ef.com/uk>

Subject to technical changes and errors. - Generated on 23/11/2024

Mounting Accessories

Wall and pole brackets BA

Description	Part ID	C1	D x L1	H1	H2	M1	Weight (kg)	C	H
BA0-580 Wall bracket, single	300-0149	635		1000	132	9	2.50	635	1000



BA1-580 Pole bracket, single	300-0089	580	76 x 80	1000			4.50	580	1000
------------------------------	----------	-----	---------	------	--	--	------	-----	------



BSP544 LED

Description	Part ID	C1	D x L1	H1	H2	M1	Weight (kg)	C	H
BA2-580 Pole bracket, double	300-0090	675	76 x 80	1000			8.50	675	1000



BA3-580 Pole bracket, triple	300-0093	675	76 x 80	1000			10.50	675	1000
------------------------------	----------	-----	---------	------	--	--	-------	-----	------



Wall and pole brackets BC

Description	Part ID	C1	H1	H2	M1	Weight (kg)	C	H
BC0-580 Wall bracket, double	300-0771	635	1325	300	8	2.80	635	1325



BC1-580 Pole bracket, single	300-0770	675	1325	300	8	2.80	675	1325
------------------------------	----------	-----	------	-----	---	------	-----	------



BSP544 LED

Description	Part ID	C1	H1	H2	M1	Weight (kg)	C	H
BC2-580 Pole bracket, double	300-0769	675	1325	300	8	5.60	675	1325



Wall and pole brackets DA

Description	Part ID	C1	C2	D × L1	H1	Weight (kg)	C	H
DA0-750 Wall bracket, single	300-0086	720	70		950	7.30	720	950

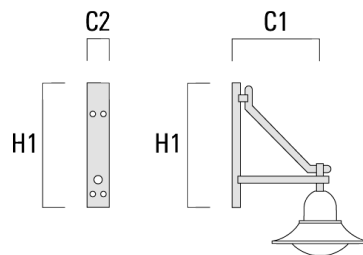

BSP544 LED

Description	Part ID	C1	C2	D x L1	H1	Weight (kg)	C	H
DA1-750 Pole bracket, single	300-0083	720		76 x 130	950	7.30	720	950



DA2-750 Pole bracket, double	300-0084	720		76 x 130	950	10.60	720	950
------------------------------	----------	-----	--	----------	-----	-------	-----	-----



BSP544 LED

Description	Part ID	C1	C2	D × L1	H1	Weight (kg)	C	H
DA3-750 Pole bracket, triple	300-0085	720		76 x 130	950	13.90	720	950



Wall and pole brackets DB

Description	Part ID	C1	C2	D × L1	H1	Weight (kg)	C	H
DB0-750 Wall bracket, single	300-0172	720	70		950	7.10	720	950



BSP544 LED

Description	Part ID	C1	C2	D x L1	H1	Weight (kg)	C	H
DB1-750 Pole bracket, single	300-0165	720		76 x 130	950	7.10	720	950

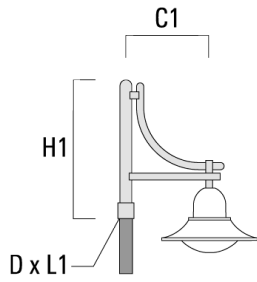

DB2-750 Pole bracket, double	300-0168	720		76 x 130	950	10.20	720	950
------------------------------	----------	-----	--	----------	-----	-------	-----	-----



BSP544 LED

Description	Part ID	C1	C2	D × L1	H1	Weight (kg)	C	H
DB3-750 Pole bracket, triple	300-0170	720		76 x 130	950	13.30	720	950



Wall and pole brackets DS

Description	Part ID	C1	C2	D × L1	H1	Weight (kg)	C	H
DS0-750 Wall bracket, single	300-0070	750	70		700	2.60	750	700



BSP544 LED

Description	Part ID	C1	C2	D x L1	H1	Weight (kg)	C	H
DS1-750 Pole bracket, single	300-0477	750		76 x 130	850	5.50	750	850

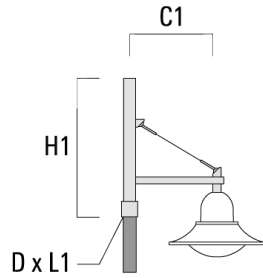

DS2-750 Pole bracket, double	300-0765	750		76 x 130	850	7.20	750	850
------------------------------	----------	-----	--	----------	-----	------	-----	-----



BSP544 LED

Description	Part ID	C1	C2	D x L1	H1	Weight (kg)	C	H
DS3-750 Pole bracket, triple	300-0766	750		76 x 130	850	8.90	750	850



127-1436-70

BSP544 LED

we-ef

Optical Accessories

Light shield

Description	Part ID	Additional information
LS180	430-0029	Glare Shield for backlight spill. Glare Shield factory-installed or available as retrofit kit. Suitable for [S60], [S65], [S70], [R65], [P65] lenses. Must be specified at time of ordering.