



### Description

IP55. Classe I. Classe II sur demande. IK10. Corps en fonte d'aluminium. Visserie inox avec traitement PCS. Protection contre la corrosion 5CE. Joint silicone. Modules LED interchangeables avec dissipateur de chaleur. Lentille PMMA avec technologie OLC® pour la maîtrise du flux et la précision de l'éclairage.

Version en 2200K disponible. À préciser lors de la demande de devis.

Poids	13.10 kg
Distribution de la lumière	[S65] Eclairage routier - basses luminances
Source lumineuse	LED-36/72W / 700 mA - 4000 K
IRC	70
Alimentation électrique	ballast électronique
LEDs	36
Rated input power	79 W

### Flux lumineux nominal (lm)

LED Lumen	350
Total Lumen	12600
Tj	85

### Rated lumens (lm)

LED Lumen	297.7
Total Lumen	10718.9
Ta	25

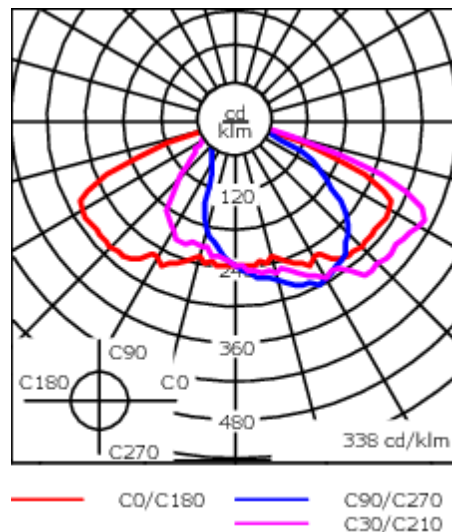
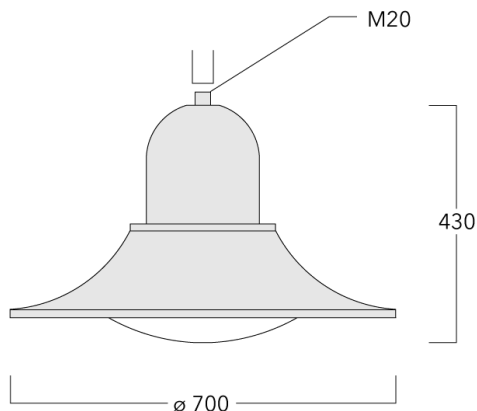

## Spécifications

### Description du matériel

Corps	Corps en fonte d'aluminium
Lentille	Polycarbonate lens
Couleurs	<div style="display: flex; align-items: center;"> <div style="width: 20px; height: 10px; background-color: black; margin-right: 5px;"></div> <span>RAL9004 Noir de sécurité</span> </div> <div style="display: flex; align-items: center; margin-top: 5px;"> <div style="width: 20px; height: 10px; background-color: gray; margin-right: 5px;"></div> <span>RAL9007 Aluminium gris</span> </div> <div style="display: flex; align-items: center; margin-top: 5px;"> <div style="width: 20px; height: 10px; background-color: darkgray; margin-right: 5px;"></div> <span>RAL7016 Gris anthracite</span> </div> <div style="display: flex; align-items: center; margin-top: 5px;"> <div style="width: 20px; height: 10px; background-color: lightgray; margin-right: 5px;"></div> <span>RAL9016 Blanc signalisation</span> </div>
Joint	Joint silicone
Visserie	PCS Inox avec revêtement polymère
IP	IP55
IK	IK10
Protection contre la corrosion	5CE
Surface exposée au vent	0.1246 m <sup>2</sup>

### Description électrique

Alimentation électrique	220-240V / 50-60 Hz
Driver	Driver électronique. DALI
Power factor	> 0.9

#### WE-EF Switzerland AG

Himmelrichstrasse 6, 6003 Luzern - Téléphone: +41 22 752 49 94

info.switzerland@we-ef.com - [https://we-ef.com/ch\\_fr](https://we-ef.com/ch_fr)

Sous réserve de modifications techniques et d'erreurs. - Généré le 23/10/2024

**127-1305-70**

**BSP544 LED**

**we-ef**

### **Informations complémentaires**

---

Durée de vie Ta=25° L90B10 > 90000h

Classe d'efficacité  
énergétique C-D

---

**WE-EF Switzerland AG**

Himmelrichstrasse 6, 6003 Luzern - Téléphone: +41 22 752 49 94

info.switzerland@we-ef.com - [https://we-ef.com/ch\\_fr](https://we-ef.com/ch_fr)

Sous réserve de modifications techniques et d'erreurs. - Généré le 23/10/2024

## Control

### Eco Step Dim® Basic

Description	Référence
Eco Step Dim® Basic LED	430-0001

### Eco Step Dim® Advanced

Description	Référence
Eco Step Dim® Advanced LED	430-0002

## Accessoires d'installation

## Crosses murales et Crosses pour mât BA

Description	Référence	C1	D x L1	H1	H2	M1	Poids (kg)	C	H
BA0-580 crosse murale	300-0149	635		1000	132	9	2.50	635	1000

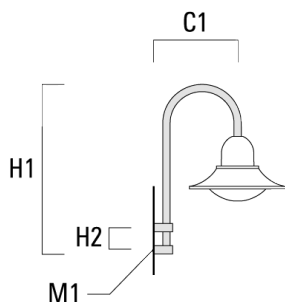

BA1-580 crosse simple	300-0089	580	76 x 80	1000			4.50	580	1000
-----------------------	----------	-----	---------	------	--	--	------	-----	------

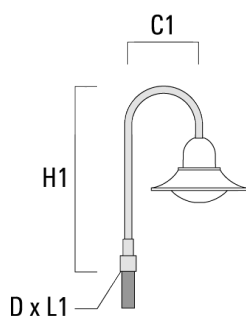

## BSP544 LED

Description	Référence	C1	D x L1	H1	H2	M1	Poids (kg)	C	H
BA2-580 crosse double	300-0090	675	76 x 80	1000			8.50	675	1000

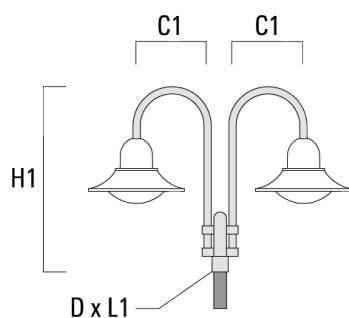

BA3-580 crosse triple	300-0093	675	76 x 80	1000			10.50	675	1000
-----------------------	----------	-----	---------	------	--	--	-------	-----	------

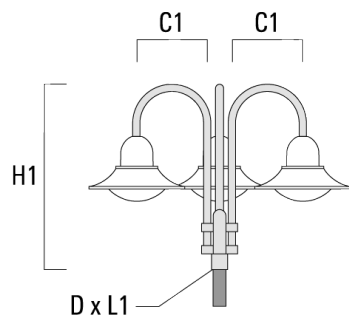

## Crosses murales et Crosses pour mât BC

## WE-EF Switzerland AG

Himmelrichstrasse 6, 6003 Luzern - Téléphone: +41 22 752 49 94

info.switzerland@we-ef.com - [https://we-ef.com/ch\\_fr](https://we-ef.com/ch_fr)

Sous réserve de modifications techniques et d'erreurs. - Généré le 23/10/2024

## BSP544 LED

Description	Référence	C1	H1	H2	M1	Poids (kg)	C	H
BC0-580 crosse murale	300-0771	635	1325	300	8	2.80	635	1325

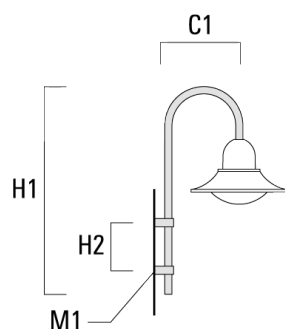

BC1-580 crosse simple	300-0770	675	1325	300	8	2.80	675	1325
-----------------------	----------	-----	------	-----	---	------	-----	------

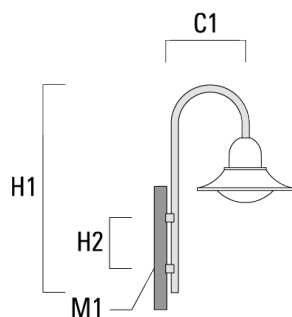

## BSP544 LED

Description	Référence	C1	H1	H2	M1	Poids (kg)	C	H
BC2-580 crosse double	300-0769	675	1325	300	8	5.60	675	1325

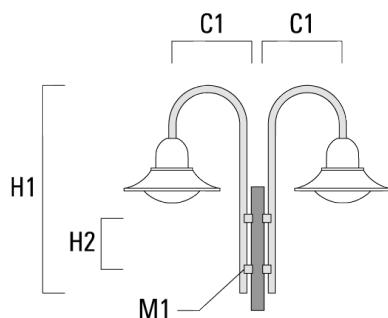

## Crosses murales et Crosses pour mât DA

Description	Référence	C1	C2	D × L1	H1	Poids (kg)	C	H
DA0-750 crosse murale	300-0086	720	70		950	7.30	720	950

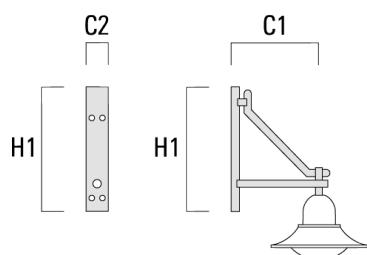

## WE-EF Switzerland AG

Himmelrichstrasse 6, 6003 Luzern - Téléphone: +41 22 752 49 94

info.switzerland@we-ef.com - [https://we-ef.com/ch\\_fr](https://we-ef.com/ch_fr)

Sous réserve de modifications techniques et d'erreurs. - Généré le 23/10/2024



## BSP544 LED

Description	Référence	C1	C2	D x L1	H1	Poids (kg)	C	H
DA1-750 crosse simple	300-0083	720		76 x 130	950	7.30	720	950

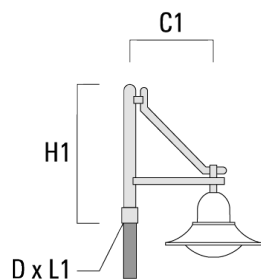

DA2-750 crosse double	300-0084	720		76 x 130	950	10.60	720	950
-----------------------	----------	-----	--	----------	-----	-------	-----	-----

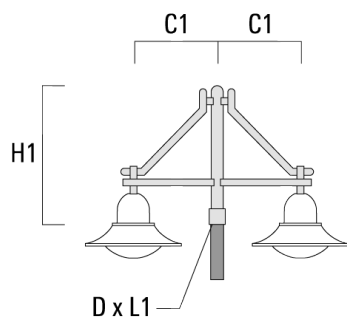

## BSP544 LED

Description	Référence	C1	C2	D x L1	H1	Poids (kg)	C	H
DA3-750crosse triple	300-0085	720		76 x 130	950	13.90	720	950

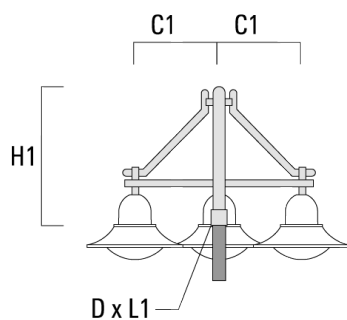

## Crosses murales et Crosses pour mât DB

Description	Référence	C1	C2	D x L1	H1	Poids (kg)	C	H
DB0-750 crosse murale	300-0172	720	70		950	7.10	720	950

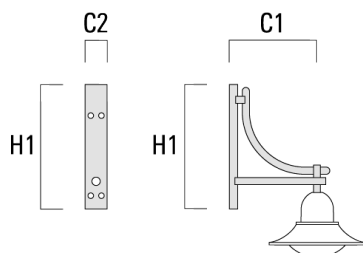

## WE-EF Switzerland AG

Himmelrichstrasse 6, 6003 Luzern - Téléphone: +41 22 752 49 94

info.switzerland@we-ef.com - [https://we-ef.com/ch\\_fr](https://we-ef.com/ch_fr)

Sous réserve de modifications techniques et d'erreurs. - Généré le 23/10/2024

## BSP544 LED

Description	Référence	C1	C2	D x L1	H1	Poids (kg)	C	H
DB1-750 crosse simple	300-0165	720		76 x 130	950	7.10	720	950

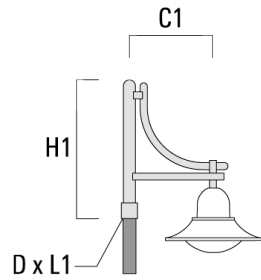

DB2-750 crosse double	300-0168	720		76 x 130	950	10.20	720	950
-----------------------	----------	-----	--	----------	-----	-------	-----	-----

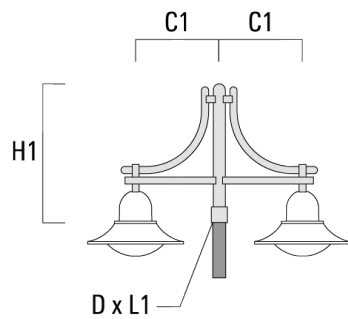

## BSP544 LED

Description	Référence	C1	C2	D x L1	H1	Poids (kg)	C	H
DB3-750 crosse triple	300-0170	720		76 x 130	950	13.30	720	950

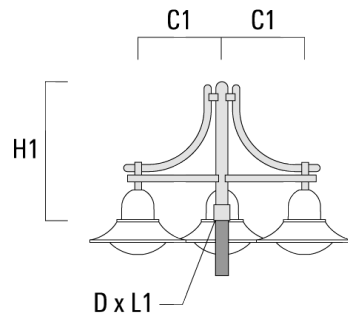

## Crosses murales et Crosses pour mât DS

Description	Référence	C1	C2	D x L1	H1	Poids (kg)	C	H
DS0-750 crosse murale	300-0070	750	70		700	2.60	750	700

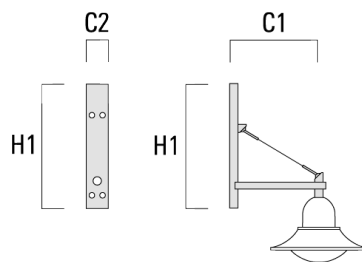

## WE-EF Switzerland AG

Himmelrichstrasse 6, 6003 Luzern - Téléphone: +41 22 752 49 94

info.switzerland@we-ef.com - [https://we-ef.com/ch\\_fr](https://we-ef.com/ch_fr)

Sous réserve de modifications techniques et d'erreurs. - Généré le 23/10/2024

## BSP544 LED

Description	Référence	C1	C2	D x L1	H1	Poids (kg)	C	H
DS1-750 crosse simple	300-0477	750		76 x 130	850	5.50	750	850



DS2-750 crosse double	300-0765	750		76 x 130	850	7.20	750	850
-----------------------	----------	-----	--	----------	-----	------	-----	-----



## BSP544 LED

Description	Référence	C1	C2	D x L1	H1	Poids (kg)	C	H
DS3-750 crosse triple	300-0766	750		76 x 130	850	8.90	750	850

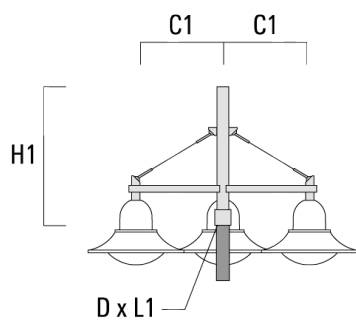

## Accessoires Optiques

### Light shield

Description	Référence	Informations complémentaires
LS180	430-0029	Coupe-flux arrière adapté pour les optiques [S60], [S65], [S70], [R65], [P65]. Coupe-flux arrière assemblé sur le luminaire en usine ou disponible pour le rétrofit. Cela doit être déterminé à la commande.

**127-1305-70**

**BSP544 LED**

**WE-EF Switzerland AG**

Himmelrichstrasse 6, 6003 Luzern

Téléphone: +41 22 752 49 94

[info.switzerland@we-ef.com](mailto:info.switzerland@we-ef.com)

[https://we-ef.com/ch\\_fr](https://we-ef.com/ch_fr)

Sous réserve de modifications techniques et d'erreurs.

Généré le 23/10/2024