

115-1518

LTM440 LED-FT

we-ef



Description

IP66, Class I. Class II on request. IK10. Marine-grade die-cast aluminium alloy. 5CE superior corrosion protection including PCS hardware. Silicone CCG® Controlled Compression Gasket. Polycarbonate main lens. CAD-optimised optics for superior illumination and glare control.

Service door with fused cable connecting box.

Weight	25.00 kg
Light distribution	symmetric distribution [C60]
Light source	LED-FT-17W / 500 mA - 4000 K
CRI	80
Power supply	EC
LEDs	1
Rated input power	20 W

Rated lumens (lm)

LED Lumen	2158.9
Total Lumen	2158.9
Ta	25

Nominal Lumen (lm)

LED Lumen	3200
Total Lumen	3200
Tc	25

Fagerhult Lighting Ltd

33-34 Dolben Street, SE1 0UQ London, United Kingdom

<https://we-ef.com/uk>

Subject to technical changes and errors. - Generated on 23/11/2024

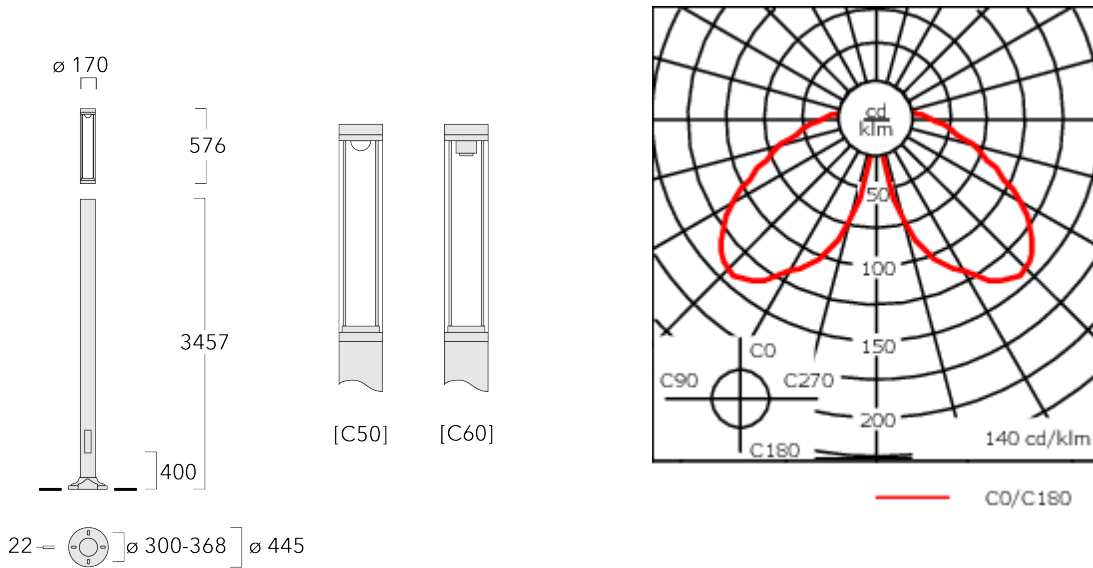

Specifications

Material description

Body	Marine-grade, all-aluminium construction
Lens	Polycarbonate lens
Colours	<ul style="list-style-type: none"> RAL9004 Signal black RAL9006 White aluminium RAL9007 Grey aluminium RAL7016 Anthracite grey RAL9016 Traffic white
Gasket	Silicone CCG® Controlled Compression Gasket
Fasteners	PCS Polymer Coated Stainless Steel hardware
Ingress protection	IP66
Impact resistance	IK10
Corrosion resistance	5CE

Electrical description

Power supply	220-240V / 50-60 Hz
Driver / Ballast	Integral EC electronic converter
Surge protection	10/10kV

Additional information

Lifetime	Ta=25° L70B50 > 50000h
Energy efficiency class	B-C (Light source)

Mounting Accessories

Planted root

Description	Part ID	D1	D2	D3	D4	H1	H2	M1	Weight (kg)
Planted root ESV10	300-0949	415	340	126	133	1000	500	18	25.30

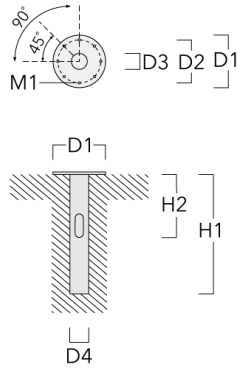

115-1518

LTM440 LED-FT

we-ef

Optical Accessories

Light shield

Description	Part ID
LS180-[C60]	159-0321

Fagerhult Lighting Ltd

33-34 Dolben Street, SE1 0UQ London, United Kingdom

<https://we-ef.com/uk>

Subject to technical changes and errors. - Generated on 23/11/2024