



### Description

Profile Projector [GP] for projection of gobos on a surface. Spherical and aspherical, double flat convex lens system. Gobo motif on request, to be ordered separately.

IP66, Class III. IK07. Marine-grade, die-cast aluminium alloy. 5CE superior corrosion protection including PCS hardware. Silicone CCG® Controlled Compression Gasket. Safety glass lens. Electronic control gear in separate gear box (constant current), prewired. Gearbox to be ordered separately. One factory installed flange plug M8 x 1.5. Cable length 10 ft. CAD-optimised optics for superior illumination and glare control. Factory-installed LED circuit board.

Gobo outside diameter 37.5 mm, max. printable area  $d = 28$  mm.

Weight	0.85 kg
Light distribution	symmetric Gobo-Projector [GP] - min aperture angle
Light source	LED-1/6W / 500 mA - 4000 K
CRI	80
Power supply	EC
LEDs	1
Rated input power	7.5 W

### Rated lumens (lm)

LED Lumen	308.3
Total Lumen	308.3
Ta	25

### Nominal Lumen (lm)

LED Lumen	720
Total Lumen	720
Tc	25

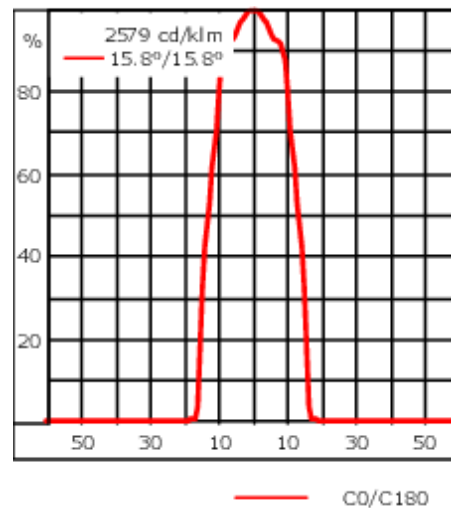

## Specifications

### Material description

Body	Marine-grade, die-cast aluminium alloy
Lens	Safety glass lens
Colours	<ul style="list-style-type: none"> <li><span style="display: inline-block; width: 15px; height: 15px; background-color: black; margin-right: 5px;"></span> RAL9004 Signal black</li> <li><span style="display: inline-block; width: 15px; height: 15px; background-color: #cccccc; margin-right: 5px;"></span> RAL9006 White aluminium</li> <li><span style="display: inline-block; width: 15px; height: 15px; background-color: #808080; margin-right: 5px;"></span> RAL9007 Grey aluminium</li> <li><span style="display: inline-block; width: 15px; height: 15px; background-color: #333333; margin-right: 5px;"></span> RAL7016 Anthracite grey</li> <li><span style="display: inline-block; width: 15px; height: 15px; background-color: #e0e0e0; margin-right: 5px;"></span> RAL9016 Traffic white</li> </ul>
Gasket	Silicone CCG® Controlled Compression Gasket
Fasteners	PCS Polymer Coated Stainless Steel Hardware
Ingress protection	IP66
Impact resistance	IK07
Corrosion resistance	5CE
Windage	0.11 ft <sup>2</sup>

### Electrical description

Power supply	220-240V / 50-60 Hz
Driver / Ballast	DALI
Power factor	> 0.9

**139-2751\_min**

**FLC201 LED [GP]**

**we-ef**

**Additional information**

---

Lifetime Ta=25° L90B10 > 90000h

Energy efficiency class D-E (Light source)

---

**Electrical Accessories**

**Gear box**

Description	Part ID	A	B	C1	C2	Weight (kg)
GB200 R130x80 gear box (small) DALI	139-2555	50	80	159	130	0.30



GB200 R200x120 gear box (medium) DALI	139-2622	75	120	229	200	
--	----------	----	-----	-----	-----	--



Description	Part ID	A	B	C1	C2	Weight (kg)
GB200 R230x140 gear box (large) SP10 DALI	139-2621	95	140	259	230	



## Mounting Accessories

### Junction box

Description	Part ID	A	B	C1	C2
JB200 R82 Junction box	139-2590	55	82	140	80

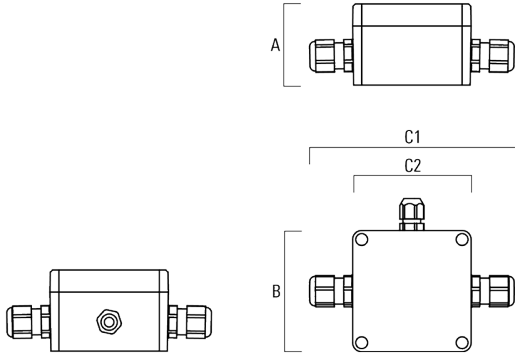

**139-2751\_min**

**FLC201 LED [GP]**

**we-ef**

## **Optical Accessories**

### **Gobo cartridge**

Description	Part ID
Gobo cartridge for FLC201 [GP]	139-2859

**Fagerhult Lighting Ltd**

33-34 Dolben Street, SE1 0UQ London, United Kingdom

<https://we-ef.com/uk>

Subject to technical changes and errors. - Generated on 23/11/2024