



### Description

Profile Projector [FP] for framing applications, polygon shape. Spherical and aspherical, double flat convex lens system.

IP66, Class III. IK07. Marine-grade, die-cast aluminium alloy. 5CE superior corrosion protection including PCS hardware. Silicone CCG® Controlled Compression Gasket. Safety glass lens. Electronic control gear in separate gear box (constant current), prewired. Gearbox to be ordered separately. One factory installed flange plug M8 x 1.5. Cable length 10 ft. CAD-optimised optics for superior illumination and glare control. Factory-installed LED circuit board.

Weight	0.85 kg
Light distribution	symmetric Framing-Projector [FP] - max aperture angle
Light source	LED-1/6W / 500 mA - 4000 K
CRI	80
Power supply	EC
LEDs	1
Rated input power	7.5 W
<b>Rated lumens (lm)</b>	
LED Lumen	401.1
Total Lumen	401.1
Ta	25
<b>Nominal Lumen (lm)</b>	
LED Lumen	720
Total Lumen	720
Tc	25

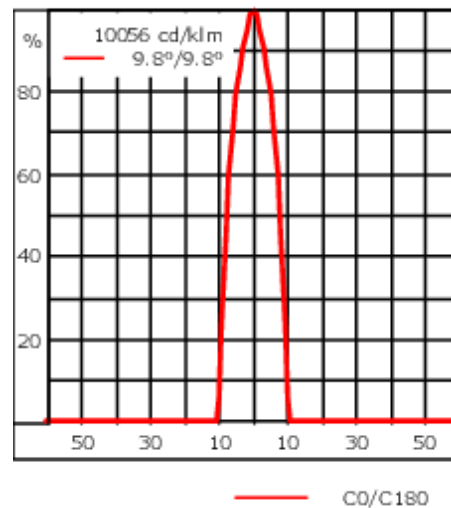

## Specifications

### Material description

Body	Marine-grade, die-cast aluminium alloy
Lens	Safety glass lens
Colours	<div style="display: flex; align-items: center;"> <div style="width: 20px; height: 15px; background-color: black; margin-right: 5px;"></div> <span>RAL9004 Signal black</span> </div> <div style="display: flex; align-items: center; margin-top: 5px;"> <div style="width: 20px; height: 15px; background-color: #cccccc; margin-right: 5px;"></div> <span>RAL9006 White aluminium</span> </div> <div style="display: flex; align-items: center; margin-top: 5px;"> <div style="width: 20px; height: 15px; background-color: #808080; margin-right: 5px;"></div> <span>RAL9007 Grey aluminium</span> </div>
Gasket	Silicone CCG® Controlled Compression Gasket
Fasteners	Eingebauter Flanschstecker M8 x 1,5. Anschlussleitung 3 m
Ingress protection	IP66
Impact resistance	IK07
Corrosion resistance	5CE
Windage	0.11 ft <sup>2</sup>

### Electrical description

Driver / Ballast	DALI
Power factor	> 0.9

### Additional information

Lifetime	Ta=40° L90B10 > 90000h
----------	------------------------

#### WE-EF LIGHTING Pty Ltd

6/13 Downard Street, 3195 Braeside, Victoria - Phone: +61 3 8587 0444 - Fax: +61 3 8587 0499

info.australia@we-ef.com - <https://we-ef.com/aus>

Subject to technical changes and errors. - Generated on 23/10/2024

**Electrical Accessories**

**Gear box**

Description	Part ID	A	B	C1	C2	Weight (kg)
GB200 R130x80 gear box (small) DALI	139-2555	50	80	159	130	0.30

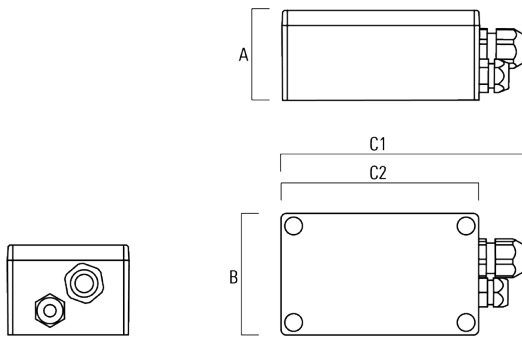

GB200 R200x120 gear box (medium) DALI	139-2622	75	120	229	200	
--	----------	----	-----	-----	-----	--

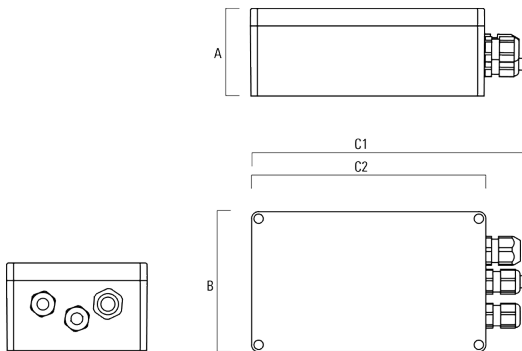

**FLC201 LED [FP]**

Description	Part ID	A	B	C1	C2	Weight (kg)
GB200 R230x140 gear box (large) SP10 DALI	139-2621	95	140	259	230	

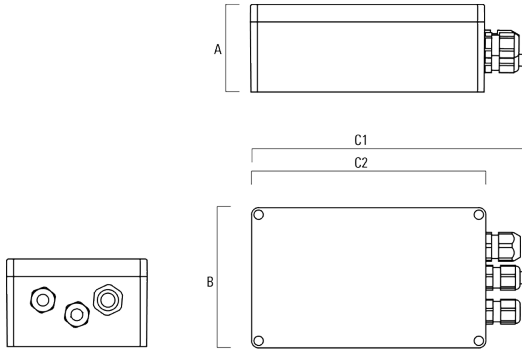

## Mounting Accessories

### Junction box

Description	Part ID	A	B	C1	C2
JB200 R82 Junction box	139-2590	55	82	140	80



**139-2754\_max**

**FLC201 LED [FP]**

**WE-EF LIGHTING Pty Ltd**

6/13 Downard Street, 3195 Braeside, Victoria

Phone: +61 3 8587 0444

Fax: +61 3 8587 0499

info.australia@we-ef.com

<https://we-ef.com/aus>

Subject to technical changes and errors.

Generated on 23/10/2024