

105-9771

RMC320 LED

we-ef



Description

IP66, Class I. IK08. Marine-grade, die-cast aluminium alloy. 5CE superior corrosion protection including PCS hardware. Silicone CCG® Controlled Compression Gasket. RFC™ Reflection Free Contour main lens.

Integral electronic converter with DALI interface. CAD-optimised optics for superior illumination and glare control. OLC® One LED Concept. Factory installed LED circuit board. The luminaire is factory-sealed and does not need to be opened during installation. Optional 2200 K version up to max. 1050mA available. To be specified at time of ordering.

Including 0.5 m cable with a cable connector.

Maximum spacing for streetlighting applications depends on wattage and light distribution: 5.5 to 9 times the mounting height.

Wild-Light options available on request.

Weight	7.50 kg
Light distribution	asymmetric, side throw [S60]
Light source	LED-18/18W / 350 mA - 3000 K
CRI	80
Power supply	EC
BUG	B1 U0 G1
LEDs	18
Rated input power	21 W

Nominal Lumen (lm)

LED Lumen	155
Total Lumen	2790
Tj	85

Rated lumens (lm)

LED Lumen	137.7
Total Lumen	2477.7
Ta	25

WE-EF LIGHTING (Thailand) Co., Ltd.

57 Moo 5, Kingkaew Rd., Bangplee, 10540 Samutprakarn - Phone: +66 2 738 96 20 - Fax: +66 2 738 96 29

<https://we-ef.com/asia>

Subject to technical changes and errors. - Generated on 05/10/2025

105-9771



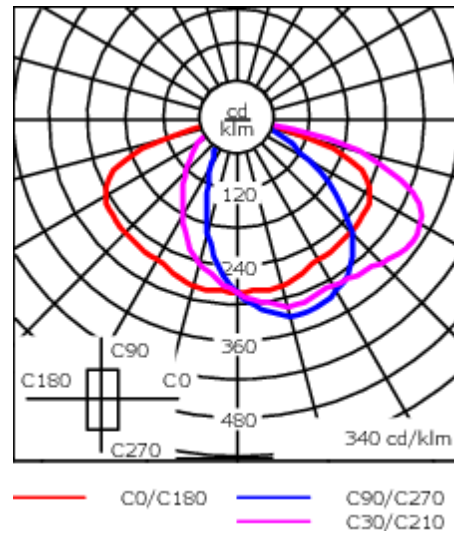
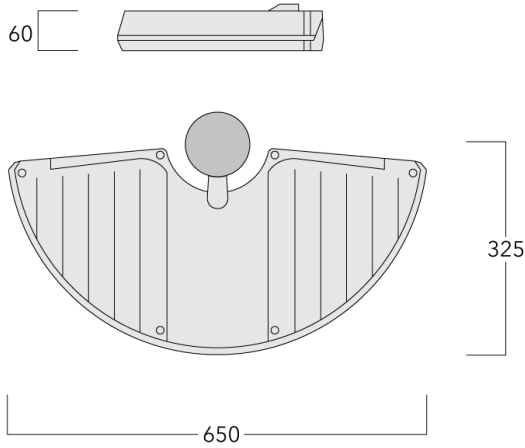

RMC320 LED

we-ef



Specifications

Material description

Body	Marine-grade, die-cast aluminium alloy
Lens	RFC™ Reflection Free Contour main lens
Colours	 RAL9004 Signal black  RAL9007 Grey aluminium  RAL7016 Anthracite grey  RAL9016 Traffic white
Gasket	Silicone CCG® Controlled Compression Gasket
Fasteners	PCS hardware
Ingress protection	IP66
Impact resistance	IK08
Corrosion resistance	5CE

Electrical description

Power supply	220-240V / 50-60 Hz
Driver / Ballast	Integral electronic converter with DALI interface
Power factor	> 0.9

Additional information

Lifetime	Ta=25° L90B10 > 90000h
BUG Rating	Please see individual Spec Sheets for classification of Backlight, Uplight and Glare

WE-EF LIGHTING (Thailand) Co., Ltd.

57 Moo 5, Kingkaew Rd., Bangplee, 10540 Samutprakarn - Phone: +66 2 738 96 20 - Fax: +66 2 738 96 29

<https://we-ef.com/asia>

Subject to technical changes and errors. - Generated on 05/10/2025

Mounting Accessories

Wall and pole brackets RM

Description	Part ID	C1	C2	C3	D1	D × L1	H1	H2	M1	Weight (kg)
Pole bracket RM1-76, single for mounting on AMF-C poles	105-9849				114	76 x 80				1.20

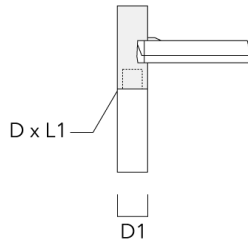

Pole bracket RM2-76, double for mounting on AMF-C poles	105-9850				114	76 x 80				1.30
---	----------	--	--	--	-----	---------	--	--	--	------

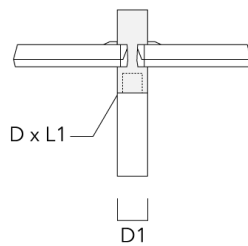

Description	Part ID	C1	C2	C3	D1	D × L1	H1	H2	M1	Weight (kg)
Pole bracket RM1-76, single for mounting on AMW-C poles	105-9847				102	76 x 80				1.00

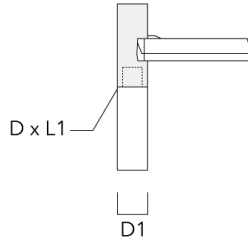

Short bracket RM1-S	105-9845	50			≥ 76		150	124	11	0.60
---------------------	----------	----	--	--	-----------	--	-----	-----	----	------

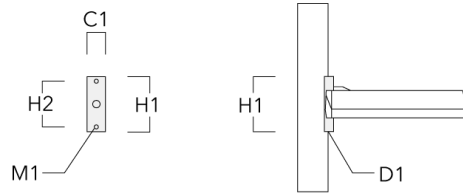

Description	Part ID	C1	C2	C3	D1	D × L1	H1	H2	M1	Weight (kg)
Wall bracket RM1-W	105-9846	375	105	80			175	155	6	1.30



Pole bracket RM2-76, double for mounting on AMW-C poles	105-9848				102	76 x 80				1.00
---	----------	--	--	--	-----	---------	--	--	--	------

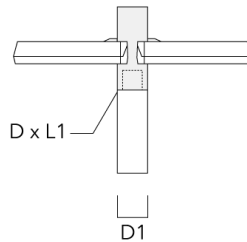

105-9771

RMC320 LED

we-ef

Control

R2C Ready to Connect

Description	Part ID
R2C Ready to Connect (top)	430-0019

WE-EF LIGHTING (Thailand) Co., Ltd.

57 Moo 5, Kingkaew Rd., Bangplee, 10540 Samutprakarn - Phone: +66 2 738 96 20 - Fax: +66 2 738 96 29

<https://we-ef.com/asia>

Subject to technical changes and errors. - Generated on 05/10/2025