



#### Description

IP66, Class I or Class II. IK08. Marine-grade, die-cast aluminium alloy. 5CE superior corrosion protection including PCS hardware. Silicone CCG® Controlled Compression Gasket. RFC® Reflection Free Contour main lens. Integral EC electronic converter. DALI. CAD-optimised OLC® One LED Concept optics for superior illumination and glare control. Factory installed LED circuit board. The luminaire is factory-sealed and does not need to be opened during installation.

Optional 2200 K version up to max. 1050mA available. To be specified at time of ordering.

The optional brackets RM are required for mounting. To be ordered separately.

|                           |                                   |
|---------------------------|-----------------------------------|
| Weight                    | 7.50 kg                           |
| Light distribution        | asymmetric, side throw beam [S60] |
| Light source              | LED-18/18W / 350 mA - 4000 K      |
| CRI                       | 80                                |
| Power supply              | EC                                |
| LEDs                      | 18                                |
| Rated input power         | 21 W                              |
| <b>Nominal Lumen (lm)</b> |                                   |
| LED Lumen                 | 170                               |
| Total Lumen               | 3060                              |
| Tj                        | 85                                |
| <b>Rated lumens (lm)</b>  |                                   |
| LED Lumen                 | 151                               |
| Total Lumen               | 2717.5                            |
| Ta                        | 25                                |

105-9775



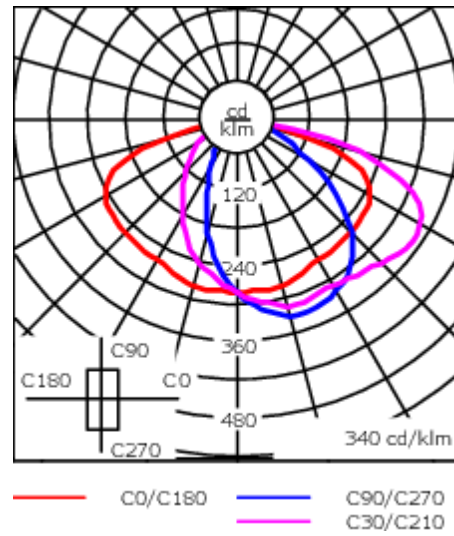
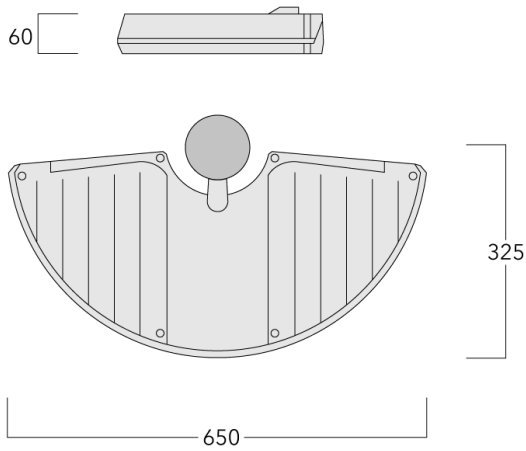

RMC320 LED

we-ef



## Specifications

### Material description

|                      |   |
|----------------------|---|
| Body                 | Marine-grade, die-cast aluminium alloy  |
| Lens                 | RFC® Reflection Free Contour technology   |
| Colours              |  RAL9004 Signal black<br> RAL9006 White aluminium<br> RAL9007 Grey aluminium<br> RAL7016 Anthracite grey<br> RAL9016 Traffic white |
| Gasket               | Silicone CCG® Controlled Compression Gasket   |
| Fasteners            | PCS Polymer Coated Stainless Steel Hardware   |
| Ingress protection   | IP66  |
| Impact resistance    | IK08  |
| Corrosion resistance | 5CE   |
| Windage              | 0.046 m <sup>2</sup>  |

### Electrical description

|                  |  |
|------------------|--|
| Power supply     | 220-240V / 50-60 Hz                    |
| Driver / Ballast | Integral EC electronic converter. DALI |
| Power factor     | > 0.9                                  |
| Surge protection | 6/6 kV (optional SP10)                 |

#### Fagerhult Lighting Ltd

33-34 Dolben Street, SE1 0UQ London, United Kingdom

<https://we-ef.com/uk>

Subject to technical changes and errors. - Generated on 23/11/2024

**105-9775**

**RMC320 LED**

**we-ef**

**Additional information**

---

Lifetime Ta=25° L90B10 > 90000h

Energy efficiency class C-D (Light source)

---

**Fagerhult Lighting Ltd**

33-34 Dolben Street, SE1 0UQ London, United Kingdom

<https://we-ef.com/uk>

Subject to technical changes and errors. - Generated on 23/11/2024

**105-9775**

**RMC320 LED**

**we-ef**

## **Control**

### **Eco Step Dim® Basic**

| Description             | Part ID  |
|-------------------------|----------|
| Eco Step Dim® Basic LED | 430-0001 |

### **Eco Step Dim® Advanced**

| Description                | Part ID  |
|----------------------------|----------|
| Eco Step Dim® Advanced LED | 430-0002 |

**Fagerhult Lighting Ltd**

33-34 Dolben Street, SE1 0UQ London, United Kingdom

<https://we-ef.com/uk>

Subject to technical changes and errors. - Generated on 23/11/2024

**Mounting Accessories**

**Wall and pole brackets RM**

| Description                 | Part ID  | C1 | C2 | C3 | D1  | D × L1  | H1 | H2 | M1 | Weight (kg) |
|-----------------------------|----------|----|----|----|-----|---------|----|----|----|-------------|
| RM1-76 Pole bracket, single | 105-9847 |    |    |    | 102 | 76 x 80 |    |    |    | 1.00        |

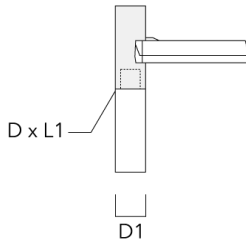

|                           |          |    |  |  |      |  |     |     |    |      |
|---------------------------|----------|----|--|--|------|--|-----|-----|----|------|
| RM1-S Pole bracket, short | 105-9845 | 50 |  |  | ≥ 76 |  | 150 | 124 | 11 | 0.60 |
|---------------------------|----------|----|--|--|------|--|-----|-----|----|------|

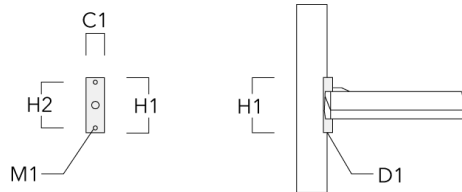

| Description                | Part ID  | C1  | C2  | C3 | D1 | D × L1 | H1  | H2  | M1 | Weight (kg) |
|----------------------------|----------|-----|-----|----|----|--------|-----|-----|----|-------------|
| RM1-W Wall bracket, single | 105-9846 | 375 | 105 | 80 |    |        | 175 | 155 | 6  | 1.30        |

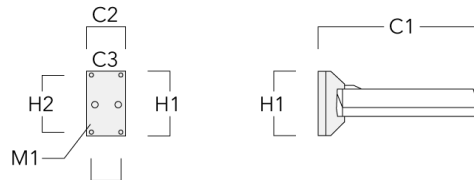

|                             |          |  |  |  |     |         |  |  |  |      |
|-----------------------------|----------|--|--|--|-----|---------|--|--|--|------|
| RM2-76 Pole bracket, double | 105-9848 |  |  |  | 102 | 76 x 80 |  |  |  | 1.00 |
|-----------------------------|----------|--|--|--|-----|---------|--|--|--|------|

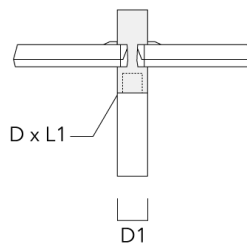

**105-9775**

**RMC320 LED**

**we-ef**

## **Optical Accessories**

### **Light shield**

| Description | Part ID  | Additional information  |
|-------------|----------|---|
| LS180-[A60] | 430-0038 | Light shield LS180 to greatly reduce or eliminate light pollution.<br>PA injection moulded component, black matt.<br>Suitable for asymmetric light distribution [A60].                          |
| LS180       | 430-0029 | Glare Shield for backlight spill. Glare Shield factory-installed or available as retrofit kit.<br>Suitable for [S60], [S65], [S70], [R65], [P65] lenses. Must be specified at time of ordering. |