

105-9776

RMC320 LED

we-ef

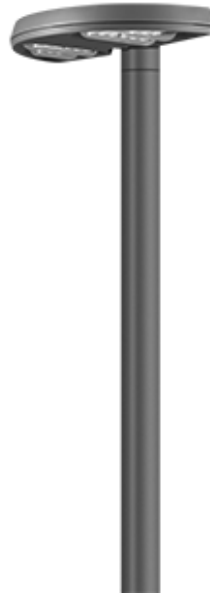

Description

Surface-mounted wall luminaire.

IP66. Class I. IK07. Marine-grade, die-cast aluminum alloy. 5CE superior corrosion protection including PCS hardware. Silicone CCG® Controlled Compression Gasket. Safety glass lens. Two cable entries. CAD-optimized optics for superior illumination and glare control. Integral driver. OLC® One LED Concept. Factory-installed LED circuit board. 0-10V Dimming comes standard with luminaire.

Suitable for Up, Down, or Up/Down light distribution. Suitable for installation over 4" recessed junction box. Emergency Lighting Package option available; to be specified as accessory with order.

Specify product with 7 Digit product code - Finish Color. Accessories, such as mounting, optical, and electrical, must be specified separately.

Example: XXX-XXXX-9004 (Black)
+ XXX-XXXX (Accessory 1)

Weight	16.50 lb
Light distribution	[S60] Type III Short
Light source	LED-18/36W / 700 mA - 4000 K
CRI	80
Power supply	electronic gear
BUG	B1 U0 G1
LEDs	18
Rated input power	41 W

Nominal Lumen (lm)

LED Lumen	310
Total Lumen	5580
Tj	85

Rated lumens (lm)

LED Lumen	262.2
Total Lumen	4719.6
Ta	25

WE-EF LIGHTING USA, LLC

410-D Keystone Drive, 15086 Warrendale, PA 15086 - Phone: +1 724 742 0030
customersupport.usa@we-ef.com - <https://we-ef.com/us>
Subject to technical changes and errors. - Generated on 11/23/2024

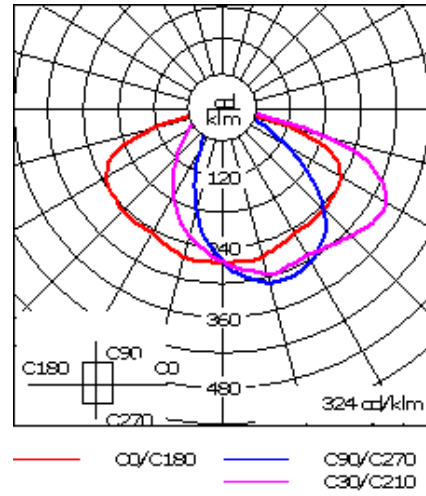
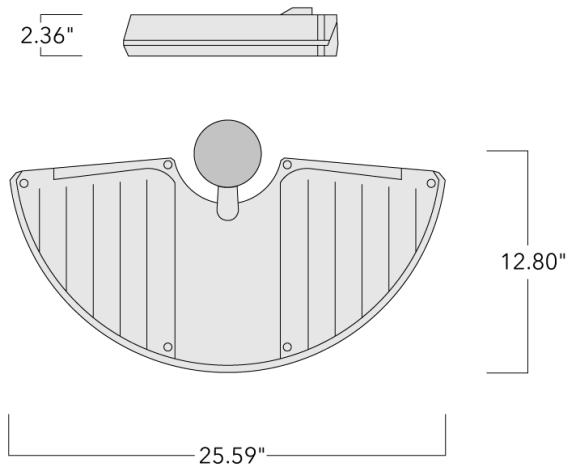

Specifications
Material description

Body	Marine-grade die-cast aluminium alloy
Lens	PMMA RFC® Reflection Free Contour technology
Colors	<div style="display: flex; flex-direction: column; gap: 5px;"> <div> RAL9004 Black</div> <div> RAL9007 Grey Metallic</div> <div> RAL9016 White</div> <div> RAL8019 Dark Bronze</div> </div>
Gasket	Silicone rubber gasket
Fasteners	PCS Polymer Coated Stainless Steel hardware
Ingress protection	IP66
Impact resistance	IK08
Corrosion resistance	5CE
Windage	0.4

105-9776

RMC320 LED

we-ef

Electrical description

Power supply	Integral [ECG] electronic driver 120V-277V. 0-10V dimmable, to be specified with order.
Driver / Ballast	Integral EC electronic converter
Power factor	> 0.9
Surge protection	Integral 10kV Surge Protector

Additional information

Lifetime	Ta=25°/40° L90B10 > 90000h
BUG Rating	Please see individual Spec Sheets for classification of Backlight, Uplight and Glare.
Listings	ETL, UL-1598, CSA-C22.2#250.0. Suitable for Wet Locations.

WE-EF LIGHTING USA, LLC

410-D Keystone Drive, 15086 Warrendale, PA 15086 - Phone: +1 724 742 0030
customersupport.usa@we-ef.com - <https://we-ef.com/us>
Subject to technical changes and errors. - Generated on 11/23/2024

Mounting Accessories

Wall and pole brackets RM

Description	Part ID	C1	C2	C3	D1	D × L1	H1	H2	M1	Weight (lb)
RM1-76 (OD=102)	105-9847				4	3 x 3				2.20

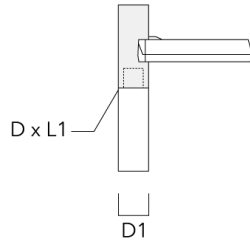

RM1-S	105-9845	1.97			≥ 2.99		5.90	4.88	0.43	1.30
-------	----------	------	--	--	--------	--	------	------	------	------

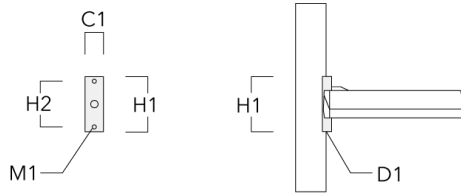

105-9776
RMC320 LED

Description	Part ID	C1	C2	C3	D1	D × L1	H1	H2	M1	Weight (lb)
RM1-W	105-9846	14.72	4.17	3.15			6.93	6.10	0.24	2.90

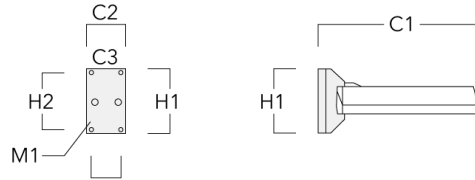

RM2-76 (OD=102)	105-9848				4	3 x 3				2.20
-----------------	----------	--	--	--	---	-------	--	--	--	------

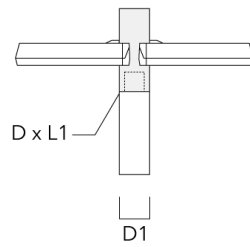

WE-EF LIGHTING USA, LLC

410-D Keystone Drive, 15086 Warrendale, PA 15086 - Phone: +1 724 742 0030
 customersupport.usa@we-ef.com - <https://we-ef.com/us>
 Subject to technical changes and errors. - Generated on 11/23/2024

105-9776

RMC320 LED

we-ef

Optical Accessories

Light shield

Description	Part ID	Additional information
LS180-[A60]	430-0038	Light shield LS180 to greatly reduce or eliminate light pollution. PA injection moulded component, black matt. Suitable for asymmetric light distribution [A60].
LS180	430-0029	Glare Shield for backlight spill. Glare Shield factory-installed or available as retrofit kit. Suitable for [S60], [S65], [S70], [R65], [P65] lenses. Must be specified at time of ordering.

WE-EF LIGHTING USA, LLC

410-D Keystone Drive, 15086 Warrendale, PA 15086 - Phone: +1 724 742 0030
customersupport.usa@we-ef.com - <https://we-ef.com/us>

Subject to technical changes and errors. - Generated on 11/23/2024