

105-9777

RMC320 LED

we-ef



Description

IP66, Class I or Class II. IK08. Marine-grade, die-cast aluminium alloy. 5CE superior corrosion protection including PCS hardware. Silicone CCG® Controlled Compression Gasket. RFC® Reflection Free Contour main lens. Integral EC electronic converter. DALI. CAD-optimised OLC® One LED Concept optics for superior illumination and glare control. Factory installed LED circuit board. The luminaire is factory-sealed and does not need to be opened during installation.

Optional 2200 K version up to max. 1050mA available. To be specified at time of ordering.

The optional brackets RM are required for mounting. To be ordered separately.

| | |
|--------------------|-----------------------------------|
| Weight | 7.50 kg |
| Light distribution | asymmetric, side throw beam [S60] |
| Light source | LED-18/54W / 1050 mA - 4000 K |
| CRI | 80 |
| Power supply | EC |
| LEDs | 18 |
| Rated input power | 59 W |

Nominal Lumen (lm)

| | |
|-------------|------|
| LED Lumen | 450 |
| Total Lumen | 8100 |
| Tj | 85 |

Rated lumens (lm)

| | |
|-------------|--------|
| LED Lumen | 395.9 |
| Total Lumen | 7127.1 |
| Ta | 25 |

Fagerhult Lighting Ltd

33-34 Dolben Street, SE1 0UQ London, United Kingdom

<https://we-ef.com/uk>

Subject to technical changes and errors. - Generated on 23/11/2024

105-9777



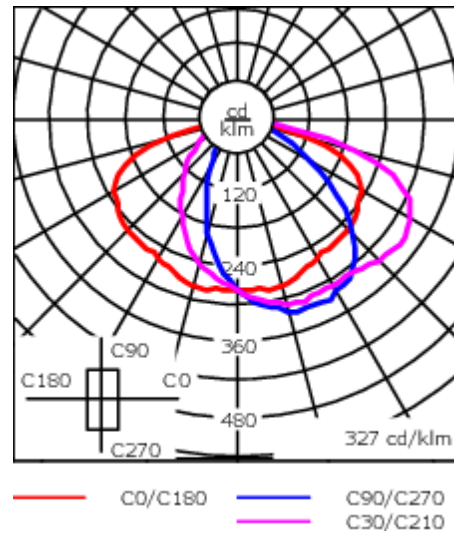
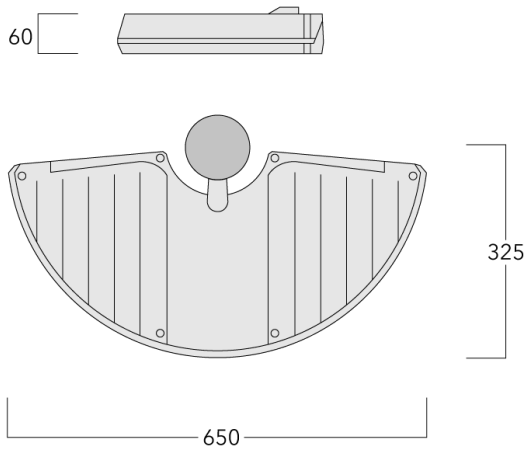

RMC320 LED

we-ef



Specifications

Material description

| | |
|----------------------|---|
| Body | Marine-grade, die-cast aluminium alloy |
| Lens | RFC® Reflection Free Contour technology |
| Colours |  RAL9004 Signal black  RAL9006 White aluminium  RAL9007 Grey aluminium  RAL7016 Anthracite grey  RAL9016 Traffic white |
| Gasket | Silicone CCG® Controlled Compression Gasket |
| Fasteners | PCS Polymer Coated Stainless Steel Hardware |
| Ingress protection | IP66 |
| Impact resistance | IK08 |
| Corrosion resistance | 5CE |
| Windage | 0.046 m ² |

Electrical description

| | |
|------------------|--|
| Power supply | 220-240V / 50-60 Hz |
| Driver / Ballast | Integral EC electronic converter. DALI |
| Power factor | > 0.9 |
| Surge protection | 6/6 kV (optional SP10) |

Fagerhult Lighting Ltd

33-34 Dolben Street, SE1 0UQ London, United Kingdom

<https://we-ef.com/uk>

Subject to technical changes and errors. - Generated on 23/11/2024

105-9777

RMC320 LED

we-ef

Additional information

Lifetime Ta=25° L90B10 > 90000h

Energy efficiency class C-D (Light source)

Fagerhult Lighting Ltd

33-34 Dolben Street, SE1 0UQ London, United Kingdom

<https://we-ef.com/uk>

Subject to technical changes and errors. - Generated on 23/11/2024

105-9777

RMC320 LED

we-ef

Control

Eco Step Dim® Basic

| Description | Part ID |
|-------------------------|----------|
| Eco Step Dim® Basic LED | 430-0001 |

Eco Step Dim® Advanced

| Description | Part ID |
|----------------------------|----------|
| Eco Step Dim® Advanced LED | 430-0002 |

Fagerhult Lighting Ltd

33-34 Dolben Street, SE1 0UQ London, United Kingdom

<https://we-ef.com/uk>

Subject to technical changes and errors. - Generated on 23/11/2024

Mounting Accessories

Wall and pole brackets RM

| Description | Part ID | C1 | C2 | C3 | D1 | D × L1 | H1 | H2 | M1 | Weight (kg) |
|-----------------------------|----------|----|----|----|-----|---------|----|----|----|-------------|
| RM1-76 Pole bracket, single | 105-9847 | | | | 102 | 76 x 80 | | | | 1.00 |

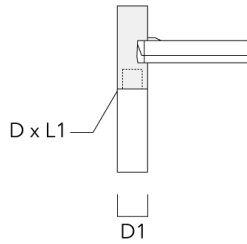

| | | | | | | | | | | |
|---------------------------|----------|----|--|--|------|--|-----|-----|----|------|
| RM1-S Pole bracket, short | 105-9845 | 50 | | | ≥ 76 | | 150 | 124 | 11 | 0.60 |
|---------------------------|----------|----|--|--|------|--|-----|-----|----|------|

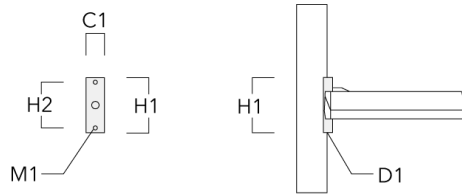

| Description | Part ID | C1 | C2 | C3 | D1 | D × L1 | H1 | H2 | M1 | Weight (kg) |
|----------------------------|----------|-----|-----|----|----|--------|-----|-----|----|-------------|
| RM1-W Wall bracket, single | 105-9846 | 375 | 105 | 80 | | | 175 | 155 | 6 | 1.30 |

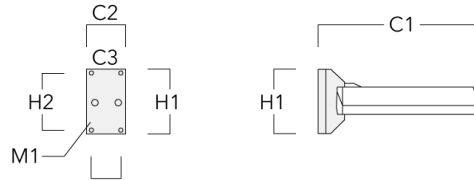

| | | | | | | | | | | |
|-----------------------------|----------|--|--|--|-----|---------|--|--|--|------|
| RM2-76 Pole bracket, double | 105-9848 | | | | 102 | 76 x 80 | | | | 1.00 |
|-----------------------------|----------|--|--|--|-----|---------|--|--|--|------|

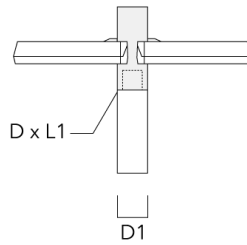

Optical Accessories**Light shield**

| Description | Part ID | Additional information |
|-------------|----------|---|
| LS180-[A60] | 430-0038 | Light shield LS180 to greatly reduce or eliminate light pollution. PA injection moulded component, black matt. Suitable for asymmetric light distribution [A60]. |
| LS180 | 430-0029 | Glare Shield for backlight spill. Glare Shield factory-installed or available as retrofit kit. Suitable for [S60], [S65], [S70], [R65], [P65] lenses. Must be specified at time of ordering. |