

145-7603

FLC311 Spigot mounted

**we-ef**



#### Description

IP66. IK08. Marine-grade, die-cast aluminium alloy. 5CE superior corrosion protection including PCS hardware. Safety glass lens. Silicone CCG® Controlled Compression Gasket. Luminaire is factory-sealed and does not need to be opened during installation.

Integral EC electronic converter. Advanced thermal management protects LEDs while optimising lumens output. CAD-optimised optics for superior illumination and glare control. Including 1.5 m of flexible PVC free cable.

Mains voltage versions, DALI interface Class I. 1-10 V analogue dimming available on request; refer to accessory listings.

DALI Class II, refer to accessory listings. 0-10 V Class II available on request.

24VDC low voltage versions, 0-10 V Class III.

Remote 24VDC power supply to be ordered separately.

|                    |                            |
|--------------------|----------------------------|
| Weight             | 1.60 kg                    |
| Light distribution | symmetric, wide beam [B]   |
| Light source       | LED-3/6W / 180 mA - 3000 K |
| CRI                | 80                         |
| Power supply       | EC                         |
| LEDs               | 3                          |
| Rated input power  | 7.5 W                      |

#### Nominal Lumen (lm)

|             |     |
|-------------|-----|
| LED Lumen   | 260 |
| Total Lumen | 780 |
| Tj          | 85  |

#### Rated lumens (lm)

|             |       |
|-------------|-------|
| LED Lumen   | 198.5 |
| Total Lumen | 595.4 |
| Ta          | 25    |

**WE-EF LIGHTING (Thailand) Co., Ltd.**

57 Moo 5, Kingkaew Rd., Bangplee, 10540 Samutprakarn - Phone: +66 2 738 96 20 - Fax: +66 2 738 96 29

<https://we-ef.com/asia>

Subject to technical changes and errors. - Generated on 23/11/2024

145-7603





FLC311 Spigot mounted

we-ef



## Specifications

### Material description

|                      |                                                                                                                                                                                                                                                                                                                                                                                                                                                    |
|----------------------|----------------------------------------------------------------------------------------------------------------------------------------------------------------------------------------------------------------------------------------------------------------------------------------------------------------------------------------------------------------------------------------------------------------------------------------------------|
| Body                 | Marine-grade, die-cast aluminium alloy                                                                                                                                                                                                                                                                                                                                                                                                             |
| Lens                 | Safety glass lens                                                                                                                                                                                                                                                                                                                                                                                                                                  |
| Colours              |  RAL9004 Signal black<br> RAL9007 Grey aluminium<br> RAL7016 Anthracite grey<br> RAL9016 Traffic white |
| Gasket               | Silicone CCG® Controlled Compression Gasket                                                                                                                                                                                                                                                                                                                                                                                                        |
| Fasteners            | PCS hardware                                                                                                                                                                                                                                                                                                                                                                                                                                       |
| Ingress protection   | IP66                                                                                                                                                                                                                                                                                                                                                                                                                                               |
| Impact resistance    | IK08                                                                                                                                                                                                                                                                                                                                                                                                                                               |
| Corrosion resistance | 5CE                                                                                                                                                                                                                                                                                                                                                                                                                                                |
| Windage              | 0.020 m <sup>2</sup>                                                                                                                                                                                                                                                                                                                                                                                                                               |

### Electrical description

|                  |                |
|------------------|----------------|
| Driver / Ballast | DALI interface |
| Power factor     | >0.9           |

### Additional information

|          |                                     |
|----------|-------------------------------------|
| Lifetime | T <sub>a</sub> =25° L90B10 > 90000h |
|----------|-------------------------------------|

WE-EF LIGHTING (Thailand) Co., Ltd.

57 Moo 5, Kingkaew Rd., Bangplee, 10540 Samutprakarn - Phone: +66 2 738 96 20 - Fax: +66 2 738 96 29

<https://we-ef.com/asia>

Subject to technical changes and errors. - Generated on 23/11/2024

**FLC311 Spigot mounted**

**Mounting Accessories**

**Flat surface and Column fitter**

| Description          | Part ID  | A  | B | Weight (kg) |
|----------------------|----------|----|---|-------------|
| Column fitter FLC300 | 145-9536 | 70 |   | 0.20        |



|                            |          |     |    |      |
|----------------------------|----------|-----|----|------|
| Flat surface fitter FLC300 | 145-9535 | 100 | 85 | 0.20 |
|----------------------------|----------|-----|----|------|

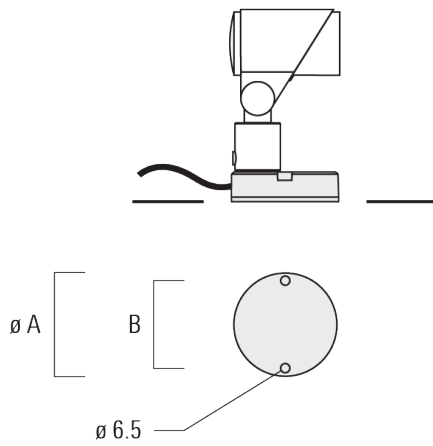

**FLC311 Spigot mounted**

**Ground spike**

| Description                 | Part ID  | A   | Weight (kg) |
|-----------------------------|----------|-----|-------------|
| Ground spike EF1 for FLC300 | 310-9102 | 270 | 1.20        |



**Junction box**

| Description                      | Part ID  | A   | B  | C1  | D1 | Weight (kg) |
|----------------------------------|----------|-----|----|-----|----|-------------|
| Junction box JB1 with side entry | 310-9002 | 107 | 67 | 135 | 67 | 1.20        |



**FLC311 Spigot mounted**

| Description                      | Part ID  | A   | B  | C1  | D1 | Weight (kg) |
|----------------------------------|----------|-----|----|-----|----|-------------|
| Junction box JB1 with wall entry | 310-9025 | 107 | 67 | 135 | 67 | 1.10        |



|                                               |          |     |    |     |    |      |
|-----------------------------------------------|----------|-----|----|-----|----|------|
| Junction box JB1 with side entry<br>(conduit) | 310-9022 | 107 | 67 | 135 | 67 | 1.20 |
|-----------------------------------------------|----------|-----|----|-----|----|------|

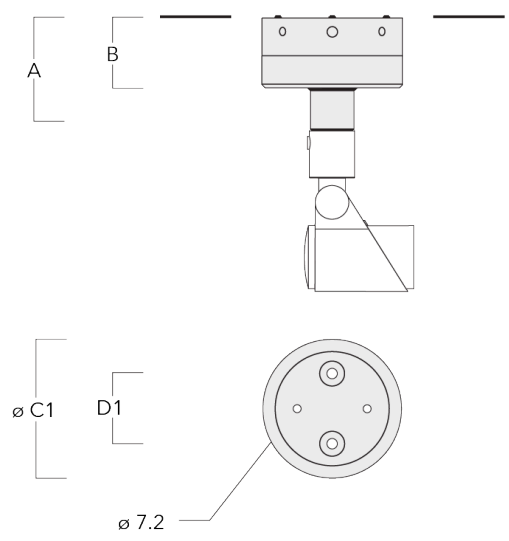

**145-7603**

**FLC311 Spigot mounted**

**we-ef**

## **Control**

### **1-10 V analogue dimming interface**

| Description                       | Part ID  |
|-----------------------------------|----------|
| 1-10 V analogue dimming interface | 430-0011 |

### **DALI interface**

| Description   | Part ID   |
|---------------|-----------|
| DALI Class II | 0043+0013 |

### **0-10 V, 24VDC low voltage version**

| Description                       | Part ID |
|-----------------------------------|---------|
| 24VDC low voltage version, 0-10 V | 0033    |

145-7603

FLC311 Spigot mounted

**we-ef**

## Optical Accessories

### Flood lens

---

| Description                | Part ID  | C1 |
|----------------------------|----------|----|
| Flood lens IO-360 for [EE] | 145-7786 | 59 |

---



---

|                             |          |    |
|-----------------------------|----------|----|
| Flood lens IO-360 for [EES] | 145-7780 | 59 |
|-----------------------------|----------|----|

---



**WE-EF LIGHTING (Thailand) Co., Ltd.**

57 Moo 5, Kingkaew Rd., Bangplee, 10540 Samutprakarn - Phone: +66 2 738 96 20 - Fax: +66 2 738 96 29

<https://we-ef.com/asia>

Subject to technical changes and errors. - Generated on 23/11/2024

145-7603

**we-ef**

**FLC311 Spigot mounted**

**Linear spread lens**

---

| Description               | Part ID  | C1 |
|---------------------------|----------|----|
| Linear spread lens IO-180 | 145-7781 | 59 |

---

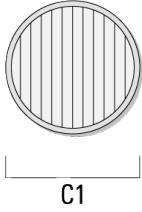

---

**Wallwash lens**

---

| Description         | Part ID  | C1 |
|---------------------|----------|----|
| Wallwash lens IO-20 | 145-7782 | 59 |

---

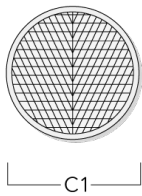

**WE-EF LIGHTING (Thailand) Co., Ltd.**

57 Moo 5, Kingkaew Rd., Bangplee, 10540 Samutprakarn - Phone: +66 2 738 96 20 - Fax: +66 2 738 96 29

<https://we-ef.com/asia>

Subject to technical changes and errors. - Generated on 23/11/2024



**FLC311 Spigot mounted**

**Honeycomb louvre**

| Description         | Part ID  | C1 |  |
|---------------------|----------|----|--|
| Honeycomb louvre IW | 145-7783 | 59 |  |



**Glare shield**

| Description     | Part ID  | A  | C1 |
|-----------------|----------|----|----|
| Glare shield ES | 145-7784 | 34 | 85 |



145-7603

**we-ef**

FLC311 Spigot mounted

**Snoot**

---

| Description | Part ID  | A  | C1 |
|-------------|----------|----|----|
| Snoot ET    | 145-7785 | 34 | 85 |

---



**WE-EF LIGHTING (Thailand) Co., Ltd.**

57 Moo 5, Kingkaew Rd., Bangplee, 10540 Samutprakarn - Phone: +66 2 738 96 20 - Fax: +66 2 738 96 29

<https://we-ef.com/asia>

Subject to technical changes and errors. - Generated on 23/11/2024