

145-7602

FLC311 Spigot mounted

we-ef



Description

IP66. IK08. Marine-grade, die-cast aluminium alloy. 5CE superior corrosion protection including PCS hardware. Safety glass lens. Silicone CCG® Controlled Compression Gasket. Luminaire is factory-sealed and does not need to be opened during installation.

Integral EC electronic converter. Advanced thermal management protects LEDs while optimising lumens output. CAD-optimised optics for superior illumination and glare control. Including 1.5 m of flexible PVC free cable.

Mains voltage versions: DALI interface

24VDC low voltage versions: ON-OFF Class III.

Remote 24VDC power supply to be ordered separately.

| | |
|---------------------------|-----------------------------|
| Weight | 1.60 kg |
| Light distribution | symmetric, wide beam [B] |
| Light source | LED-3/12W / 350 mA - 2700 K |
| CRI | 80 |
| Power supply | EC |
| LEDs | 3 |
| Rated input power | 13.9 W |
| Nominal Lumen (lm) | |
| LED Lumen | 490 |
| Total Lumen | 1470 |
| Tj | 85 |
| Rated lumens (lm) | |
| LED Lumen | 374 |
| Total Lumen | 1122.1 |
| Ta | 25 |

WE-EF LIGHTING Pty Ltd

6/13 Downard Street, 3195 Braeside, Victoria - Phone: +61 3 8587 0444 - Fax: +61 3 8587 0499

info.australia@we-ef.com - <https://we-ef.com/aus>

Subject to technical changes and errors. - Generated on 27/11/2024

145-7602



FLC311 Spigot mounted

we-ef



Specifications

Material description

| | |
|----------------------|---------------------------------------------------------------------------------------------------------------------------------------------------------------------------------------------------------------------------------------------------------------------------------------------------------------------------------------|
| Body | Marine-grade, die-cast aluminium alloy |
| Lens | Safety glass lens |
| Colours |  RAL9004 Signal black  RAL9006 White aluminium  RAL9007 Grey aluminium |
| Gasket | Silicone CCG® Controlled Compression Gasket |
| Fasteners | PCS hardware |
| Ingress protection | IP66 |
| Impact resistance | IK08 |
| Corrosion resistance | 5CE |
| Windage | 0.020 m ² |

Electrical description

| | |
|------------------|------|
| Driver / Ballast | DALI |
| Power factor | >0.9 |

Additional information

| | |
|----------|------------------------|
| Lifetime | Ta=40° L90B10 > 90000h |
|----------|------------------------|

WE-EF LIGHTING Pty Ltd

6/13 Downard Street, 3195 Braeside, Victoria - Phone: +61 3 8587 0444 - Fax: +61 3 8587 0499

info.australia@we-ef.com - <https://we-ef.com/aus>

Subject to technical changes and errors. - Generated on 27/11/2024

145-7602

FLC311 Spigot mounted

we-ef

Control

Eco Step Dim® Advanced

| Description | Part ID |
|----------------------------|----------|
| Eco Step Dim® Advanced LED | 430-0002 |

0-10 V, 24VDC low voltage version

| Description | Part ID |
|-----------------------------------|---------|
| 24VDC low voltage version, 0-10 V | 0033 |

WE-EF LIGHTING Pty Ltd

6/13 Downard Street, 3195 Braeside, Victoria - Phone: +61 3 8587 0444 - Fax: +61 3 8587 0499

info.australia@we-ef.com - <https://we-ef.com/aus>

Subject to technical changes and errors. - Generated on 27/11/2024

FLC311 Spigot mounted

Mounting Accessories

Flat surface and Column fitter

| Description | Part ID | A | B | Weight (kg) |
|----------------------|----------|----|---|-------------|
| Column fitter FLC300 | 145-9536 | 70 | | 0.20 |



| | | | | |
|----------------------------|----------|-----|----|------|
| Flat surface fitter FLC300 | 145-9535 | 100 | 85 | 0.20 |
|----------------------------|----------|-----|----|------|

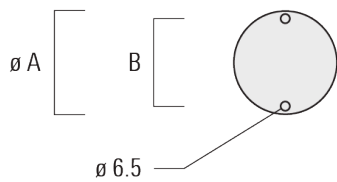

FLC311 Spigot mounted

Ground spike EF

| Description | Part ID | A | Weight (kg) |
|-----------------------------|----------|-----|-------------|
| Ground spike EF1 for FLC300 | 310-9102 | 270 | 1.20 |



Junction box JB1

| Description | Part ID | A | B | C1 | D1 | Weight (kg) |
|----------------------------------|----------|-----|----|-----|----|-------------|
| Junction box JB1 with side entry | 310-9002 | 107 | 67 | 135 | 67 | 1.20 |



FLC311 Spigot mounted

| Description | Part ID | A | B | C1 | D1 | Weight (kg) |
|----------------------------------|----------|-----|----|-----|----|-------------|
| Junction box JB1 with wall entry | 310-9025 | 107 | 67 | 135 | 67 | 1.10 |



| | | | | | | |
|-----------------------------------------------|----------|-----|----|-----|----|------|
| Junction box JB1 with side entry (conduit) | 310-9022 | 107 | 67 | 135 | 67 | 1.20 |
|-----------------------------------------------|----------|-----|----|-----|----|------|

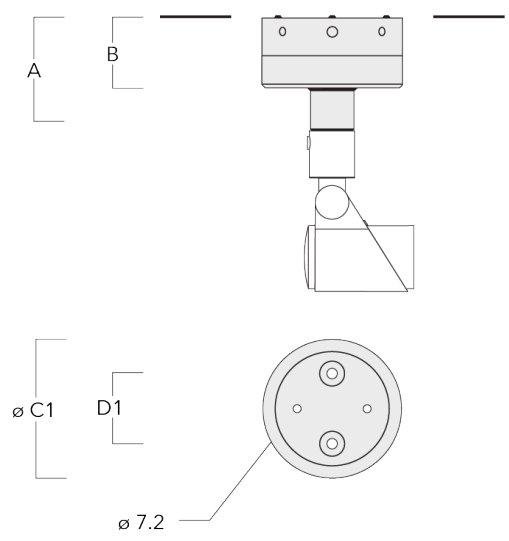

145-7602

FLC311 Spigot mounted

we-ef

Optical Accessories

Surface wash lens

| Description | Part ID | C1 |
|----------------------------|----------|----|
| Flood lens IO-360 for [EE] | 145-7786 | 59 |



| | | |
|-----------------------------|----------|----|
| Flood lens IO-360 for [EES] | 145-7780 | 59 |
|-----------------------------|----------|----|



WE-EF LIGHTING Pty Ltd

6/13 Downard Street, 3195 Braeside, Victoria - Phone: +61 3 8587 0444 - Fax: +61 3 8587 0499

info.australia@we-ef.com - <https://we-ef.com/aus>

Subject to technical changes and errors. - Generated on 27/11/2024

145-7602

we-ef

FLC311 Spigot mounted

Linear spread lens

| Description | Part ID | C1 |
|---------------------------|----------|----|
| Linear spread lens IO-180 | 145-7781 | 59 |

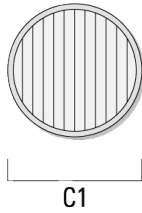

Wallwash lens

| Description | Part ID | C1 |
|---------------------|----------|----|
| Wallwash lens IO-20 | 145-7782 | 59 |

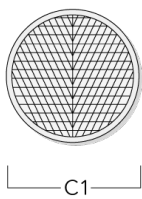

WE-EF LIGHTING Pty Ltd

6/13 Downard Street, 3195 Braeside, Victoria - Phone: +61 3 8587 0444 - Fax: +61 3 8587 0499

info.australia@we-ef.com - <https://we-ef.com/aus>

Subject to technical changes and errors. - Generated on 27/11/2024

FLC311 Spigot mounted

Honeycomb louvre

| Description | Part ID | C1 |
|---------------------|----------|----|
| Honeycomb louvre IW | 145-7783 | 59 |



Glare shield

| Description | Part ID | A | C1 |
|-----------------|----------|----|----|
| Glare shield ES | 145-7784 | 34 | 85 |



145-7602

we-ef

FLC311 Spigot mounted

Snoot

| Description | Part ID | A | C1 |
|-------------|----------|----|----|
| Snoot ET | 145-7785 | 34 | 85 |



WE-EF LIGHTING Pty Ltd

6/13 Downard Street, 3195 Braeside, Victoria - Phone: +61 3 8587 0444 - Fax: +61 3 8587 0499

info.australia@we-ef.com - <https://we-ef.com/aus>

Subject to technical changes and errors. - Generated on 27/11/2024