

145-7616

FLC311 Spigot mounted

we-ef



Description

IP66. IK08. Marine-grade, die-cast aluminium alloy. 5CE superior corrosion protection including PCS hardware. Safety glass lens. Silicone CCG® Controlled Compression Gasket. Luminaire is factory-sealed and does not need to be opened during installation.

Integral EC electronic converter. Advanced thermal management protects LEDs while optimising lumens output. CAD-optimised optics for superior illumination and glare control. Including 1.5 m of flexible PVC free cable.

Mains voltage versions: DALI interface

24VDC low voltage versions: ON-OFF Class III.

Remote 24VDC power supply to be ordered separately.

Weight	1.60 kg
Light distribution	symmetric, medium beam [M]
Light source	LED-3/9W / 250 mA - 4000 K
CRI	80
Power supply	EC
LEDs	3
Rated input power	11 W
Nominal Lumen (lm)	
LED Lumen	390
Total Lumen	1170
Tj	85
Rated lumens (lm)	
LED Lumen	300.2
Total Lumen	900.6
Ta	25

WE-EF LIGHTING Pty Ltd

6/13 Downard Street, 3195 Braeside, Victoria - Phone: +61 3 8587 0444 - Fax: +61 3 8587 0499

info.australia@we-ef.com - <https://we-ef.com/aus>

Subject to technical changes and errors. - Generated on 23/11/2024

145-7616



FLC311 Spigot mounted

we-ef



Specifications

Material description

Body	Marine-grade, die-cast aluminium alloy
Lens	Safety glass lens
Colours	 RAL9004 Signal black  RAL9006 White aluminium  RAL9007 Grey aluminium
Gasket	Silicone CCG® Controlled Compression Gasket
Fasteners	PCS hardware
Ingress protection	IP66
Impact resistance	IK08
Corrosion resistance	5CE
Windage	0.020 m ²

Electrical description

Driver / Ballast	DALI
Power factor	>0.9

Additional information

Lifetime	Ta=40° L90B10 > 90000h
----------	------------------------

WE-EF LIGHTING Pty Ltd

6/13 Downard Street, 3195 Braeside, Victoria - Phone: +61 3 8587 0444 - Fax: +61 3 8587 0499

info.australia@we-ef.com - <https://we-ef.com/aus>

Subject to technical changes and errors. - Generated on 23/11/2024

145-7616

FLC311 Spigot mounted

we-ef

Control

Eco Step Dim® Advanced

Description	Part ID
Eco Step Dim® Advanced LED	430-0002

0-10 V, 24VDC low voltage version

Description	Part ID
24VDC low voltage version, 0-10 V	0033

WE-EF LIGHTING Pty Ltd

6/13 Downard Street, 3195 Braeside, Victoria - Phone: +61 3 8587 0444 - Fax: +61 3 8587 0499

info.australia@we-ef.com - <https://we-ef.com/aus>

Subject to technical changes and errors. - Generated on 23/11/2024

FLC311 Spigot mounted

Mounting Accessories

Flat surface and Column fitter

Description	Part ID	A	B	Weight (kg)
Column fitter FLC300	145-9536	70		0.20

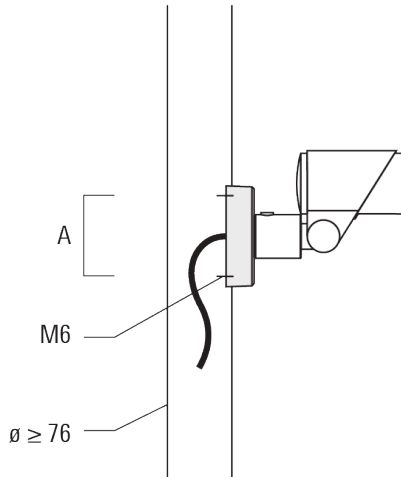

Flat surface fitter FLC300	145-9535	100	85	0.20
----------------------------	----------	-----	----	------

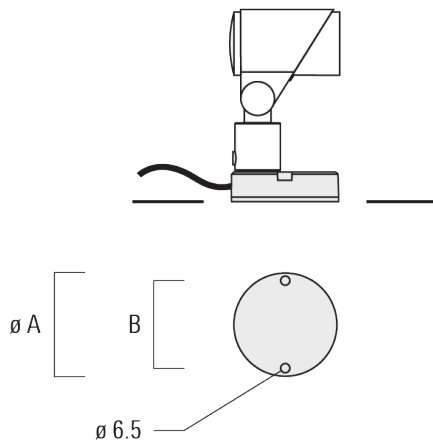

FLC311 Spigot mounted

Ground spike EF

Description	Part ID	A	Weight (kg)
Ground spike EF1 for FLC300	310-9102	270	1.20



Junction box JB1

Description	Part ID	A	B	C1	D1	Weight (kg)
Junction box JB1 with side entry	310-9002	107	67	135	67	1.20



FLC311 Spigot mounted

Description	Part ID	A	B	C1	D1	Weight (kg)
Junction box JB1 with wall entry	310-9025	107	67	135	67	1.10

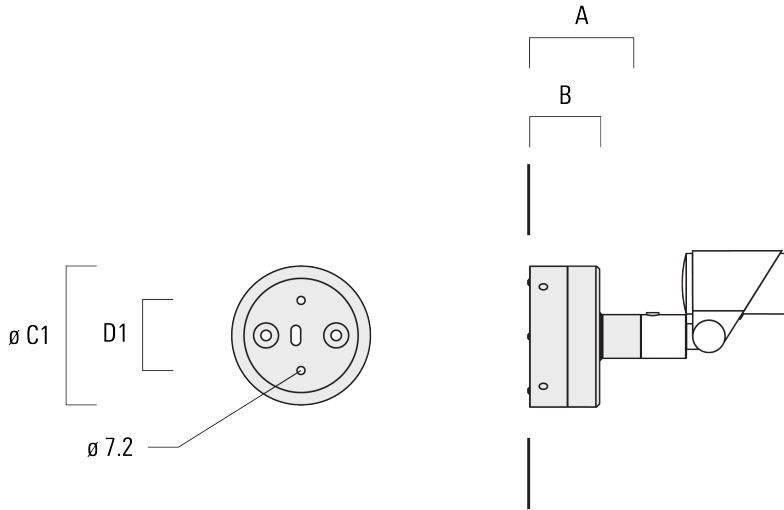

Junction box JB1 with side entry (conduit)	310-9022	107	67	135	67	1.20
---	----------	-----	----	-----	----	------

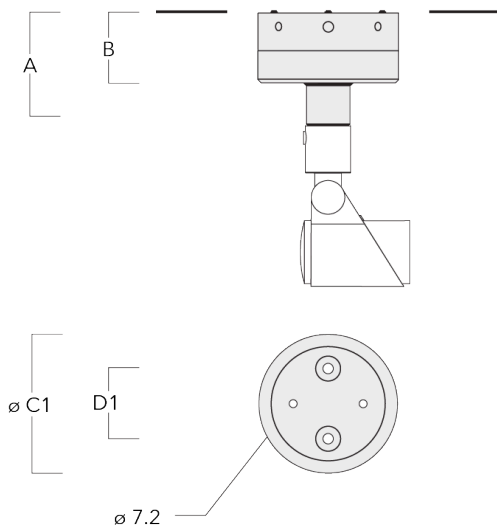

145-7616

FLC311 Spigot mounted

we-ef

Optical Accessories

Surface wash lens

Description	Part ID	C1
Flood lens IO-360 for [EE]	145-7786	59

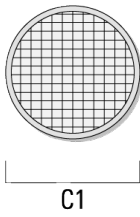

Flood lens IO-360 for [EES]	145-7780	59
-----------------------------	----------	----

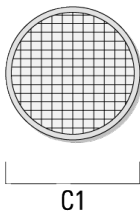

WE-EF LIGHTING Pty Ltd

6/13 Downard Street, 3195 Braeside, Victoria - Phone: +61 3 8587 0444 - Fax: +61 3 8587 0499

info.australia@we-ef.com - <https://we-ef.com/aus>

Subject to technical changes and errors. - Generated on 23/11/2024

145-7616

we-ef

FLC311 Spigot mounted

Linear spread lens

Description	Part ID	C1
Linear spread lens IO-180	145-7781	59

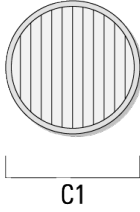

Wallwash lens

Description	Part ID	C1
Wallwash lens IO-20	145-7782	59

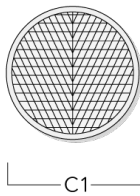

WE-EF LIGHTING Pty Ltd

6/13 Downard Street, 3195 Braeside, Victoria - Phone: +61 3 8587 0444 - Fax: +61 3 8587 0499

info.australia@we-ef.com - <https://we-ef.com/aus>

Subject to technical changes and errors. - Generated on 23/11/2024

FLC311 Spigot mounted

Honeycomb louvre

Description	Part ID	C1
Honeycomb louvre IW	145-7783	59

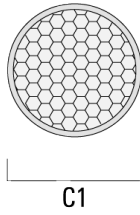

Glare shield

Description	Part ID	A	C1
Glare shield ES	145-7784	34	85

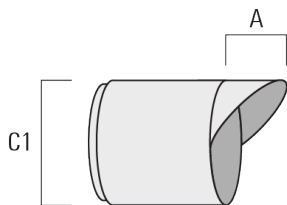

145-7616

we-ef

FLC311 Spigot mounted

Snoot

Description	Part ID	A	C1
Snoot ET	145-7785	34	85

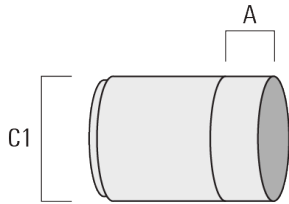

WE-EF LIGHTING Pty Ltd

6/13 Downard Street, 3195 Braeside, Victoria - Phone: +61 3 8587 0444 - Fax: +61 3 8587 0499

info.australia@we-ef.com - <https://we-ef.com/aus>

Subject to technical changes and errors. - Generated on 23/11/2024