

145-7616

FLC311 Spigot mounted

**we-ef**



#### Description

IP66. IK08. Marine-grade, die-cast aluminium alloy. 5CE superior corrosion protection including PCS hardware. Safety glass lens. Silicone CCG® Controlled Compression Gasket. Luminaire is factory-sealed and does not need to be opened during installation.

Integral EC electronic converter. Advanced thermal management protects LEDs while optimising lumens output. CAD-optimised optics for superior illumination and glare control. Including 1.5 m of flexible PVC free cable.

Mains voltage versions, DALI interface Class I. 1-10 V analogue dimming available on request; refer to accessory listings.

DALI Class II, refer to accessory listings. 0-10 V Class II available on request.

24VDC low voltage versions, 0-10 V Class III.

Remote 24VDC power supply to be ordered separately.

Weight	1.60 kg
Light distribution	symmetric, medium beam [M]
Light source	LED-3/9W / 250 mA - 4000 K
CRI	80
Power supply	EC
LEDs	3
Rated input power	11 W
<b>Nominal Lumen (lm)</b>	
LED Lumen	390
Total Lumen	1170
Tj	85
<b>Rated lumens (lm)</b>	
LED Lumen	300.2
Total Lumen	900.6
Ta	25

**WE-EF LIGHTING (Thailand) Co., Ltd.**

57 Moo 5, Kingkaew Rd., Bangplee, 10540 Samutprakarn - Phone: +66 2 738 96 20 - Fax: +66 2 738 96 29

<https://we-ef.com/asia>

Subject to technical changes and errors. - Generated on 23/11/2024

145-7616



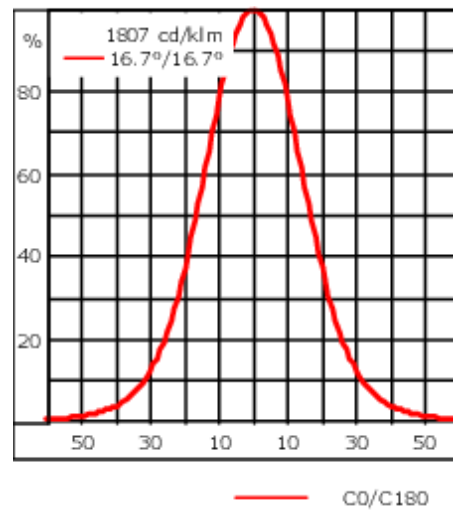

FLC311 Spigot mounted

we-ef



## Specifications

### Material description

Body	Marine-grade, die-cast aluminium alloy
Lens	Safety glass lens
Colours	 RAL9004 Signal black  RAL9007 Grey aluminium  RAL7016 Anthracite grey  RAL9016 Traffic white
Gasket	Silicone CCG® Controlled Compression Gasket
Fasteners	PCS hardware
Ingress protection	IP66
Impact resistance	IK08
Corrosion resistance	5CE
Windage	0.020 m <sup>2</sup>

### Electrical description

Driver / Ballast	DALI interface
Power factor	>0.9

### Additional information

Lifetime	Ta=25° L90B10 > 90000h
----------	------------------------

WE-EF LIGHTING (Thailand) Co., Ltd.

57 Moo 5, Kingkaew Rd., Bangplee, 10540 Samutprakarn - Phone: +66 2 738 96 20 - Fax: +66 2 738 96 29

<https://we-ef.com/asia>

Subject to technical changes and errors. - Generated on 23/11/2024

**FLC311 Spigot mounted**

**Mounting Accessories**

**Flat surface and Column fitter**

Description	Part ID	A	B	Weight (kg)
Column fitter FLC300	145-9536	70		0.20



Flat surface fitter FLC300	145-9535	100	85	0.20
----------------------------	----------	-----	----	------



**FLC311 Spigot mounted**

**Ground spike**

Description	Part ID	A	Weight (kg)
Ground spike EF1 for FLC300	310-9102	270	1.20



**Junction box**

Description	Part ID	A	B	C1	D1	Weight (kg)
Junction box JB1 with side entry	310-9002	107	67	135	67	1.20



**FLC311 Spigot mounted**

Description	Part ID	A	B	C1	D1	Weight (kg)
Junction box JB1 with wall entry	310-9025	107	67	135	67	1.10



Junction box JB1 with side entry (conduit)	310-9022	107	67	135	67	1.20
---	----------	-----	----	-----	----	------

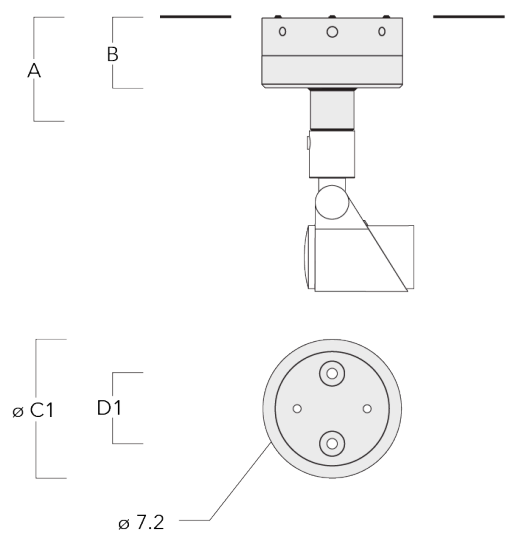

**145-7616**

**FLC311 Spigot mounted**

**we-ef**

## **Control**

### **1-10 V analogue dimming interface**

Description	Part ID
1-10 V analogue dimming interface	430-0011

### **DALI interface**

Description	Part ID
DALI Class II	0043+0013

### **0-10 V, 24VDC low voltage version**

Description	Part ID
24VDC low voltage version, 0-10 V	0033

145-7616

FLC311 Spigot mounted

**we-ef**

## Optical Accessories

### Flood lens

Description	Part ID	C1
Flood lens IO-360 for [EE]	145-7786	59

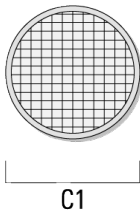

Flood lens IO-360 for [EES]	145-7780	59
-----------------------------	----------	----

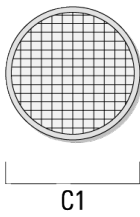

**WE-EF LIGHTING (Thailand) Co., Ltd.**

57 Moo 5, Kingkaew Rd., Bangplee, 10540 Samutprakarn - Phone: +66 2 738 96 20 - Fax: +66 2 738 96 29

<https://we-ef.com/asia>

Subject to technical changes and errors. - Generated on 23/11/2024

145-7616

FLC311 Spigot mounted

**we-ef**

**Linear spread lens**

---

Description	Part ID	C1
Linear spread lens IO-180	145-7781	59

---



---

**Wallwash lens**

---

Description	Part ID	C1
Wallwash lens IO-20	145-7782	59

---

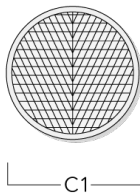

---

**WE-EF LIGHTING (Thailand) Co., Ltd.**

57 Moo 5, Kingkaew Rd., Bangplee, 10540 Samutprakarn - Phone: +66 2 738 96 20 - Fax: +66 2 738 96 29

<https://we-ef.com/asia>

Subject to technical changes and errors. - Generated on 23/11/2024



**FLC311 Spigot mounted**

**Honeycomb louvre**

Description	Part ID	C1	
Honeycomb louvre IW	145-7783	59	



**Glare shield**

Description	Part ID	A	C1
Glare shield ES	145-7784	34	85



145-7616

**we-ef**

FLC311 Spigot mounted

**Snoot**

---

Description	Part ID	A	C1
Snoot ET	145-7785	34	85

---



**WE-EF LIGHTING (Thailand) Co., Ltd.**

57 Moo 5, Kingkaew Rd., Bangplee, 10540 Samutprakarn - Phone: +66 2 738 96 20 - Fax: +66 2 738 96 29

<https://we-ef.com/asia>

Subject to technical changes and errors. - Generated on 23/11/2024