

145-7618

FLC311 Spigot mounted

**we-ef**



#### Description

IP66. IK08. Marine-grade, die-cast aluminium alloy. 5CE superior corrosion protection including PCS hardware. Safety glass lens. Silicone CCG® Controlled Compression Gasket. Luminaire is factory-sealed and does not need to be opened during installation.

Integral EC electronic converter. Advanced thermal management protects LEDs while optimising lumens output. CAD-optimised optics for superior illumination and glare control. Including 1.5 m of flexible PVC free cable.

Mains voltage versions: DALI interface

24VDC low voltage versions: ON-OFF Class III.

Remote 24VDC power supply to be ordered separately.

Weight	1.60 kg
Light distribution	symmetric, very narrow beam [EE]
Light source	LED-3/6W / 180 mA - 2700 K
CRI	80
Power supply	EC
LEDs	3
Rated input power	7.5 W
<b>Nominal Lumen (lm)</b>	
LED Lumen	260
Total Lumen	780
T <sub>j</sub>	85
<b>Rated lumens (lm)</b>	
LED Lumen	201.7
Total Lumen	605.2
T <sub>a</sub>	25

#### WE-EF LIGHTING Pty Ltd

47 Tarnard Drive, 3195 Braeside, Victoria - Phone: +61 3 8587 0444 - Fax: +61 3 8587 0499  
info.australia@we-ef.com - <https://we-ef.com/aus>

Subject to technical changes and errors. - Generated on 19/04/2025

145-7618



FLC311 Spigot mounted

**we-ef**



## Specifications

### Material description

Body	Marine-grade, die-cast aluminium alloy
Lens	Safety glass lens
Colours	 RAL9004 Signal black  RAL9006 White aluminium  RAL9007 Grey aluminium
Gasket	Silicone CCG® Controlled Compression Gasket
Fasteners	PCS hardware
Ingress protection	IP66
Impact resistance	IK08
Corrosion resistance	5CE
Windage	0.020 m <sup>2</sup>

### Electrical description

Driver / Ballast	DALI
Power factor	>0.9

### Additional information

Lifetime	Ta=40° L90B10 > 90000h
----------	------------------------

#### WE-EF LIGHTING Pty Ltd

47 Tarnard Drive, 3195 Braeside, Victoria - Phone: +61 3 8587 0444 - Fax: +61 3 8587 0499

info.australia@we-ef.com - <https://we-ef.com/aus>

Subject to technical changes and errors. - Generated on 19/04/2025

**145-7618**

**FLC311 Spigot mounted**

**we-ef**

## **Control**

### **1-10 V analogue dimming interface**

Description	Part ID	C
1-10 V analogue dimming interface	430-0011	90

### **DALI interface**

Description	Part ID
Low voltage DALI interface	0026

### **0-10 V, 24VDC low voltage version**

Description	Part ID
24VDC low voltage version, 0-10 V	0033

**WE-EF LIGHTING Pty Ltd**

47 Tarnard Drive, 3195 Braeside, Victoria - Phone: +61 3 8587 0444 - Fax: +61 3 8587 0499  
info.australia@we-ef.com - <https://we-ef.com/aus>

Subject to technical changes and errors. - Generated on 19/04/2025

**FLC311 Spigot mounted**

**Mounting Accessories**

**Flat surface and Column fitter**

Description	Part ID	A	B	Weight (kg)
Column fitter FLC300	145-9536	70		0.20

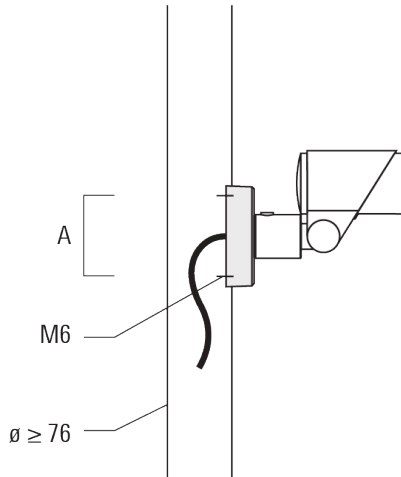

Flat surface fitter FLC300	145-9535	100	85	0.20
----------------------------	----------	-----	----	------

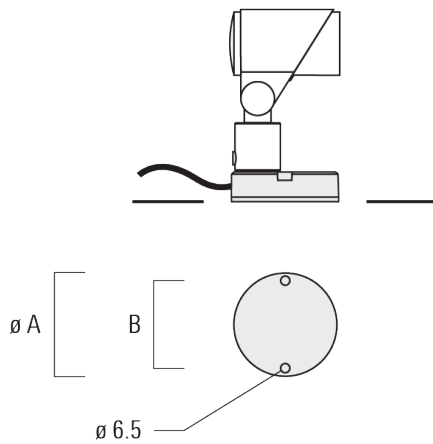

**FLC311 Spigot mounted**

**Ground spike EF**

Description	Part ID	A	Weight (kg)
Ground spike EF1 for FLC300	310-9102	270	1.20



**Junction box JB1**

Description	Part ID	A	B	C1	D1	Weight (kg)
Junction box JB1 with side entry	310-9002	107	67	135	67	1.20



**FLC311 Spigot mounted**

Description	Part ID	A	B	C1	D1	Weight (kg)
Junction box JB1 with wall entry	310-9025	107	67	135	67	1.10

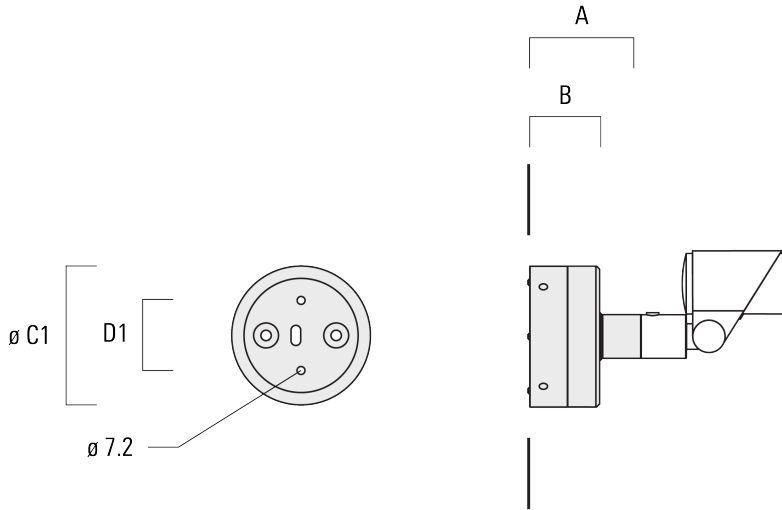

Junction box JB1 with side entry (conduit)	310-9022	107	67	135	67	1.20
-----------------------------------------------	----------	-----	----	-----	----	------



145-7618

FLC311 Spigot mounted

**Optical Accessories**

**Surface wash lens**

---

Description	Part ID	C1
Flood lens IO-360 for [EE]	145-7786	59

---



---

Flood lens IO-360 for [EES]	145-7780	59
-----------------------------	----------	----

---



145-7618

**FLC311 Spigot mounted**

**Linear spread lens**

---

Description	Part ID	C1
Linear spread lens IO-180	145-7781	59

---



---

**Wallwash lens**

---

Description	Part ID	C1
Wallwash lens IO-20	145-7782	59

---



**WE-EF LIGHTING Pty Ltd**

47 Tarnard Drive, 3195 Braeside, Victoria - Phone: +61 3 8587 0444 - Fax: +61 3 8587 0499

info.australia@we-ef.com - <https://we-ef.com/aus>

Subject to technical changes and errors. - Generated on 19/04/2025



**FLC311 Spigot mounted**

**Honeycomb louvre**

---

Description	Part ID	C1
Honeycomb louvre IW	145-7783	59

---

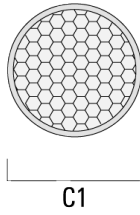

---

**Glare shield**

---

Description	Part ID	A	C1
Glare shield ES	145-7784	34	85

---



145-7618

**we-ef**

FLC311 Spigot mounted

**Snoot**

---

Description	Part ID	A	C1
Snoot ET	145-7785	34	85

---



**WE-EF LIGHTING Pty Ltd**

47 Tarnard Drive, 3195 Braeside, Victoria - Phone: +61 3 8587 0444 - Fax: +61 3 8587 0499

info.australia@we-ef.com - <https://we-ef.com/aus>

Subject to technical changes and errors. - Generated on 19/04/2025