



Description

IP66. IK08. Marine-grade, die-cast aluminium alloy. 5CE superior corrosion protection including PCS hardware. Safety glass lens. Silicone CCG® Controlled Compression Gasket. Luminaire is factory-sealed and does not need to be opened during installation.

Integral EC electronic converter. Advanced thermal management protects LEDs while optimising lumens output. CAD-optimised optics for superior illumination and glare control. Including 1.5 m of flexible PVC free cable. Knuckle permits 340° rotation, forward tilt 54° and backward tilt 90°.

Mains voltage versions, ON-OFF Class I. 1-10 V analogue dimming or DALI interface available on request; refer to accessory listings.

Optical accessories are factory-installed. To be specified at time of ordering.

Weight	2.60 kg
Light distribution	symmetric, wide beam [B]
Light source	LED-6/12W / 700 mA - 2700 K
CRI	80
Power supply	EC
LEDs	6
Rated input power	14.5 W
Nominal Lumen (lm)	
LED Lumen	270
Total Lumen	1620
Tj	85
Rated lumens (lm)	
LED Lumen	148
Total Lumen	887.8
Ta	25

145-9943

FLC321 Spigot mounted

we-ef

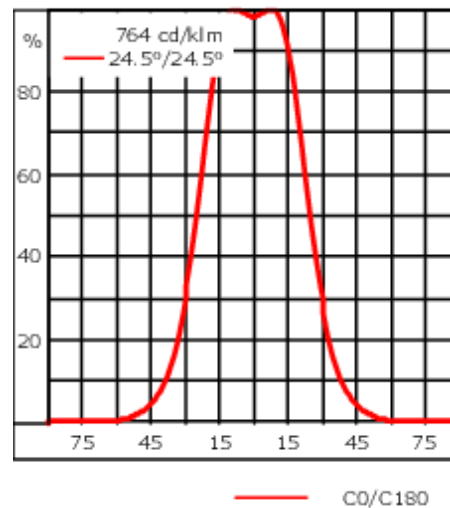
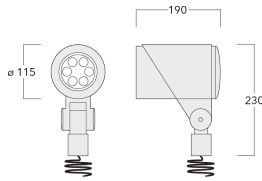

Specifications

Material description

Body	Marine-grade, die-cast aluminium alloy
Lens	Safety glass lens
Colours	 RAL9004 Signal black  RAL9006 White aluminium  RAL9007 Grey aluminium  RAL7016 Anthracite grey  RAL9016 Traffic white
Gasket	Silicone CCG® Controlled Compression Gasket
Fasteners	PCS hardware
Ingress protection	IP66
Impact resistance	IK08
Corrosion resistance	5CE
Windage	0.040 m ²

Electrical description

Driver / Ballast	Integral EC electronic converter
Power factor	>0.9

Additional information

Lifetime	Ta=25° L90B10 > 90000h
Energy efficiency class	C-D (Light source)

WE-EF LEUCHTEN GmbH

Töpinger Straße 16, 29646 Bispingen, Germany - Phone: +49 5194 909-0

info@we-ef.com - <https://we-ef.com>

Subject to technical changes and errors. - Generated on 23/10/2024

145-9943

FLC321 Spigot mounted

we-ef

Control

Eco Step Dim® Advanced

Description	Part ID
Eco Step Dim® Advanced LED	430-0002

0-10 V, 24VDC low voltage version

Description	Part ID
24VDC low voltage version, 0-10 V	0033

WE-EF LEUCHTEN GmbH

Töpinger Straße 16, 29646 Bispingen, Germany - Phone: +49 5194 909-0

info@we-ef.com - <https://we-ef.com>

Subject to technical changes and errors. - Generated on 23/10/2024

FLC321 Spigot mounted

Mounting Accessories

Flat surface and Column fitter

Description	Part ID	A	B	Weight (kg)
Column fitter FLC300	145-9536	70		0.20



Flat surface fitter FLC300	145-9535	100	85	0.20
----------------------------	----------	-----	----	------

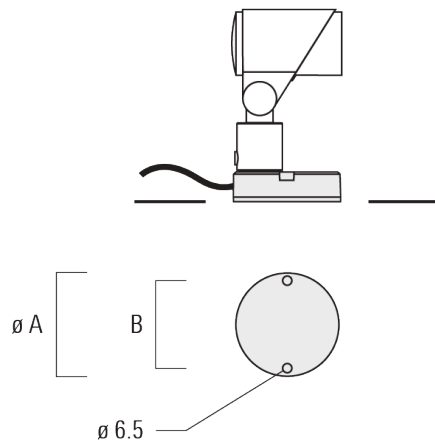

Ground spike EF

WE-EF LEUCHTEN GmbH

Töpinger Straße 16, 29646 Bispingen, Germany - Phone: +49 5194 909-0

info@we-ef.com - <https://we-ef.com>

Subject to technical changes and errors. - Generated on 23/10/2024

FLC321 Spigot mounted

Description	Part ID	A	Weight (kg)
Ground spike EF1 for FLC300	310-9102	270	1.20

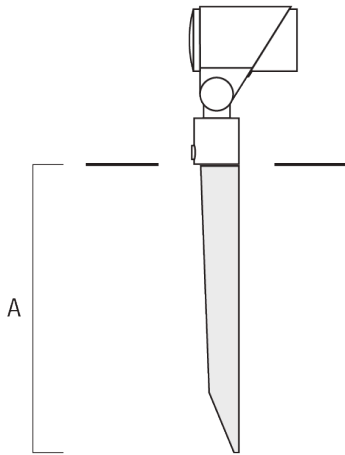

Junction box JB1

Description	Part ID	A	B	C1	D1	Weight (kg)
Junction box JB1 with side entry	310-9002	107	67	135	67	1.20

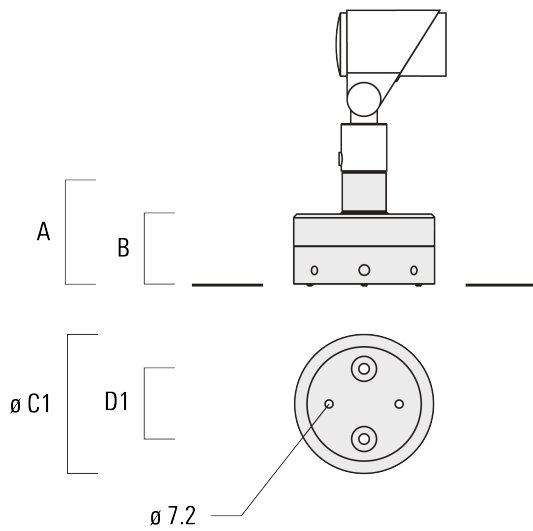

FLC321 Spigot mounted

Description	Part ID	A	B	C1	D1	Weight (kg)
Junction box JB1 with wall entry	310-9025	107	67	135	67	1.10



145-9943

FLC321 Spigot mounted

we-ef

Optical Accessories

Flood lens

Description	Part ID	C1
IO-360-FLC321	145-9992	87



Linear spread lens

Description	Part ID	C1
IO-180-FLC321	145-9991	87



Wallwash lens

WE-EF LEUCHTEN GmbH

Töpinger Straße 16, 29646 Bispingen, Germany - Phone: +49 5194 909-0

info@we-ef.com - <https://we-ef.com>

Subject to technical changes and errors. - Generated on 23/10/2024

145-9943

FLC321 Spigot mounted

Description	Part ID	C1
IO-20-FLC321	145-9993	87



Honeycomb louvre

Description	Part ID	C1
Honeycomb louvre IW	145-9994	87

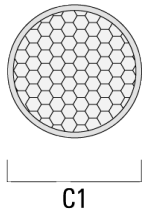

Glare shield

WE-EF LEUCHTEN GmbH

Töpinger Straße 16, 29646 Bispingen, Germany - Phone: +49 5194 909-0

info@we-ef.com - <https://we-ef.com>

Subject to technical changes and errors. - Generated on 23/10/2024

FLC321 Spigot mounted

Description	Part ID	A	C1
ES-FLC321	145-9995	55	114

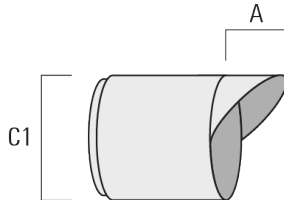

Snoot

Description	Part ID	A	C1
ET-FLC321	145-9996	56	114

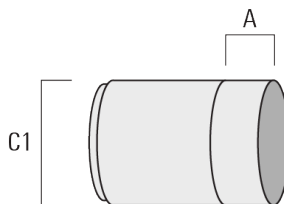

145-9943

FLC321 Spigot mounted

WE-EF LEUCHTEN GmbH

Töpinger Straße 16, 29646 Bispingen, Germany
Phone: +49 5194 909-0

info@we-ef.com
<https://we-ef.com>

Subject to technical changes and errors.
Generated on 23/10/2024