

145-7954

FLC321 Space frame

we-ef



Description

IP66. IK08. Marine-grade, die-cast aluminium alloy. 5CE superior corrosion protection including PCS hardware. Safety glass lens. Silicone CCG® Controlled Compression Gasket. Luminaire is factory-sealed and does not need to be opened during installation.

Integral EC electronic converter in thermally-separated compartment. Advanced thermal management protects LEDs while optimising lumens output. CAD-optimised optics for superior illumination and glare control.

12W, 18W, 26W / 120-277V / 0-10V Dimming.

Including terminal box, for mounting on \varnothing 1.89-2.36 in pipes or space frames.

Optical accessories are factory-installed. To be specified at time of ordering.

Weight	8.00 lb
Light distribution	symmetric, medium beam [M]
Light source	LED-6/12W / 700 mA - 2700 K
CRI	80
Power supply	electronic gear
LEDs	6
Rated input power	14.5 W

Nominal Lumen (lm)

LED Lumen	270
Total Lumen	1620
Tj	85

Rated lumens (lm)

LED Lumen	193.8
Total Lumen	1162.6
Ta	25

WE-EF LIGHTING USA, LLC

410-D Keystone Drive, 15086 Warrendale, PA 15086 - Phone: +1 724 742 0030
customersupport.usa@we-ef.com - <https://we-ef.com/us>
Subject to technical changes and errors. - Generated on 11/23/2024

145-7954

we-ef

FLC321 Space frame

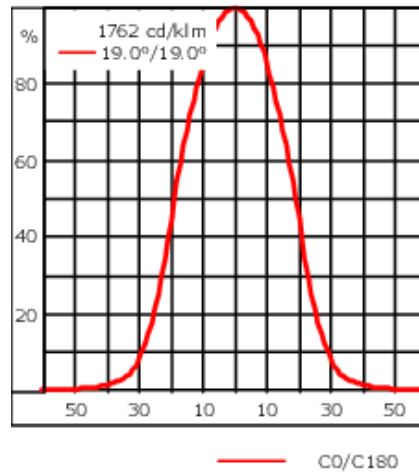
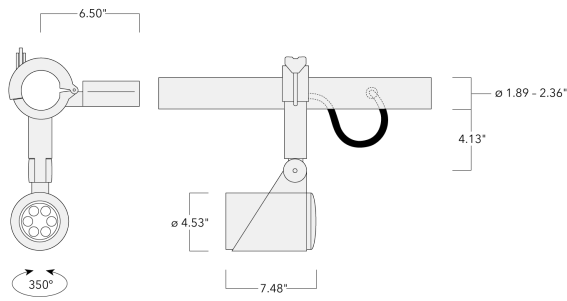

Specifications

Material description

Body	Marine-grade, die-cast aluminium alloy
Lens	Safety glass lens
Colors	<div style="display: flex; align-items: center;"> <div style="width: 20px; height: 15px; background-color: black; margin-right: 5px;"></div> RAL9004 Black </div> <div style="display: flex; align-items: center; margin-top: 5px;"> <div style="width: 20px; height: 15px; background-color: grey; margin-right: 5px;"></div> RAL9007 Grey Metallic </div> <div style="display: flex; align-items: center; margin-top: 5px;"> <div style="width: 20px; height: 15px; background-color: white; border: 1px solid black; margin-right: 5px;"></div> RAL9016 White </div>
Gasket	Silicone CCG® Controlled Compression Gasket
Fasteners	PCS hardware
Ingress protection	IP66
Impact resistance	IK08
Corrosion resistance	5CE
Windage	0.7 ft ²

Electrical description

Driver / Ballast	120-277V AC/50-60 Hz
------------------	----------------------

Additional information

Lifetime	Ta=25°/40° L90B10 > 90000h
Listings	ETL, UL-1598, CSA-C22.2#250.0. Suitable for Wet Locations.

WE-EF LIGHTING USA, LLC

410-D Keystone Drive, 15086 Warrendale, PA 15086 - Phone: +1 724 742 0030
 customersupport.usa@we-ef.com - <https://we-ef.com/us>
 Subject to technical changes and errors. - Generated on 11/23/2024

145-7954

we-ef

FLC321 Space frame

Optical Accessories

Softening Lens

Description	Part ID	C1
Flood lens IO-360	145-9992	3.43

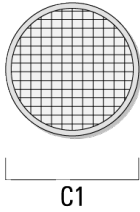

WE-EF LIGHTING USA, LLC

410-D Keystone Drive, 15086 Warrendale, PA 15086 - Phone: +1 724 742 0030
customersupport.usa@we-ef.com - <https://we-ef.com/us>

Subject to technical changes and errors. - Generated on 11/23/2024

145-7954

we-ef

FLC321 Space frame

Linear spread lens

Description	Part ID	C1
Linear spread lens IO-180	145-9991	3.43

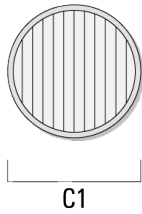

Wallwash lens

Description	Part ID	C1
Wallwash lens IO-20	145-9993	3.43

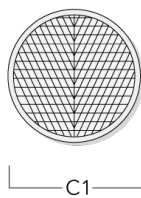

WE-EF LIGHTING USA, LLC

410-D Keystone Drive, 15086 Warrendale, PA 15086 - Phone: +1 724 742 0030
customersupport.usa@we-ef.com - <https://we-ef.com/us>
Subject to technical changes and errors. - Generated on 11/23/2024

FLC321 Space frame

Honeycomb louvre

Description	Part ID	C1
Honeycomb louvre IW	145-9994	3.43

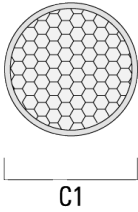

Glare shield

Description	Part ID	A	C1
Glare shield ES	145-9995	2.17	4.49

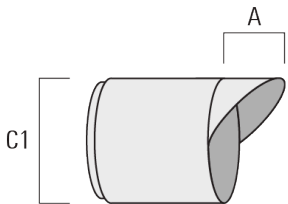

FLC321 Space frame

Snoot

Description	Part ID	A	C1
Snoot ET	145-9996	2.20	4.49

