

145-9966

FLC321 Spigot mounted

**we-ef**



### Description

IP66. IK08. Marine-grade, die-cast aluminium alloy. 5CE superior corrosion protection including PCS hardware. Safety glass lens. Silicone CCG® Controlled Compression Gasket. Luminaire is factory-sealed and does not need to be opened during installation.

Integral EC electronic converter. Advanced thermal management protects LEDs while optimising lumens output. CAD-optimised optics for superior illumination and glare control. Including 1.5 m of flexible PVC free cable. Knuckle permits 340° rotation, forward tilt 54° and backward tilt 90°.

Mains voltage versions, ON-OFF Class I. 1-10 V analogue dimming or DALI interface available on request; refer to accessory listings.

Optical accessories are factory-installed. To be specified at time of ordering.

Weight	2.60 kg
Light distribution	symmetric, very narrow beam, sharp cut-off [EES]
Light source	LED-6/18W / 1050 mA - 4000 K
CRI	80
Power supply	EC
LEDs	6
Rated input power	21 W
<b>Nominal Lumen (lm)</b>	
LED Lumen	430
Total Lumen	2580
Tj	85
<b>Rated lumens (lm)</b>	
LED Lumen	334.4
Total Lumen	2006.2
Ta	25

### Fagerhult Lighting Ltd

33-34 Dolben Street, SE1 0UQ London, United Kingdom

<https://we-ef.com/uk>

Subject to technical changes and errors. - Generated on 23/11/2024

145-9966





FLC321 Spigot mounted

we-ef



## Specifications

### Material description

Body	Marine-grade, die-cast aluminium alloy
Lens	Safety glass lens
Colours	 RAL9004 Signal black  RAL9006 White aluminium  RAL9007 Grey aluminium  RAL7016 Anthracite grey  RAL9016 Traffic white
Gasket	Silicone CCG® Controlled Compression Gasket
Fasteners	PCS hardware
Ingress protection	IP66
Impact resistance	IK08
Corrosion resistance	5CE
Windage	0.040 m <sup>2</sup>

### Electrical description

Driver / Ballast	Integral EC electronic converter
Power factor	>0.9

### Additional information

Lifetime	Ta=25° L90B10 > 90000h
Energy efficiency class	C-D (Light source)

Fagerhult Lighting Ltd

33-34 Dolben Street, SE1 0UQ London, United Kingdom

<https://we-ef.com/uk>

Subject to technical changes and errors. - Generated on 23/11/2024

**145-9966**

**FLC321 Spigot mounted**

**we-ef**

## **Control**

### **Eco Step Dim® Advanced**

Description	Part ID
Eco Step Dim® Advanced LED	430-0002

### **0-10 V, 24VDC low voltage version**

Description	Part ID
24VDC low voltage version, 0-10 V	0033

**Fagerhult Lighting Ltd**

33-34 Dolben Street, SE1 0UQ London, United Kingdom

<https://we-ef.com/uk>

Subject to technical changes and errors. - Generated on 23/11/2024

**FLC321 Spigot mounted**

**Mounting Accessories**

**Flat surface and Column fitter**

Description	Part ID	A	B	Weight (kg)
Column fitter FLC300	145-9536	70		0.20



Flat surface fitter FLC300	145-9535	100	85	0.20
----------------------------	----------	-----	----	------



**FLC321 Spigot mounted**

**Ground spike EF**

Description	Part ID	A	Weight (kg)
Ground spike EF1 for FLC300	310-9102	270	1.20

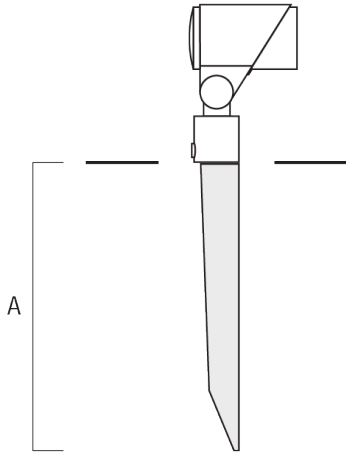

**Junction box JB1**

Description	Part ID	A	B	C1	D1	Weight (kg)
Junction box JB1 with side entry	310-9002	107	67	135	67	1.20

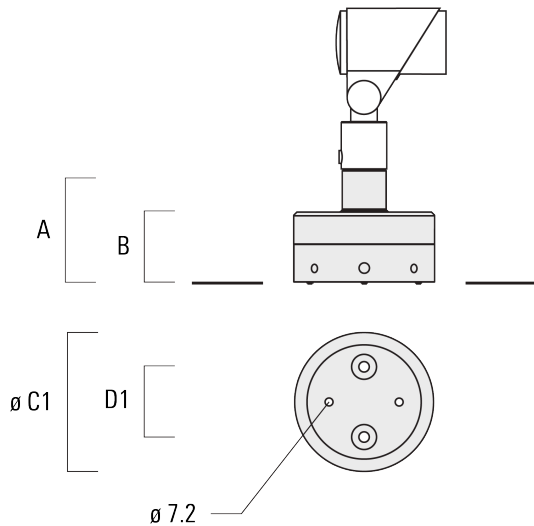

**FLC321 Spigot mounted**

Description	Part ID	A	B	C1	D1	Weight (kg)
Junction box JB1 with wall entry	310-9025	107	67	135	67	1.10



145-9966

FLC321 Spigot mounted

**we-ef**

## Optical Accessories

### Flood lens

Description	Part ID	C1
IO-360-FLC321	145-9992	87



### Linear spread lens

Description	Part ID	C1
IO-180-FLC321	145-9991	87

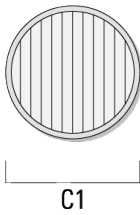

#### Fagerhult Lighting Ltd

33-34 Dolben Street, SE1 0UQ London, United Kingdom

<https://we-ef.com/uk>

Subject to technical changes and errors. - Generated on 23/11/2024

145-9966

**we-ef**

**FLC321 Spigot mounted**

**Wallwash lens**

---

Description	Part ID	C1
IO-20-FLC321	145-9993	87

---



---

**Honeycomb louvre**

---

Description	Part ID	C1
Honeycomb louvre IW	145-9994	87

---



**Fagerhult Lighting Ltd**

33-34 Dolben Street, SE1 0UQ London, United Kingdom

<https://we-ef.com/uk>

Subject to technical changes and errors. - Generated on 23/11/2024



**FLC321 Spigot mounted**

**Glare shield**

Description	Part ID	A	C1
ES-FLC321	145-9995	55	114



**Snoot**

Description	Part ID	A	C1
ET-FLC321	145-9996	56	114

