

145-9986

we-ef

FLC321 Surface mounted



Description

IP66. IK08. Marine-grade, die-cast aluminium alloy. 5CE superior corrosion protection including PCS hardware. Safety glass lens. Silicone CCG® Controlled Compression Gasket. Luminaire is factory-sealed and does not need to be opened during installation.

Integral EC electronic converter. Advanced thermal management protects LEDs while optimising lumens output. CAD-optimised optics for superior illumination and glare control. One cable entry.

Optical accessories are factory-installed. To be specified at time of ordering.

12W, 18W, 26W / 120-277V / 0-10V Dimming.
12W, 18W / 24V DC / 0-10V Dimming. (available upon request)

Contact the factory for 277V or 347V options.

Weight	6.80 lb
Light distribution	symmetric, very narrow beam, 'sharp cut-off' [VNS]
Light source	LED-6/18W / 1050 mA - 2700 K
CRI	80
Power supply	electronic gear
LEDs	6
Rated input power	21 W
Nominal Lumen (lm)	
LED Lumen	375
Total Lumen	2250
Tj	85
Rated lumens (lm)	
LED Lumen	291.6
Total Lumen	1749.6
Ta	25

WE-EF LIGHTING USA, LLC

410-D Keystone Drive, 15086 Warrendale, PA 15086 - Phone: +1 724 742 0030
customersupport.usa@we-ef.com - <https://we-ef.com/us>
Subject to technical changes and errors. - Generated on 11/23/2024

145-9986



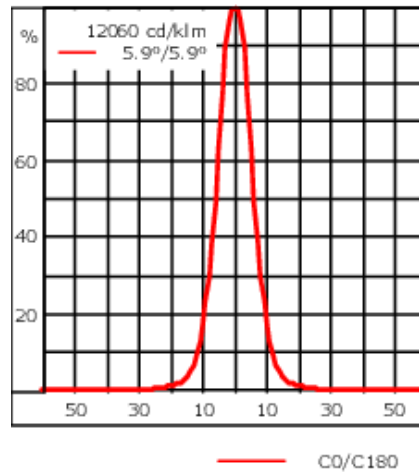
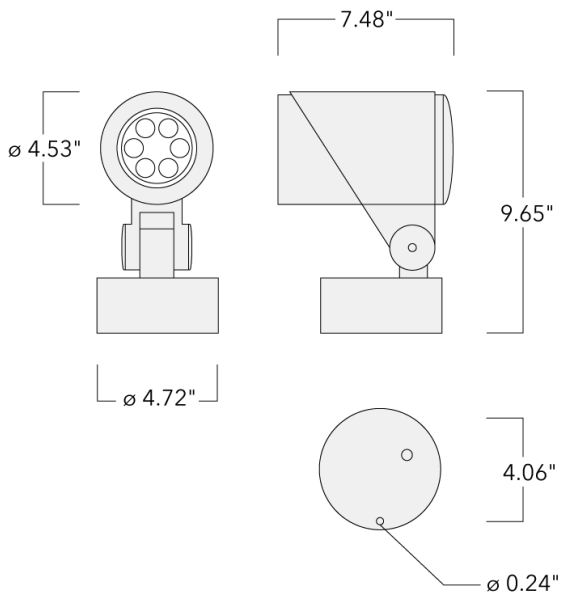

we-ef

FLC321 Surface mounted



Specifications

Material description

Body	Marine-grade, die-cast aluminium alloy
Lens	Safety glass lens
Colors	 RAL9004 Black  RAL9007 Grey Metallic  RAL9016 White  RAL8019 Dark Bronze
Gasket	Silicone CCG® Controlled Compression Gasket
Fasteners	PCS hardware
Ingress protection	IP66
Impact resistance	IK08
Corrosion resistance	5CE
Windage	0.484 ft ²

Electrical description

Power supply	120-277V AC/50-60 Hz (24VDC available upon request)
Driver / Ballast	120-277V AC/50-60 Hz (24VDC available upon request)
Power factor	>0.9

WE-EF LIGHTING USA, LLC

410-D Keystone Drive, 15086 Warrendale, PA 15086 - Phone: +1 724 742 0030

customersupport.usa@we-ef.com - <https://we-ef.com/us>

Subject to technical changes and errors. - Generated on 11/23/2024

145-9986

we-ef

FLC321 Surface mounted

Additional information

Lifetime Ta=25°/40° L90B10 > 90000h

Listings ETL, UL-1598, CSA-C22.2#250.0. Suitable for Wet Locations.

WE-EF LIGHTING USA, LLC

410-D Keystone Drive, 15086 Warrendale, PA 15086 - Phone: +1 724 742 0030
customersupport.usa@we-ef.com - <https://we-ef.com/us>

Subject to technical changes and errors. - Generated on 11/23/2024

Mounting Accessories

Planted root

Description	Part ID	D1	D2	D3	D4	H1	H2	M1	Weight (lb)
Planted root ESV4	300-0461	5.71	5.12	4.01	4.25	15.75	13.78	.31	15.50



FLC321 Surface mounted

Short post EM

Description	Part ID	A	B	C1	D1	Weight (lb)
Short post EM1 for FLC311/321	146-7169	1.02	7.87	4.72	6.30	3.97

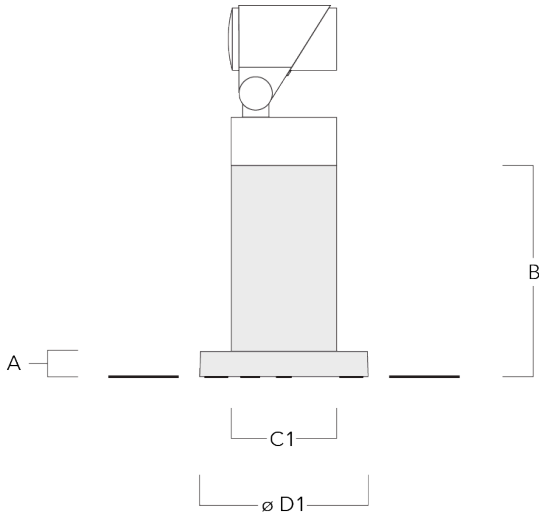

Pole clamp SP

Description	Part ID	D1	Weight (lb)
Pole clamp SP1-M5, single (\varnothing 38-60)	146-7201	38-60	1.20

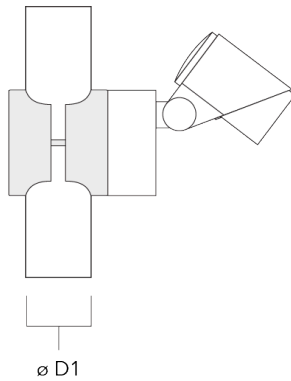

145-9986

we-ef

FLC321 Surface mounted

Description	Part ID	D1	Weight (lb)
Pole clamp SP1-M5, single (Ø 76-89)	146-7202	76-89	1.10

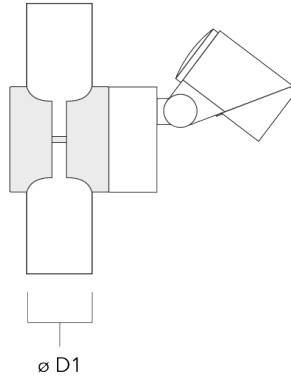

Pole clamp SP2-M5, single (Ø 38-60)	146-7203	38-60	1.30
-------------------------------------	----------	-------	------

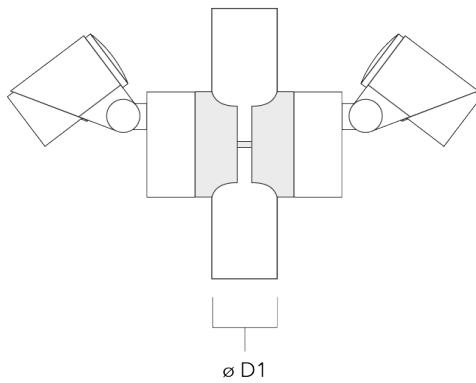

WE-EF LIGHTING USA, LLC

410-D Keystone Drive, 15086 Warrendale, PA 15086 - Phone: +1 724 742 0030
customersupport.usa@we-ef.com - <https://we-ef.com/us>

Subject to technical changes and errors. - Generated on 11/23/2024

145-9986

we-ef

FLC321 Surface mounted

Description	Part ID	D1	Weight (lb)
Pole clamp SP2-M5, single (Ø 76-89)	146-7204	76-89	1.20

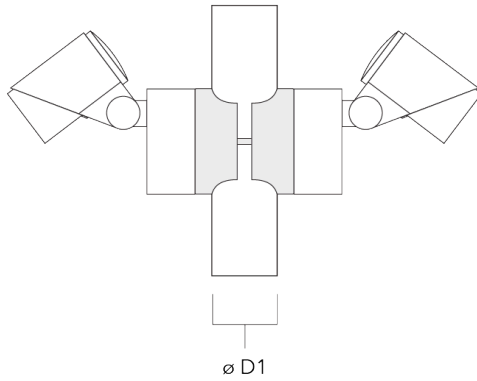

WE-EF LIGHTING USA, LLC

410-D Keystone Drive, 15086 Warrendale, PA 15086 - Phone: +1 724 742 0030
customersupport.usa@we-ef.com - <https://we-ef.com/us>

Subject to technical changes and errors. - Generated on 11/23/2024

145-9986

we-ef

FLC321 Surface mounted

Control

0-10 V, 24VDC low voltage version

Description	Part ID
24VDC low voltage version, 0-10 V	0033

WE-EF LIGHTING USA, LLC

410-D Keystone Drive, 15086 Warrendale, PA 15086 - Phone: +1 724 742 0030
customersupport.usa@we-ef.com - <https://we-ef.com/us>

Subject to technical changes and errors. - Generated on 11/23/2024

145-9986

we-ef

FLC321 Surface mounted

Optical Accessories

Softening Lens

Description	Part ID	C1
Flood lens IO-360	145-9992	3.43

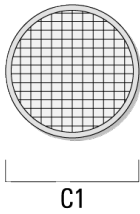

WE-EF LIGHTING USA, LLC

410-D Keystone Drive, 15086 Warrendale, PA 15086 - Phone: +1 724 742 0030
customersupport.usa@we-ef.com - <https://we-ef.com/us>

Subject to technical changes and errors. - Generated on 11/23/2024

145-9986

we-ef

FLC321 Surface mounted

Linear spread lens

Description	Part ID	C1
Linear spread lens IO-180	145-9991	3.43

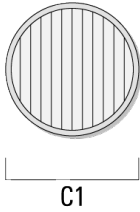

Wallwash lens

Description	Part ID	C1
Wallwash lens IO-20	145-9993	3.43

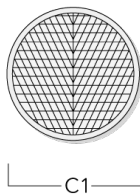

WE-EF LIGHTING USA, LLC

410-D Keystone Drive, 15086 Warrendale, PA 15086 - Phone: +1 724 742 0030
customersupport.usa@we-ef.com - <https://we-ef.com/us>
Subject to technical changes and errors. - Generated on 11/23/2024

145-9986

we-ef

FLC321 Surface mounted

Honeycomb louvre

Description	Part ID	C1
Honeycomb louvre IW	145-9994	3.43



Glare shield

Description	Part ID	A	C1
Glare shield ES	145-9995	2.17	4.49

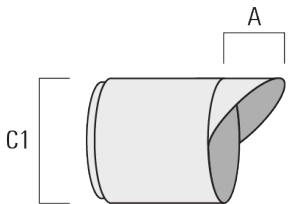

WE-EF LIGHTING USA, LLC

410-D Keystone Drive, 15086 Warrendale, PA 15086 - Phone: +1 724 742 0030
customersupport.usa@we-ef.com - <https://we-ef.com/us>
Subject to technical changes and errors. - Generated on 11/23/2024

145-9986

we-ef

FLC321 Surface mounted

Snoot

Description	Part ID	A	C1
Snoot ET	145-9996	2.20	4.49

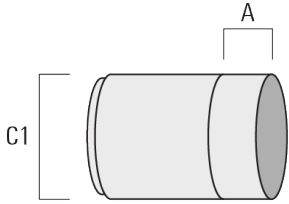

WE-EF LIGHTING USA, LLC

410-D Keystone Drive, 15086 Warrendale, PA 15086 - Phone: +1 724 742 0030
customersupport.usa@we-ef.com - <https://we-ef.com/us>
Subject to technical changes and errors. - Generated on 11/23/2024