

145-7907

FLC321 Wall bracket

**we-ef**



### Description

IP66. IK08. Marine-grade, all aluminium construction. 5CE superior corrosion protection including PCS hardware. Safety glass lens. Silicone CCG® Controlled Compression Gasket. Luminaire is factory-sealed and does not need to be opened during installation.

Integral EC electronic converter. Advanced thermal management protects LEDs while optimising lumens output. CAD-optimised optics for superior illumination and glare control. Two cable entries.

12W, 18W, 26W / 120-277V / 0-10V Dimming.

24VDC low voltage versions, ON-OFF. (available upon request)

Knuckle permits 340° rotation, forward tilt 54° and backward tilt 90°.

Remote 24VDC power supply to be ordered separately.

Optical accessories are factory-installed. To be specified at time of ordering.

Weight	9.00 lb
Light distribution	symmetric, medium beam [M]
Light source	LED-6/18W / 1050 mA - 2700 K
CRI	80
Power supply	electronic gear
LEDs	6
Rated input power	21 W

### Nominal Lumen (lm)

LED Lumen	375
Total Lumen	2250
Tj	85

### Rated lumens (lm)

LED Lumen	269.1
Total Lumen	1614.8
Ta	25

### WE-EF LIGHTING USA, LLC

410-D Keystone Drive, 15086 Warrendale, PA 15086 - Phone: +1 724 742 0030

customersupport.usa@we-ef.com - <https://we-ef.com/us>

Subject to technical changes and errors. - Generated on 11/23/2024

145-7907

**we-ef**

**FLC321 Wall bracket**

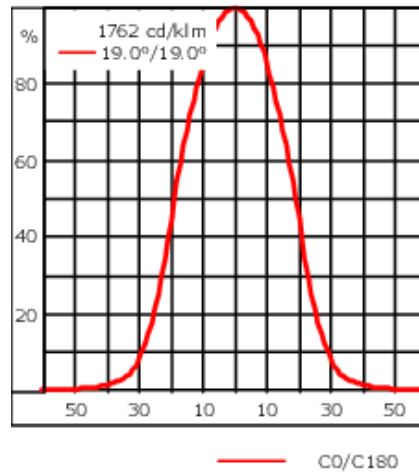
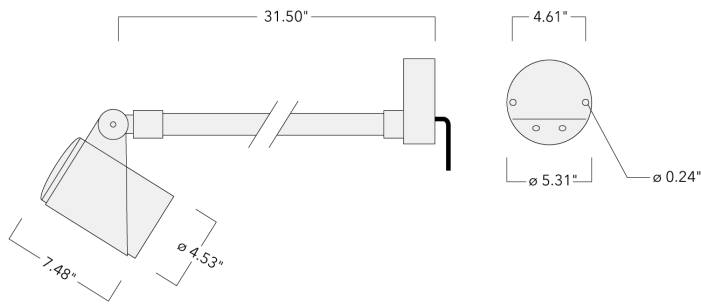

**Specifications**

**Material description**

Body	Marine-grade, all aluminium construction
Lens	Safety glass lens
Colors	<div style="display: flex; flex-direction: column; gap: 5px;"> <div><span style="display: inline-block; width: 15px; height: 15px; background-color: black; margin-right: 5px;"></span> RAL9004 Black</div> <div><span style="display: inline-block; width: 15px; height: 15px; background-color: grey; margin-right: 5px;"></span> RAL9007 Grey Metallic</div> <div><span style="display: inline-block; width: 15px; height: 15px; background-color: white; border: 1px solid black; margin-right: 5px;"></span> RAL9016 White</div> </div>
Gasket	Silicone CCG® Controlled Compression Gasket
Fasteners	PCS hardware
Ingress protection	IP66
Impact resistance	IK08
Corrosion resistance	5CE
Windage	0.969 ft <sup>2</sup>

**Electrical description**

Driver / Ballast	120-277V AC/50-60 Hz (24VDC available upon request)
------------------	---

**Additional information**

Lifetime	Ta=25°/40° L90B10 > 90000h
Listings	ETL, UL-1598, CSA-C22.2#250.0. Suitable for Wet Locations.

**WE-EF LIGHTING USA, LLC**

410-D Keystone Drive, 15086 Warrendale, PA 15086 - Phone: +1 724 742 0030  
customersupport.usa@we-ef.com - <https://we-ef.com/us>  
Subject to technical changes and errors. - Generated on 11/23/2024

**145-7907**

**we-ef**

**FLC321 Wall bracket**

**Control**

**0-10 V, 24VDC low voltage version**

---

Description	Part ID
24VDC low voltage version, 0-10 V	0033

---

**WE-EF LIGHTING USA, LLC**

410-D Keystone Drive, 15086 Warrendale, PA 15086 - Phone: +1 724 742 0030  
customersupport.usa@we-ef.com - <https://we-ef.com/us>

Subject to technical changes and errors. - Generated on 11/23/2024

145-7907

**we-ef**

FLC321 Wall bracket

## Optical Accessories

### Softening Lens

---

Description	Part ID	C1
Flood lens IO-360	145-9992	3.43

---

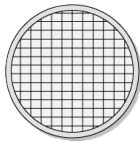

C1

---

#### WE-EF LIGHTING USA, LLC

410-D Keystone Drive, 15086 Warrendale, PA 15086 - Phone: +1 724 742 0030  
customersupport.usa@we-ef.com - <https://we-ef.com/us>

Subject to technical changes and errors. - Generated on 11/23/2024

145-7907

**we-ef**

**FLC321 Wall bracket**

**Linear spread lens**

---

Description	Part ID	C1
Linear spread lens IO-180	145-9991	3.43

---

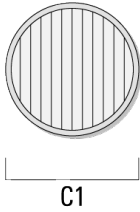

---

**Wallwash lens**

---

Description	Part ID	C1
Wallwash lens IO-20	145-9993	3.43

---

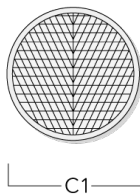

---

**WE-EF LIGHTING USA, LLC**

410-D Keystone Drive, 15086 Warrendale, PA 15086 - Phone: +1 724 742 0030  
customersupport.usa@we-ef.com - <https://we-ef.com/us>  
Subject to technical changes and errors. - Generated on 11/23/2024

145-7907

**we-ef**

**FLC321 Wall bracket**

**Honeycomb louvre**

---

Description	Part ID	C1
Honeycomb louvre IW	145-9994	3.43

---

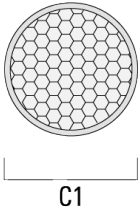

---

**Glare shield**

---

Description	Part ID	A	C1
Glare shield ES	145-9995	2.17	4.49

---

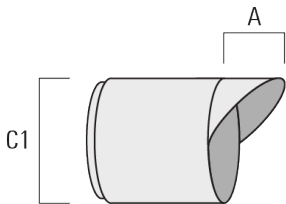

---

**WE-EF LIGHTING USA, LLC**

410-D Keystone Drive, 15086 Warrendale, PA 15086 - Phone: +1 724 742 0030  
customersupport.usa@we-ef.com - <https://we-ef.com/us>  
Subject to technical changes and errors. - Generated on 11/23/2024

**FLC321 Wall bracket**

**Snoot**

---

Description	Part ID	A	C1
Snoot ET	145-9996	2.20	4.49

---

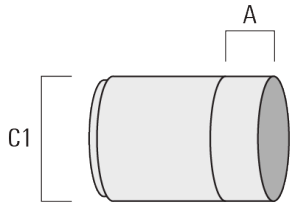

**WE-EF LIGHTING USA, LLC**

410-D Keystone Drive, 15086 Warrendale, PA 15086 - Phone: +1 724 742 0030  
customersupport.usa@we-ef.com - <https://we-ef.com/us>  
Subject to technical changes and errors. - Generated on 11/23/2024