

145-7909

FLC321 Wall bracket

we-ef



Description

IP66. IK08. Marine-grade, all aluminium construction. 5CE superior corrosion protection including PCS hardware. Safety glass lens. Silicone CCG® Controlled Compression Gasket. Luminaire is factory-sealed and does not need to be opened during installation.

Integral EC electronic converter. Advanced thermal management protects LEDs while optimising lumens output. CAD-optimised optics for superior illumination and glare control. Two cable entries.

12W, 18W, 26W / 120-277V / 0-10V Dimming.

24VDC low voltage versions, ON-OFF. (available upon request)

Knuckle permits 340° rotation, forward tilt 54° and backward tilt 90°.

Remote 24VDC power supply to be ordered separately.

Optical accessories are factory-installed. To be specified at time of ordering.

| | |
|--------------------|------------------------------|
| Weight | 9.00 lb |
| Light distribution | symmetric, medium beam [M] |
| Light source | LED-6/18W / 1050 mA - 3000 K |
| CRI | 80 |
| Power supply | electronic gear |
| LEDs | 6 |
| Rated input power | 21 W |

Nominal Lumen (lm)

| | |
|-------------|------|
| LED Lumen | 405 |
| Total Lumen | 2430 |
| Tj | 85 |

Rated lumens (lm)

| | |
|-------------|--------|
| LED Lumen | 290.7 |
| Total Lumen | 1743.9 |
| Ta | 25 |

WE-EF LIGHTING USA, LLC

410-D Keystone Drive, 15086 Warrendale, PA 15086 - Phone: +1 724 742 0030

customersupport.usa@we-ef.com - <https://we-ef.com/us>

Subject to technical changes and errors. - Generated on 11/23/2024

145-7909

we-ef

FLC321 Wall bracket

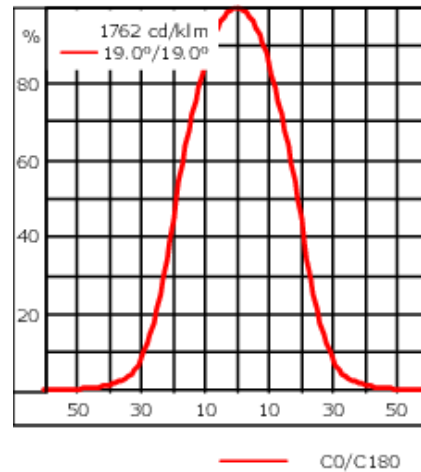
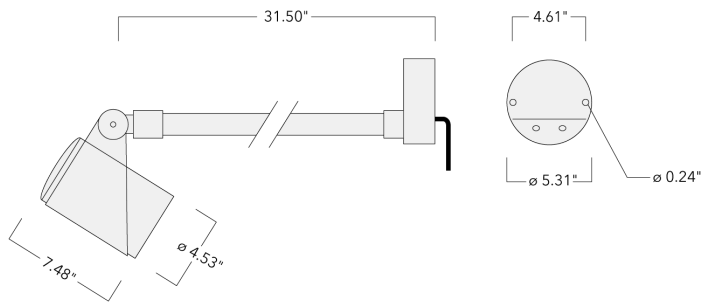

Specifications

Material description

| | |
|----------------------|---|
| Body | Marine-grade, all aluminium construction |
| Lens | Safety glass lens |
| Colors | <div style="display: flex; flex-direction: column; gap: 5px;"> <div> RAL9004 Black</div> <div> RAL9007 Grey Metallic</div> <div> RAL9016 White</div> </div> |
| Gasket | Silicone CCG® Controlled Compression Gasket |
| Fasteners | PCS hardware |
| Ingress protection | IP66 |
| Impact resistance | IK08 |
| Corrosion resistance | 5CE |
| Windage | 0.969 ft ² |

Electrical description

| | |
|------------------|---|
| Driver / Ballast | 120-277V AC/50-60 Hz (24VDC available upon request) |
|------------------|---|

Additional information

| | |
|----------|--|
| Lifetime | Ta=25°/40° L90B10 > 90000h |
| Listings | ETL, UL-1598, CSA-C22.2#250.0. Suitable for Wet Locations. |

WE-EF LIGHTING USA, LLC

410-D Keystone Drive, 15086 Warrendale, PA 15086 - Phone: +1 724 742 0030
 customersupport.usa@we-ef.com - <https://we-ef.com/us>
 Subject to technical changes and errors. - Generated on 11/23/2024

145-7909

we-ef

FLC321 Wall bracket

Control

0-10 V, 24VDC low voltage version

| Description | Part ID |
|-----------------------------------|---------|
| 24VDC low voltage version, 0-10 V | 0033 |

WE-EF LIGHTING USA, LLC

410-D Keystone Drive, 15086 Warrendale, PA 15086 - Phone: +1 724 742 0030
customersupport.usa@we-ef.com - <https://we-ef.com/us>

Subject to technical changes and errors. - Generated on 11/23/2024

145-7909

we-ef

FLC321 Wall bracket

Optical Accessories

Softening Lens

| Description | Part ID | C1 |
|-------------------|----------|------|
| Flood lens IO-360 | 145-9992 | 3.43 |

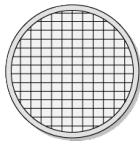

C1

WE-EF LIGHTING USA, LLC

410-D Keystone Drive, 15086 Warrendale, PA 15086 - Phone: +1 724 742 0030
customersupport.usa@we-ef.com - <https://we-ef.com/us>

Subject to technical changes and errors. - Generated on 11/23/2024

145-7909

we-ef

FLC321 Wall bracket

Linear spread lens

| Description | Part ID | C1 |
|---------------------------|----------|------|
| Linear spread lens IO-180 | 145-9991 | 3.43 |

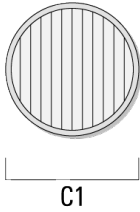

Wallwash lens

| Description | Part ID | C1 |
|---------------------|----------|------|
| Wallwash lens IO-20 | 145-9993 | 3.43 |

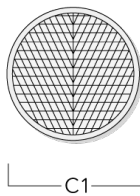

WE-EF LIGHTING USA, LLC

410-D Keystone Drive, 15086 Warrendale, PA 15086 - Phone: +1 724 742 0030
customersupport.usa@we-ef.com - <https://we-ef.com/us>
Subject to technical changes and errors. - Generated on 11/23/2024

145-7909

we-ef

FLC321 Wall bracket

Honeycomb louvre

| Description | Part ID | C1 |
|---------------------|----------|------|
| Honeycomb louvre IW | 145-9994 | 3.43 |

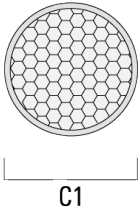

Glare shield

| Description | Part ID | A | C1 |
|-----------------|----------|------|------|
| Glare shield ES | 145-9995 | 2.17 | 4.49 |

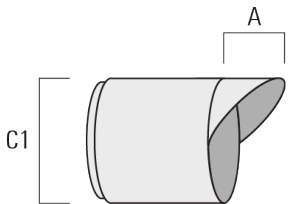

WE-EF LIGHTING USA, LLC

410-D Keystone Drive, 15086 Warrendale, PA 15086 - Phone: +1 724 742 0030
customersupport.usa@we-ef.com - <https://we-ef.com/us>
Subject to technical changes and errors. - Generated on 11/23/2024

145-7909

we-ef

FLC321 Wall bracket

Snoot

| Description | Part ID | A | C1 |
|-------------|----------|------|------|
| Snoot ET | 145-9996 | 2.20 | 4.49 |

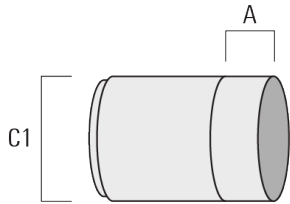

WE-EF LIGHTING USA, LLC

410-D Keystone Drive, 15086 Warrendale, PA 15086 - Phone: +1 724 742 0030
customersupport.usa@we-ef.com - <https://we-ef.com/us>

Subject to technical changes and errors. - Generated on 11/23/2024