

145-7965

FLC321 Space frame

we-ef

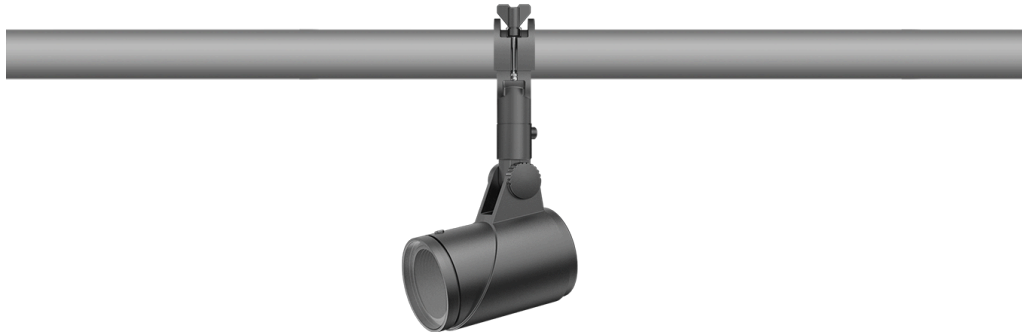

Description

IP66. IK08. Marine-grade, die-cast aluminium alloy. 5CE superior corrosion protection including PCS hardware. Safety glass lens. Silicone CCG® Controlled Compression Gasket. Luminaire is factory-sealed and does not need to be opened during installation.

Integral EC electronic converter in thermally-separated compartment. Advanced thermal management protects LEDs while optimising lumens output. CAD-optimised optics for superior illumination and glare control.

12W, 18W, 26W / 120-277V / 0-10V Dimming.

Including terminal box, for mounting on \varnothing 1.89-2.36 in pipes or space frames.

Optical accessories are factory-installed. To be specified at time of ordering.

Weight	8.00 lb
Light distribution	symmetric, very narrow beam [VN]
Light source	LED-6/18W / 1050 mA - 4000 K
CRI	80
Power supply	electronic gear
LEDs	6
Rated input power	21 W
Nominal Lumen (lm)	
LED Lumen	430
Total Lumen	2580
Tj	85
Rated lumens (lm)	
LED Lumen	325.1
Total Lumen	1950.5
Ta	25

WE-EF LIGHTING USA, LLC

410-D Keystone Drive, 15086 Warrendale, PA 15086 - Phone: +1 724 742 0030

customersupport.usa@we-ef.com - <https://we-ef.com/us>

Subject to technical changes and errors. - Generated on 10/23/2024

145-7965

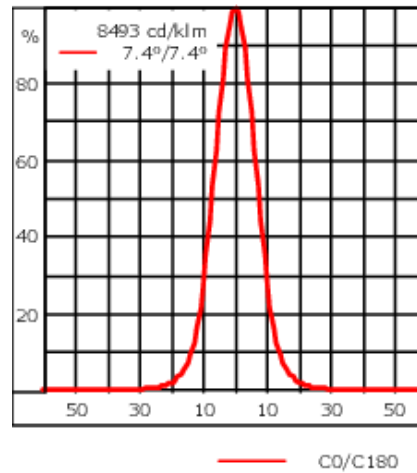
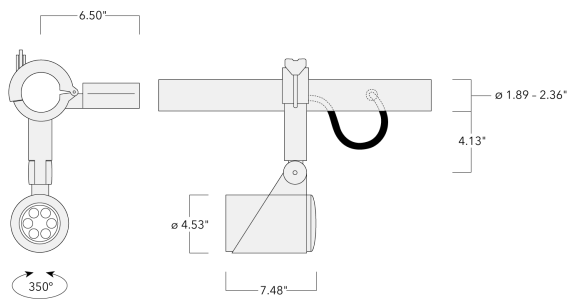

we-ef

FLC321 Space frame



Specifications

Material description

Body	Marine-grade, die-cast aluminium alloy
Lens	Safety glass lens
Colors	 RAL9004 Black  RAL9007 Grey Metallic  RAL9016 White
Gasket	Silicone CCG® Controlled Compression Gasket
Fasteners	PCS hardware
Ingress protection	IP66
Impact resistance	IK08
Corrosion resistance	5CE
Windage	0.7 ft ²

Electrical description

Driver / Ballast	120-277V AC/50-60 Hz
------------------	----------------------

Additional information

Lifetime	Ta=25°/40° L90B10 > 90000h
Listings	ETL, UL-1598, CSA-C22.2#250.0. Suitable for Wet Locations.

WE-EF LIGHTING USA, LLC

410-D Keystone Drive, 15086 Warrendale, PA 15086 - Phone: +1 724 742 0030
customersupport.usa@we-ef.com - <https://we-ef.com/us>
Subject to technical changes and errors. - Generated on 10/23/2024

145-7965

we-ef

FLC321 Space frame

Optical Accessories

Softening Lens

Description	Part ID	C1
Flood lens IO-360	145-9992	3.43

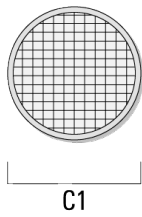

Linear spread lens

WE-EF LIGHTING USA, LLC

410-D Keystone Drive, 15086 Warrendale, PA 15086 - Phone: +1 724 742 0030

customersupport.usa@we-ef.com - <https://we-ef.com/us>

Subject to technical changes and errors. - Generated on 10/23/2024

FLC321 Space frame

Description	Part ID	C1
Linear spread lens IO-180	145-9991	3.43

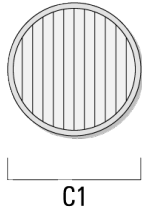

Wallwash lens

Description	Part ID	C1
Wallwash lens IO-20	145-9993	3.43

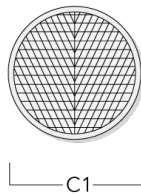

Honeycomb louvre

WE-EF LIGHTING USA, LLC

410-D Keystone Drive, 15086 Warrendale, PA 15086 - Phone: +1 724 742 0030

customersupport.usa@we-ef.com - <https://we-ef.com/us>

Subject to technical changes and errors. - Generated on 10/23/2024

FLC321 Space frame

Description	Part ID	C1
Honeycomb louvre IW	145-9994	3.43

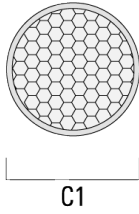

Glare shield

Description	Part ID	A	C1
Glare shield ES	145-9995	2.17	4.49

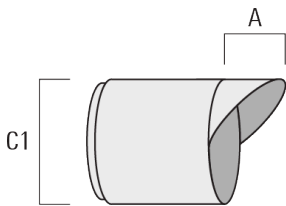

Snoot

WE-EF LIGHTING USA, LLC

410-D Keystone Drive, 15086 Warrendale, PA 15086 - Phone: +1 724 742 0030

customersupport.usa@we-ef.com - <https://we-ef.com/us>

Subject to technical changes and errors. - Generated on 10/23/2024

145-7965

we-ef

FLC321 Space frame

Description	Part ID	A	C1
Snoot ET	145-9996	2.20	4.49

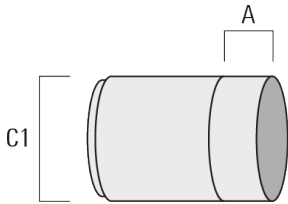

WE-EF LIGHTING USA, LLC

410-D Keystone Drive, 15086 Warrendale, PA 15086 - Phone: +1 724 742 0030

customersupport.usa@we-ef.com - <https://we-ef.com/us>

Subject to technical changes and errors. - Generated on 10/23/2024

145-7965

FLC321 Space frame

WE-EF LIGHTING USA, LLC

410-D Keystone Drive, 15086 Warrendale, PA 15086

Phone: +1 724 742 0030

customersupport.usa@we-ef.com

<https://we-ef.com/us>

Subject to technical changes and errors.

Generated on 10/23/2024

we-ef

A Fagerhult Group Company