

145-7971

FLC321 Space frame

we-ef



Description

IP66. IK08. Marine-grade, die-cast aluminium alloy. 5CE superior corrosion protection including PCS hardware. Safety glass lens. Silicone CCG® Controlled Compression Gasket. Luminaire is factory-sealed and does not need to be opened during installation.

Integral EC electronic converter in thermally-separated compartment. Advanced thermal management protects LEDs while optimising lumens output. CAD-optimised optics for superior illumination and glare control.

12W, 18W, 26W / 120-277V / 0-10V Dimming.

Including terminal box, for mounting on \varnothing 1.89-2.36 in pipes or space frames.

Optical accessories are factory-installed. To be specified at time of ordering.

| | |
|---------------------------|--|
| Weight | 8.00 lb |
| Light distribution | symmetric, very narrow beam, 'sharp cut-off' [VNS] |
| Light source | LED-6/18W / 1050 mA - 4000 K |
| CRI | 80 |
| Power supply | electronic gear |
| LEDs | 6 |
| Rated input power | 21 W |
| Nominal Lumen (lm) | |
| LED Lumen | 430 |
| Total Lumen | 2580 |
| Tj | 85 |
| Rated lumens (lm) | |
| LED Lumen | 334.4 |
| Total Lumen | 2006.2 |
| Ta | 25 |

WE-EF LIGHTING USA, LLC

410-D Keystone Drive, 15086 Warrendale, PA 15086 - Phone: +1 724 742 0030

customersupport.usa@we-ef.com - <https://we-ef.com/us>

Subject to technical changes and errors. - Generated on 10/23/2024

145-7971

we-ef

FLC321 Space frame

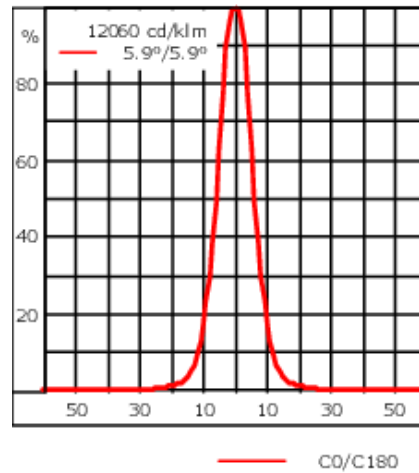
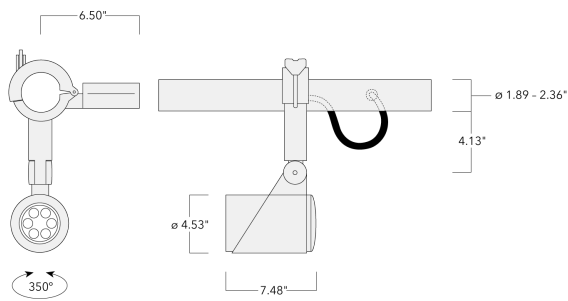

Specifications

Material description

| | |
|----------------------|--|
| Body | Marine-grade, die-cast aluminium alloy |
| Lens | Safety glass lens |
| Colors | <div style="display: flex; align-items: center;"> <div style="width: 20px; height: 10px; background-color: black; margin-right: 5px;"></div> RAL9004 Black </div> <div style="display: flex; align-items: center; margin-top: 5px;"> <div style="width: 20px; height: 10px; background-color: grey; margin-right: 5px;"></div> RAL9007 Grey Metallic </div> <div style="display: flex; align-items: center; margin-top: 5px;"> <div style="width: 20px; height: 10px; background-color: white; border: 1px solid black; margin-right: 5px;"></div> RAL9016 White </div> |
| Gasket | Silicone CCG® Controlled Compression Gasket |
| Fasteners | PCS hardware |
| Ingress protection | IP66 |
| Impact resistance | IK08 |
| Corrosion resistance | 5CE |
| Windage | 0.7 ft ² |

Electrical description

| | |
|------------------|----------------------|
| Driver / Ballast | 120-277V AC/50-60 Hz |
|------------------|----------------------|

Additional information

| | |
|----------|--|
| Lifetime | Ta=25°/40° L90B10 > 90000h |
| Listings | ETL, UL-1598, CSA-C22.2#250.0. Suitable for Wet Locations. |

WE-EF LIGHTING USA, LLC

410-D Keystone Drive, 15086 Warrendale, PA 15086 - Phone: +1 724 742 0030

customersupport.usa@we-ef.com - <https://we-ef.com/us>

Subject to technical changes and errors. - Generated on 10/23/2024

145-7971

we-ef

FLC321 Space frame

Optical Accessories

Softening Lens

| Description | Part ID | C1 |
|-------------------|----------|------|
| Flood lens IO-360 | 145-9992 | 3.43 |

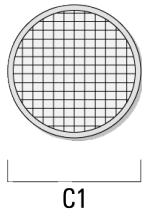

Linear spread lens

WE-EF LIGHTING USA, LLC

410-D Keystone Drive, 15086 Warrendale, PA 15086 - Phone: +1 724 742 0030

customersupport.usa@we-ef.com - <https://we-ef.com/us>

Subject to technical changes and errors. - Generated on 10/23/2024

145-7971

we-ef

FLC321 Space frame

| Description | Part ID | C1 |
|---------------------------|----------|------|
| Linear spread lens IO-180 | 145-9991 | 3.43 |

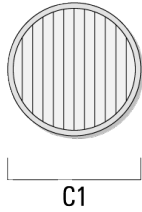

Wallwash lens

| Description | Part ID | C1 |
|---------------------|----------|------|
| Wallwash lens IO-20 | 145-9993 | 3.43 |

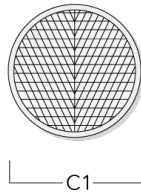

Honeycomb louvre

WE-EF LIGHTING USA, LLC

410-D Keystone Drive, 15086 Warrendale, PA 15086 - Phone: +1 724 742 0030

customersupport.usa@we-ef.com - <https://we-ef.com/us>

Subject to technical changes and errors. - Generated on 10/23/2024

FLC321 Space frame

| Description | Part ID | C1 |
|---------------------|----------|------|
| Honeycomb louvre IW | 145-9994 | 3.43 |

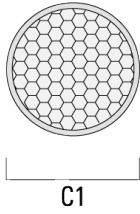

Glare shield

| Description | Part ID | A | C1 |
|-----------------|----------|------|------|
| Glare shield ES | 145-9995 | 2.17 | 4.49 |

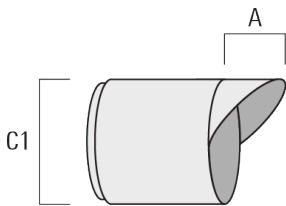

Snoot

WE-EF LIGHTING USA, LLC

410-D Keystone Drive, 15086 Warrendale, PA 15086 - Phone: +1 724 742 0030

customersupport.usa@we-ef.com - <https://we-ef.com/us>

Subject to technical changes and errors. - Generated on 10/23/2024

145-7971

we-ef

FLC321 Space frame

| Description | Part ID | A | C1 |
|-------------|----------|------|------|
| Snoot ET | 145-9996 | 2.20 | 4.49 |

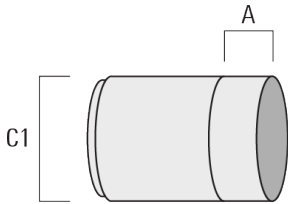

WE-EF LIGHTING USA, LLC

410-D Keystone Drive, 15086 Warrendale, PA 15086 - Phone: +1 724 742 0030

customersupport.usa@we-ef.com - <https://we-ef.com/us>

Subject to technical changes and errors. - Generated on 10/23/2024

145-7971

FLC321 Space frame

WE-EF LIGHTING USA, LLC

410-D Keystone Drive, 15086 Warrendale, PA 15086

Phone: +1 724 742 0030

customersupport.usa@we-ef.com

<https://we-ef.com/us>

Subject to technical changes and errors.

Generated on 10/23/2024

we-ef

A Fagerhult Group Company