

145-7652

we-ef

FLC311 Surface mounted



Description

IP66. IK08. Marine-grade, die-cast aluminium alloy. 5CE superior corrosion protection including PCS hardware. Safety glass lens. Silicone CCG® Controlled Compression Gasket. Luminaire is factory-sealed and does not need to be opened during installation.

Integral EC electronic converter. Advanced thermal management protects LEDs while optimising lumens output. CAD-optimised optics for superior illumination and glare control. One cable entry.

Optical accessories are factory-installed. To be specified at time of ordering.

6-12W / 120V / 0-10V Dimming.
6W / 24V DC / 0-10V Dimming. (available upon request)

Contact the factory for 277V or 347V options.

Weight	2.20 lb
Light distribution	symmetric, medium beam [M]
Light source	LED-3/9W / 250 mA - 4000 K
CRI	80
Power supply	electronic gear
LEDs	3
Rated input power	11 W
Nominal Lumen (lm)	
LED Lumen	390
Total Lumen	1170
Tj	85
Delivered lumens (lm)	
LED Lumen	300.2
Total Lumen	900.6
Ta	25

WE-EF LIGHTING USA, LLC

410-D Keystone Drive, 15086 Warrendale, PA 15086 - Phone: +1 724 742 0030
customersupport.usa@we-ef.com - <https://we-ef.com/us>
Subject to technical changes and errors. - Generated on 06/08/2025

145-7652

we-ef

FLC311 Surface mounted

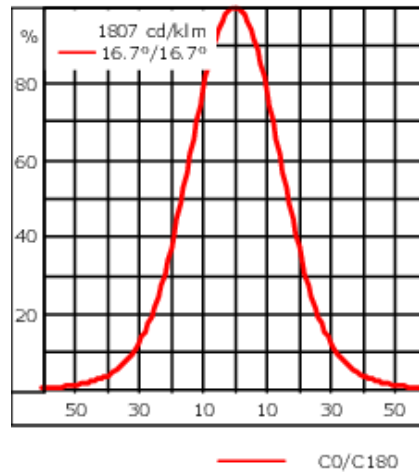
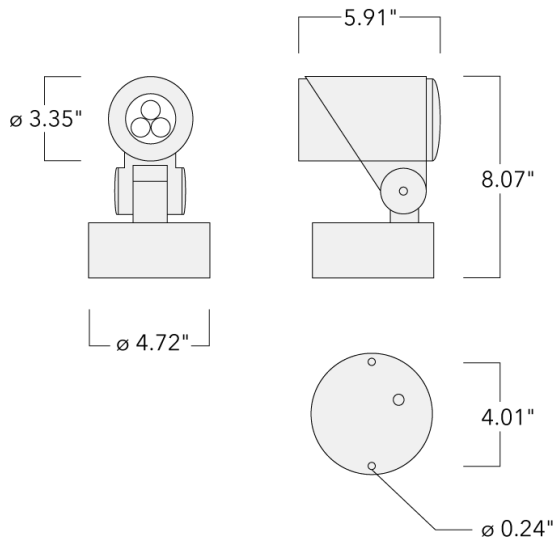

Specifications

Material description

Body	Marine-grade, die-cast aluminium alloy
Lens	Safety glass lens
Colors	<div style="display: flex; flex-direction: column; gap: 5px;"> <div> RAL9004 Black</div> <div> RAL9007 Grey Metallic</div> <div> RAL9016 White</div> <div> RAL8019 Dark Bronze</div> </div>
Gasket	Silicone CCG® Controlled Compression Gasket
Fasteners	PCS hardware
Ingress protection	IP66
Impact resistance	IK08
Corrosion resistance	5CE
Windage	0.269 ft ²

Electrical description

Power supply	120-277VAC/50-60 Hz (24V DC available upon request)
Driver / Ballast	Integral [ECG] electronic driver 120V-277V. (24VDC low voltage, available upon request)
Power factor	>0.9

WE-EF LIGHTING USA, LLC

410-D Keystone Drive, 15086 Warrendale, PA 15086 - Phone: +1 724 742 0030

customersupport.usa@we-ef.com - <https://we-ef.com/us>

Subject to technical changes and errors. - Generated on 06/08/2025

145-7652

we-ef

FLC311 Surface mounted

Additional information

Lifetime	Ta=25°/40° L90B10 > 90000h
Dimming	0-10V Dimming as standard
Listings	ETL, UL-1598, CSA-C22.2#250.0. Suitable for Wet Locations.

WE-EF LIGHTING USA, LLC

410-D Keystone Drive, 15086 Warrendale, PA 15086 - Phone: +1 724 742 0030
customersupport.usa@we-ef.com - <https://we-ef.com/us>
Subject to technical changes and errors. - Generated on 06/08/2025

145-7652

we-ef

FLC311 Surface mounted

Mounting Accessories

Planted root

Description	Part ID	D1	D2	D3	D4	H1	H2	M1	Weight (lb)
Planted root ESV4	300-0461	5.71	5.12	4.01	4.25	15.75	13.78	.31	15.50

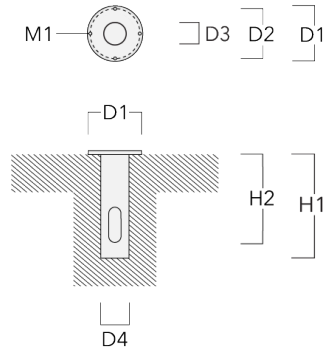

WE-EF LIGHTING USA, LLC

410-D Keystone Drive, 15086 Warrendale, PA 15086 - Phone: +1 724 742 0030
customersupport.usa@we-ef.com - <https://we-ef.com/us>

Subject to technical changes and errors. - Generated on 06/08/2025

FLC311 Surface mounted

Short post EM

Description	Part ID	A	B	C1	D1	Weight (lb)
Short post EM1 for FLC311/321	146-7169	1.02	7.87	4.72	6.30	3.97

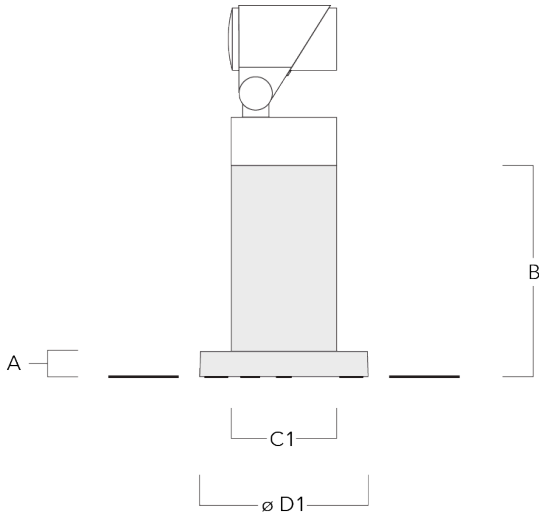

Pole clamp SP

Description	Part ID	D1	Weight (lb)
Pole clamp SP1-M5, single (\varnothing 38-60)	146-7201	38-60	1.20

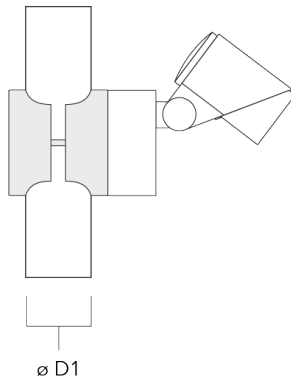

FLC311 Surface mounted

Description	Part ID	D1	Weight (lb)
Pole clamp SP1-M5, single (Ø 76-89)	146-7202	76-89	1.10

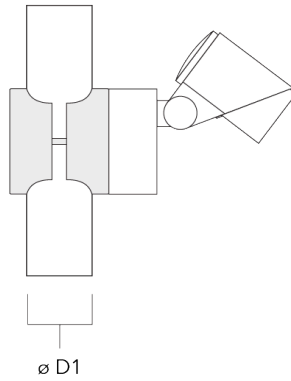

Pole clamp SP2-M5, double (Ø 38-60)	146-7203	38-60	1.30
-------------------------------------	----------	-------	------

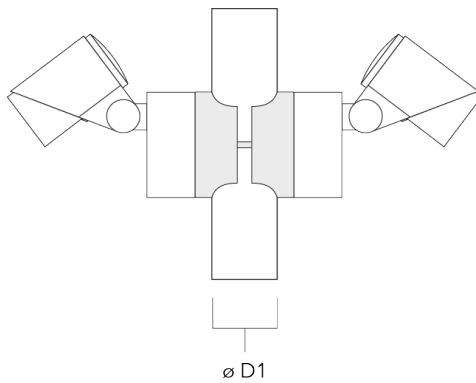

WE-EF LIGHTING USA, LLC

410-D Keystone Drive, 15086 Warrendale, PA 15086 - Phone: +1 724 742 0030
 customersupport.usa@we-ef.com - <https://we-ef.com/us>
 Subject to technical changes and errors. - Generated on 06/08/2025

145-7652

we-ef

FLC311 Surface mounted

Description	Part ID	D1	Weight (lb)
Pole clamp SP2-M5, double (Ø 76-89)	146-7204	76-89	1.20

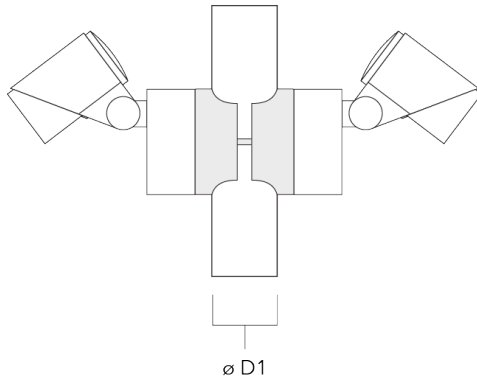

WE-EF LIGHTING USA, LLC

410-D Keystone Drive, 15086 Warrendale, PA 15086 - Phone: +1 724 742 0030
customersupport.usa@we-ef.com - <https://we-ef.com/us>

Subject to technical changes and errors. - Generated on 06/08/2025

145-7652

we-ef

FLC311 Surface mounted

Control

DALI interface

Description	Part ID
Low voltage DALI interface	0026

0-10 V, 24VDC low voltage version

Description	Part ID
24VDC low voltage version, 0-10 V	0033

WE-EF LIGHTING USA, LLC

410-D Keystone Drive, 15086 Warrendale, PA 15086 - Phone: +1 724 742 0030
customersupport.usa@we-ef.com - <https://we-ef.com/us>

Subject to technical changes and errors. - Generated on 06/08/2025

145-7652

we-ef

FLC311 Surface mounted

Optical Accessories

Softening Lens

Description	Part ID	C1
Flood lens IO-360 for [EE]	145-7786	59

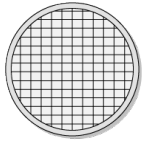

C1

Flood lens IO-360 for [EES]	145-7780	59
-----------------------------	----------	----

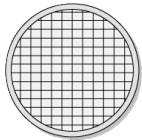

C1

WE-EF LIGHTING USA, LLC

410-D Keystone Drive, 15086 Warrendale, PA 15086 - Phone: +1 724 742 0030
customersupport.usa@we-ef.com - <https://we-ef.com/us>

Subject to technical changes and errors. - Generated on 06/08/2025

145-7652

we-ef

FLC311 Surface mounted

Linear spread lens

Description	Part ID	C1
Linear spread lens IO-180	145-7781	59

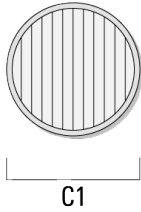

Wallwash lens

Description	Part ID	C1
Wallwash lens IO-20	145-7782	59

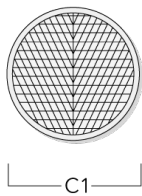

WE-EF LIGHTING USA, LLC

410-D Keystone Drive, 15086 Warrendale, PA 15086 - Phone: +1 724 742 0030
customersupport.usa@we-ef.com - <https://we-ef.com/us>
Subject to technical changes and errors. - Generated on 06/08/2025

FLC311 Surface mounted

Honeycomb louvre

Description	Part ID	C1
Honeycomb louvre IW	145-7783	59

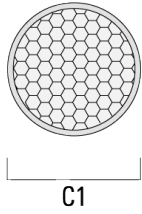

Glare shield

Description	Part ID	A	C1
Glare shield ES	145-7784	34	85

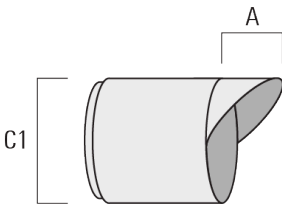

145-7652

we-ef

FLC311 Surface mounted

Snoot

Description	Part ID	A	C1
Snoot ET	145-7785	34	85

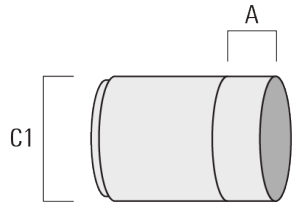

WE-EF LIGHTING USA, LLC

410-D Keystone Drive, 15086 Warrendale, PA 15086 - Phone: +1 724 742 0030
customersupport.usa@we-ef.com - <https://we-ef.com/us>
Subject to technical changes and errors. - Generated on 06/08/2025