

145-7750

FLC311 Space frame

we-ef

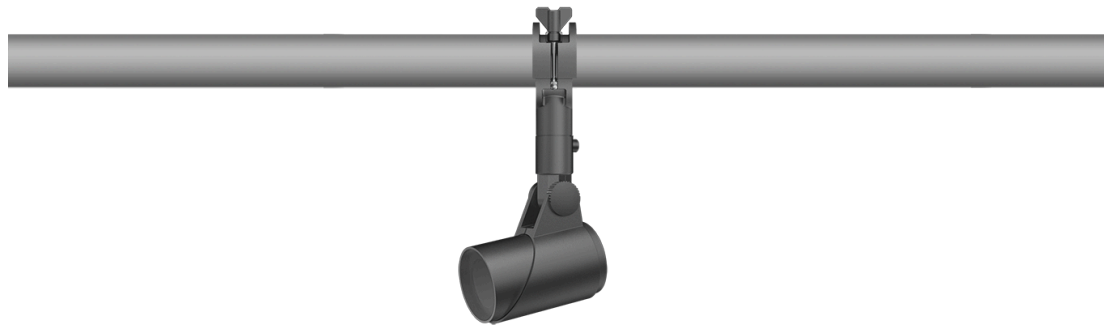

Description

IP66. IK08. Marine-grade, die-cast aluminium alloy. 5CE superior corrosion protection including PCS hardware. Safety glass lens. Silicone CCG® Controlled Compression Gasket. Luminaire is factory-sealed and does not need to be opened during installation.

Integral EC electronic converter in thermally-separated compartment. Advanced thermal management protects LEDs while optimising lumens output. CAD-optimised optics for superior illumination and glare control.

Mains voltage versions, ON-OFF Class I. 1-10 V analogue dimming or DALI interface available on request; refer to accessory listings.

Optical accessories are factory-installed. To be specified at time of ordering.

Including terminal box, for mounting on \varnothing 48-60 mm pipes or space frames.

Weight	2.50 kg
Light distribution	symmetric, wide beam [B]
Light source	LED-3/6W / 180 mA - 4000 K
CRI	80
Power supply	EC
LEDs	3
Rated input power	7.5 W
Nominal Lumen (lm)	
LED Lumen	280
Total Lumen	840
Tj	85
Rated lumens (lm)	
LED Lumen	213.7
Total Lumen	641.2
Ta	25

WE-EF LEUCHTEN GmbH

Töpinger Straße 16, 29646 Bispingen, Germany - Phone: +49 5194 909-0
info@we-ef.com - <https://we-ef.com>

Subject to technical changes and errors. - Generated on 23/11/2024

145-7750



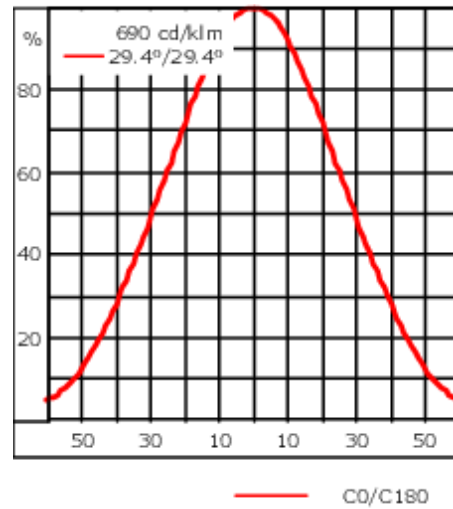
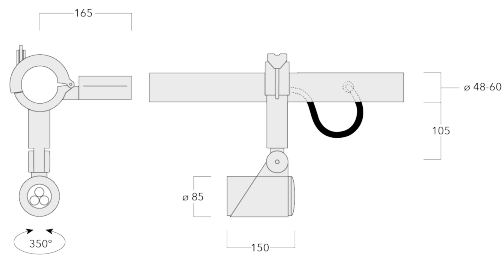

FLC311 Space frame

we-ef



Specifications

Material description

Body	Marine-grade, die-cast aluminium alloy
Lens	Safety glass lens
Colours	 RAL9004 Signal black  RAL9006 White aluminium  RAL9007 Grey aluminium  RAL7016 Anthracite grey  RAL9016 Traffic white
Gasket	Silicone CCG® Controlled Compression Gasket
Fasteners	PCS hardware
Ingress protection	IP66
Impact resistance	IK08
Corrosion resistance	5CE
Windage	0.045 m ²

Electrical description

Driver / Ballast	Integral EC electronic converter
------------------	----------------------------------

Additional information

Lifetime	Ta=25° L90B10 > 90000h
Energy efficiency class	D-E (Light source)

WE-EF LEUCHTEN GmbH

Töpinger Straße 16, 29646 Bispingen, Germany - Phone: +49 5194 909-0
info@we-ef.com - <https://we-ef.com>

Subject to technical changes and errors. - Generated on 23/11/2024

145-7750

FLC311 Space frame

we-ef

Control

Eco Step Dim® Advanced

Description	Part ID
Eco Step Dim® Advanced LED	430-0002

WE-EF LEUCHTEN GmbH

Töpinger Straße 16, 29646 Bispingen, Germany - Phone: +49 5194 909-0
info@we-ef.com - <https://we-ef.com>

Subject to technical changes and errors. - Generated on 23/11/2024