

145-7750

FLC311 Space frame

we-ef

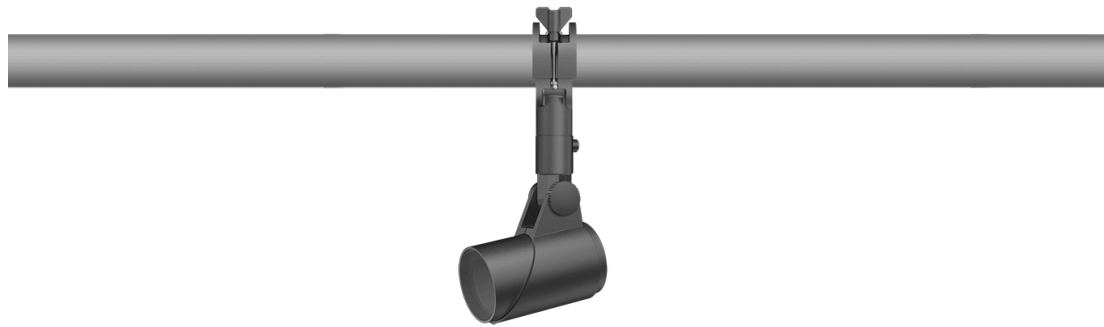

Description

IP66. IK08. Marine-grade, die-cast aluminium alloy. 5CE superior corrosion protection including PCS hardware. Safety glass lens. Silicone CCG® Controlled Compression Gasket. Luminaire is factory-sealed and does not need to be opened during installation.

Integral EC electronic converter in thermally-separated compartment. Advanced thermal management protects LEDs while optimising lumens output. CAD-optimised optics for superior illumination and glare control.

Mains voltage versions: DALI interface Class I.

Including terminal box, for mounting on \varnothing 48-60 mm pipes or space frames.

Optical accessories are factory-installed. To be specified at time of ordering.

Weight	2.50 kg
Light distribution	symmetric, wide beam [B]
Light source	LED-3/6W / 180 mA - 4000 K
CRI	80
Power supply	EC
LEDs	3
Rated input power	7.5 W

Nominal Lumen (lm)

LED Lumen	280
Total Lumen	840
Tj	85

Rated lumens (lm)

LED Lumen	213.7
Total Lumen	641.2
Ta	25

WE-EF LIGHTING Pty Ltd

47 Tarnard Drive, 3195 Braeside, Victoria - Phone: +61 3 8587 0444 - Fax: +61 3 8587 0499

info.australia@we-ef.com - <https://we-ef.com/aus>

Subject to technical changes and errors. - Generated on 19/04/2025

145-7750

FLC311 Space frame

we-ef



Specifications

Material description

Body	Marine-grade, die-cast aluminium alloy
Lens	Safety glass lens
Colours	 RAL9004 Signal black  RAL9006 White aluminium  RAL9007 Grey aluminium
Gasket	Silicone CCG® Controlled Compression Gasket
Fasteners	PCS hardware
Ingress protection	IP66
Impact resistance	IK08
Corrosion resistance	5CE
Windage	0.045 m ²

Electrical description

Driver / Ballast	DALI
------------------	------

Additional information

Lifetime	Ta=40° L90B10 > 90000h
----------	------------------------

WE-EF LIGHTING Pty Ltd

47 Tarnard Drive, 3195 Braeside, Victoria - Phone: +61 3 8587 0444 - Fax: +61 3 8587 0499

info.australia@we-ef.com - <https://we-ef.com/aus>

Subject to technical changes and errors. - Generated on 19/04/2025

145-7750

FLC311 Space frame

we-ef

Control

Eco Step Dim® Advanced

Description	Part ID
Eco Step Dim® Advanced LED	430-0002

1-10 V analogue dimming interface

Description	Part ID	C
1-10 V analogue dimming interface	430-0011	90

0-10 V, 24VDC low voltage version

Description	Part ID
24VDC low voltage version, 0-10 V	0033

WE-EF LIGHTING Pty Ltd

47 Tarnard Drive, 3195 Braeside, Victoria - Phone: +61 3 8587 0444 - Fax: +61 3 8587 0499
info.australia@we-ef.com - <https://we-ef.com/aus>

Subject to technical changes and errors. - Generated on 19/04/2025

145-7750

FLC311 Space frame

we-ef

Optical Accessories

Surface wash lens

Description	Part ID	C1
Flood lens IO-360 for [EE]	145-7786	59



Flood lens IO-360 for [EES]	145-7780	59
-----------------------------	----------	----

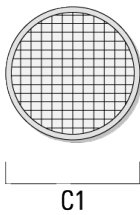

WE-EF LIGHTING Pty Ltd

47 Tarnard Drive, 3195 Braeside, Victoria - Phone: +61 3 8587 0444 - Fax: +61 3 8587 0499

info.australia@we-ef.com - <https://we-ef.com/aus>

Subject to technical changes and errors. - Generated on 19/04/2025

145-7750

FLC311 Space frame

we-ef

Linear spread lens

Description	Part ID	C1
Linear spread lens IO-180	145-7781	59

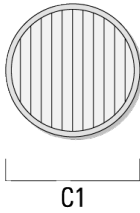

Wallwash lens

Description	Part ID	C1
Wallwash lens IO-20	145-7782	59

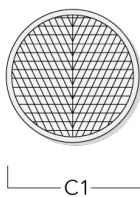

WE-EF LIGHTING Pty Ltd

47 Tarnard Drive, 3195 Braeside, Victoria - Phone: +61 3 8587 0444 - Fax: +61 3 8587 0499

info.australia@we-ef.com - <https://we-ef.com/aus>

Subject to technical changes and errors. - Generated on 19/04/2025

FLC311 Space frame

Honeycomb louvre

Description	Part ID	C1
Honeycomb louvre IW	145-7783	59

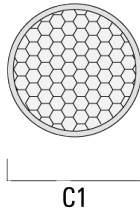

Glare shield

Description	Part ID	A	C1
Glare shield ES	145-7784	34	85

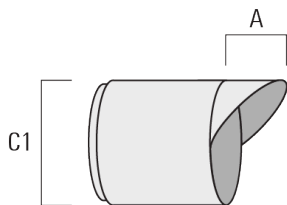

145-7750

FLC311 Space frame

we-ef

Snoot

Description	Part ID	A	C1
Snoot ET	145-7785	34	85

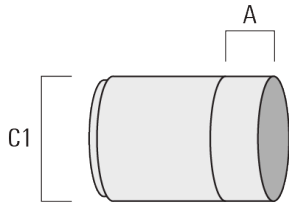

WE-EF LIGHTING Pty Ltd

47 Tarnard Drive, 3195 Braeside, Victoria - Phone: +61 3 8587 0444 - Fax: +61 3 8587 0499

info.australia@we-ef.com - <https://we-ef.com/aus>

Subject to technical changes and errors. - Generated on 19/04/2025