

145-7753

we-ef

FLC311 Space frame

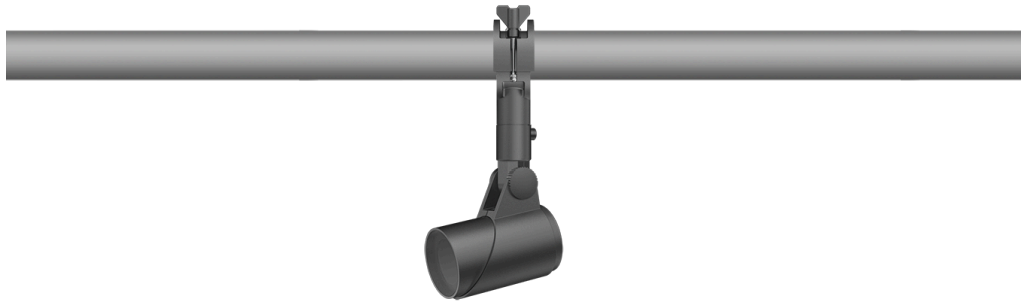

Description

IP66. IK08. Marine-grade, die-cast aluminium alloy. 5CE superior corrosion protection including PCS hardware. Safety glass lens. Silicone CCG® Controlled Compression Gasket. Luminaire is factory-sealed and does not need to be opened during installation.

Integral EC electronic converter in thermally-separated compartment. Advanced thermal management protects LEDs while optimising lumens output. CAD-optimised optics for superior illumination and glare control.

6-12W / 120-277V / 0-10V Dimming.

Optical accessories are factory-installed. To be specified at time of ordering.

Including terminal box, for mounting on \varnothing 1.89-2.36 in pipes or space frames.

Weight	2.50 lb
Light distribution	symmetric, medium beam [M]
Light source	LED-3/6W / 180 mA - 2700 K
CRI	80
Power supply	electronic gear
LEDs	3
Rated input power	7.5 W
Nominal Lumen (lm)	
LED Lumen	260
Total Lumen	780
Tj	85
Rated lumens (lm)	
LED Lumen	200.1
Total Lumen	600.4
Ta	25

WE-EF LIGHTING USA, LLC

410-D Keystone Drive, 15086 Warrendale, PA 15086 - Phone: +1 724 742 0030
customersupport.usa@we-ef.com - <https://we-ef.com/us>
Subject to technical changes and errors. - Generated on 11/23/2024

145-7753

we-ef

FLC311 Space frame

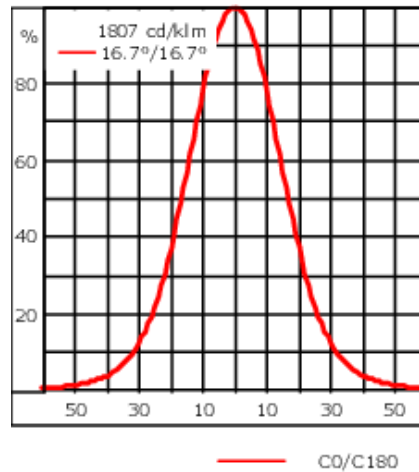
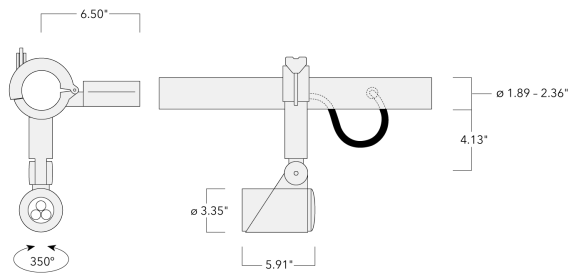

Specifications

Material description

Body	Marine-grade, die-cast aluminium alloy
Lens	Safety glass lens
Colors	<div style="display: flex; align-items: center;"> <div style="width: 20px; height: 10px; background-color: black; margin-right: 5px;"></div> RAL9004 Black </div> <div style="display: flex; align-items: center; margin-top: 5px;"> <div style="width: 20px; height: 10px; background-color: grey; margin-right: 5px;"></div> RAL9007 Grey Metallic </div> <div style="display: flex; align-items: center; margin-top: 5px;"> <div style="width: 20px; height: 10px; background-color: white; border: 1px solid black; margin-right: 5px;"></div> RAL9016 White </div>
Gasket	Silicone CCG® Controlled Compression Gasket
Fasteners	PCS hardware
Ingress protection	IP66
Impact resistance	IK08
Corrosion resistance	5CE
Windage	0.484 ft ²

Electrical description

Driver / Ballast	Integral [ECG] electronic driver 120V-277V.
------------------	---

Additional information

Lifetime	Ta=25°/40° L90B10 > 90000h
Listings	ETL, UL-1598, CSA-C22.2#250.0. Suitable for Wet Locations.

WE-EF LIGHTING USA, LLC

410-D Keystone Drive, 15086 Warrendale, PA 15086 - Phone: +1 724 742 0030
customersupport.usa@we-ef.com - <https://we-ef.com/us>
Subject to technical changes and errors. - Generated on 11/23/2024