

145-7755

FLC311 Space frame

**we-ef**

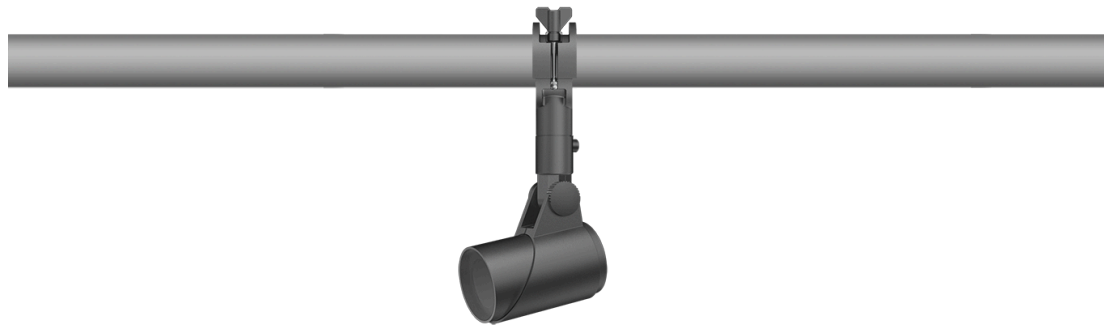

#### Description

IP66. IK08. Marine-grade, die-cast aluminium alloy. 5CE superior corrosion protection including PCS hardware. Safety glass lens. Silicone CCG® Controlled Compression Gasket. Luminaire is factory-sealed and does not need to be opened during installation.

Integral EC electronic converter in thermally-separated compartment. Advanced thermal management protects LEDs while optimising lumens output. CAD-optimised optics for superior illumination and glare control.

Mains voltage versions, ON-OFF Class I. 1-10 V analogue dimming or DALI interface available on request; refer to accessory listings.

Including terminal box, for mounting on  $\varnothing$  48-60 mm pipes or space frames.

Optical accessories are factory-installed. To be specified at time of ordering.

Weight	2.50 kg
Light distribution	symmetric, medium beam [M]
Light source	LED-3/12W / 350 mA - 2700 K
CRI	80
Power supply	EC
LEDs	3
Rated input power	13.9 W
<b>Nominal Lumen (lm)</b>	
LED Lumen	490
Total Lumen	1470
Tj	85
<b>Rated lumens (lm)</b>	
LED Lumen	377.2
Total Lumen	1131.6
Ta	25

**WE-EF LIGHTING (Thailand) Co., Ltd.**

57 Moo 5, Kingkaew Rd., Bangplee, 10540 Samutprakarn - Phone: +66 2 738 96 20 - Fax: +66 2 738 96 29

<https://we-ef.com/asia>

Subject to technical changes and errors. - Generated on 23/11/2024

145-7755



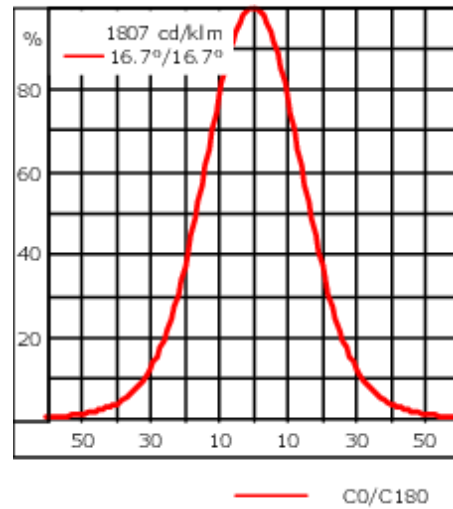
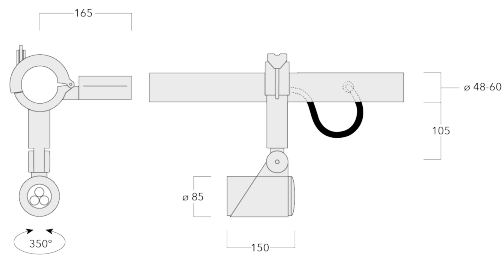

## FLC311 Space frame

**we-ef**



## Specifications

### Material description

Body	Marine-grade, die-cast aluminium alloy
Lens	Safety glass lens
Colours	 RAL9004 Signal black  RAL9007 Grey aluminium  RAL7016 Anthracite grey  RAL9016 Traffic white
Gasket	Silicone CCG® Controlled Compression Gasket
Fasteners	PCS hardware
Ingress protection	IP66
Impact resistance	IK08
Corrosion resistance	5CE
Windage	0.045 m <sup>2</sup>

### Electrical description

Driver / Ballast	Integral EC electronic converter in thermally-separated compartment
------------------	---

### Additional information

Lifetime	Ta=25° L90B10 > 90000h
----------	------------------------

#### WE-EF LIGHTING (Thailand) Co., Ltd.

57 Moo 5, Kingkaew Rd., Bangplee, 10540 Samutprakarn - Phone: +66 2 738 96 20 - Fax: +66 2 738 96 29

<https://we-ef.com/asia>

Subject to technical changes and errors. - Generated on 23/11/2024

**145-7755**

**FLC311 Space frame**

**we-ef**

## **Control**

### **1-10 V analogue dimming interface**

Description	Part ID
1-10 V analogue dimming interface	430-0011

**WE-EF LIGHTING (Thailand) Co., Ltd.**

57 Moo 5, Kingkaew Rd., Bangplee, 10540 Samutprakarn - Phone: +66 2 738 96 20 - Fax: +66 2 738 96 29

<https://we-ef.com/asia>

Subject to technical changes and errors. - Generated on 23/11/2024