

145-7765

FLC311 Space frame

we-ef

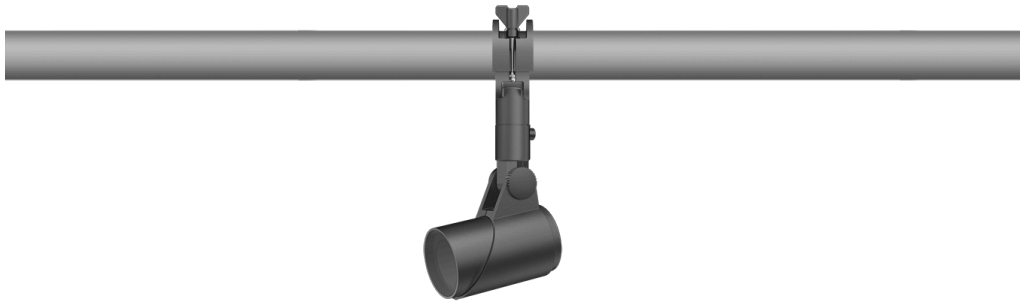

Description

IP66. IK08. Marine-grade, die-cast aluminium alloy. 5CE superior corrosion protection including PCS hardware. Safety glass lens. Silicone CCG® Controlled Compression Gasket. Luminaire is factory-sealed and does not need to be opened during installation.

Integral EC electronic converter in thermally-separated compartment. Advanced thermal management protects LEDs while optimising lumens output. CAD-optimised optics for superior illumination and glare control.

6-12W / 120-277V / 0-10V Dimming.

Optical accessories are factory-installed. To be specified at time of ordering.

Including terminal box, for mounting on \varnothing 1.89-2.36 in pipes or space frames.

Weight	2.50 lb
Light distribution	symmetric, very narrow beam [VN]
Light source	LED-3/6W / 180 mA - 3000 K
CRI	80
Power supply	electronic gear
LEDs	3
Rated input power	7.5 W
Nominal Lumen (lm)	
LED Lumen	260
Total Lumen	780
Tj	85
Delivered lumens (lm)	
LED Lumen	201.7
Total Lumen	605.2
Ta	25

WE-EF LIGHTING USA, LLC

410-D Keystone Drive, 15086 Warrendale, PA 15086 - Phone: +1 724 742 0030
customersupport.usa@we-ef.com - <https://we-ef.com/us>
Subject to technical changes and errors. - Generated on 06/08/2025

145-7765

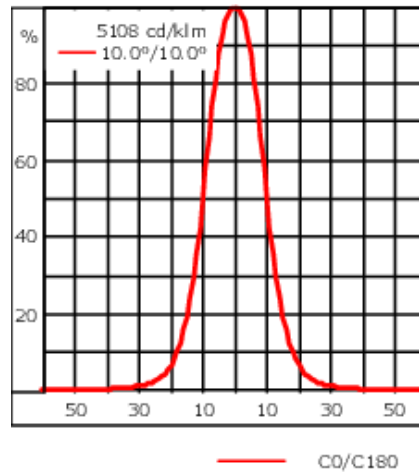
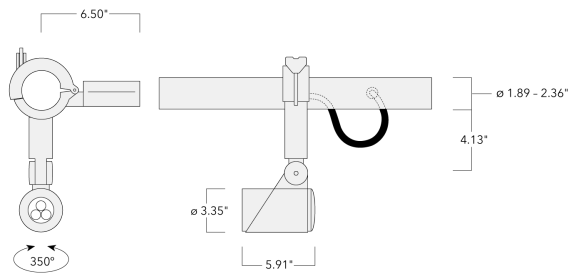

we-ef

FLC311 Space frame



Specifications

Material description

Body	Marine-grade, die-cast aluminium alloy
Lens	Safety glass lens
Colors	 RAL9004 Black  RAL9007 Grey Metallic  RAL9016 White
Gasket	Silicone CCG® Controlled Compression Gasket
Fasteners	PCS hardware
Ingress protection	IP66
Impact resistance	IK08
Corrosion resistance	5CE
Windage	0.484 ft ²

Electrical description

Driver / Ballast	Integral [ECG] electronic driver 120V-277V.
------------------	---

Additional information

Lifetime	Ta=25°/40° L90B10 > 90000h
Listings	ETL, UL-1598, CSA-C22.2#250.0. Suitable for Wet Locations.

WE-EF LIGHTING USA, LLC

410-D Keystone Drive, 15086 Warrendale, PA 15086 - Phone: +1 724 742 0030
customersupport.usa@we-ef.com - <https://we-ef.com/us>
Subject to technical changes and errors. - Generated on 06/08/2025

145-7765

FLC311 Space frame

Optical Accessories

Softening Lens

Description	Part ID	C1
Flood lens IO-360 for [EE]	145-7786	59

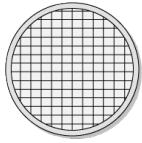

C1

Flood lens IO-360 for [EES]	145-7780	59
-----------------------------	----------	----

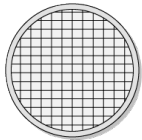

C1

WE-EF LIGHTING USA, LLC

410-D Keystone Drive, 15086 Warrendale, PA 15086 - Phone: +1 724 742 0030
customersupport.usa@we-ef.com - <https://we-ef.com/us>
Subject to technical changes and errors. - Generated on 06/08/2025

145-7765

we-ef

FLC311 Space frame

Linear spread lens

Description	Part ID	C1
Linear spread lens IO-180	145-7781	59

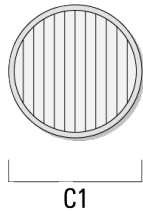

Wallwash lens

Description	Part ID	C1
Wallwash lens IO-20	145-7782	59

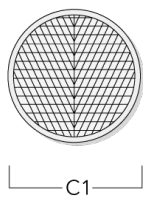

WE-EF LIGHTING USA, LLC

410-D Keystone Drive, 15086 Warrendale, PA 15086 - Phone: +1 724 742 0030
customersupport.usa@we-ef.com - <https://we-ef.com/us>
Subject to technical changes and errors. - Generated on 06/08/2025

145-7765

we-ef

FLC311 Space frame

Honeycomb louvre

Description	Part ID	C1
Honeycomb louvre IW	145-7783	59

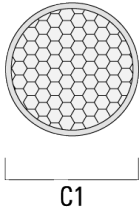

Glare shield

Description	Part ID	A	C1
Glare shield ES	145-7784	34	85

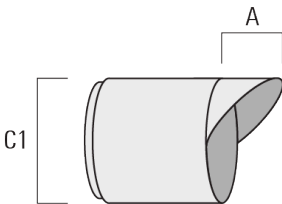

WE-EF LIGHTING USA, LLC

410-D Keystone Drive, 15086 Warrendale, PA 15086 - Phone: +1 724 742 0030
customersupport.usa@we-ef.com - <https://we-ef.com/us>
Subject to technical changes and errors. - Generated on 06/08/2025

145-7765

we-ef

FLC311 Space frame

Snoot

Description	Part ID	A	C1
Snoot ET	145-7785	34	85

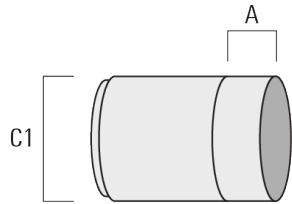

WE-EF LIGHTING USA, LLC

410-D Keystone Drive, 15086 Warrendale, PA 15086 - Phone: +1 724 742 0030
customersupport.usa@we-ef.com - <https://we-ef.com/us>

Subject to technical changes and errors. - Generated on 06/08/2025

145-7765

we-ef

FLC311 Space frame

Control

0-10 V, 24VDC low voltage version

Description	Part ID
24VDC low voltage version, 0-10 V	0033

WE-EF LIGHTING USA, LLC

410-D Keystone Drive, 15086 Warrendale, PA 15086 - Phone: +1 724 742 0030
customersupport.usa@we-ef.com - <https://we-ef.com/us>
Subject to technical changes and errors. - Generated on 06/08/2025