

Description

IP66. Class I / II. IK08. Marine-grade, die-cast aluminium alloy. 5CE superior corrosion protection + primer including PCS hardware. RFC™ Reflection Free Contour main lens. Silicone CCG® Controlled Compression Gasket. Luminaire is factory-sealed and does not need to be opened during installation.

Integral EC electronic converter. DALI. Advanced thermal management protects LEDs while optimising lumens output. LED board can be easily removed for upgrading. CAD- optimised OLC® optics for superior illumination and glare control. Optional 2200 K version up to max. 1050mA available. To be specified at time of ordering.

Maximum spacing for streetlighting applications depends on wattage and light distribution.

Please note that the luminaire requires a mounting bracket for installation. This bracket needs to be ordered separately. Please choose from one of our various options listed under Mounting Accessories

Weight	7.50 kg
Light distribution	asymmetric, side throw [S65]
Light source	LED-18/18W / 350 mA - 4000 K
CRI	80
Power supply	EC
LEDs	18
Rated input power	21 W

Nominal Lumen (lm)

LED Lumen	170
Total Lumen	3060
Tj	85

Rated lumens (lm)

LED Lumen	153.5
Total Lumen	2763.2
Ta	25

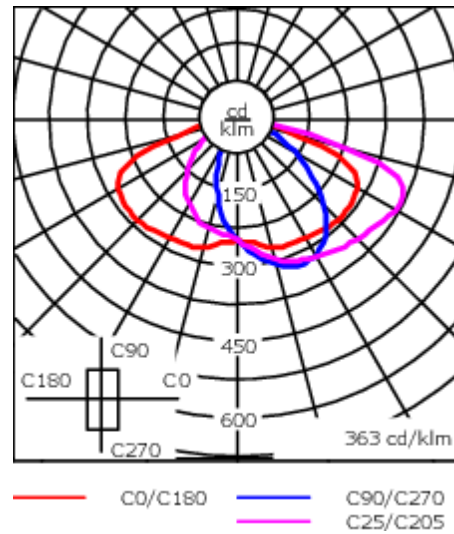
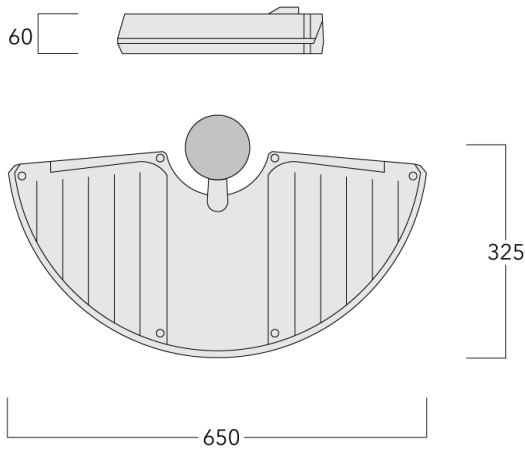

Specifications

Material description

Body	Marine-grade, die-cast aluminium alloy
Lens	RFC® Reflection Free Contour technology
Colours	<div style="display: flex; align-items: center;"> <div style="width: 20px; height: 15px; background-color: black; margin-right: 5px;"></div> RAL9004 Signal black </div> <div style="display: flex; align-items: center; margin-top: 5px;"> <div style="width: 20px; height: 15px; background-color: #cccccc; margin-right: 5px;"></div> RAL9006 White aluminium </div> <div style="display: flex; align-items: center; margin-top: 5px;"> <div style="width: 20px; height: 15px; background-color: #808080; margin-right: 5px;"></div> RAL9007 Grey aluminium </div>
Gasket	Silicone CCG® Controlled Compression Gasket
Fasteners	PCS Polymer Coated Stainless Steel Hardware
Ingress protection	IP66
Impact resistance	IK08
Corrosion resistance	5CE+Primer

Electrical description

Power supply	220-240V / 50-60 Hz
Driver / Ballast	Integral EC electronic converter. DALI
Power factor	> 0.9
Surge protection	In-pole surge protection SP10 device supplied. Please refer to WE-EF installation instructions for details. Use suffix +A for Integral surge protection.

Additional information

Lifetime	Ta=40° L90B10 > 90000h
----------	------------------------

WE-EF LIGHTING Pty Ltd

Mounting Accessories

Wall and pole brackets RM

Description	Part ID	C1	C2	C3	D1	D × L1	H1	H2	M1	Weight (kg)
RM1-76 Pole bracket, single	105-9849				114	76 x 80				1.20

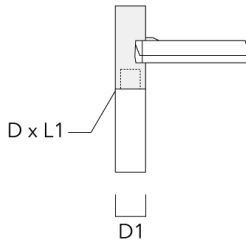

RM1-76 Pole bracket, single	105-9847				102	76 x 80				1.00
-----------------------------	----------	--	--	--	-----	---------	--	--	--	------

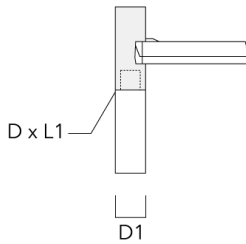

Description	Part ID	C1	C2	C3	D1	D × L1	H1	H2	M1	Weight (kg)
RM1-S Pole bracket, short	105-9845	50			≥ 76		150	124	11	0.60

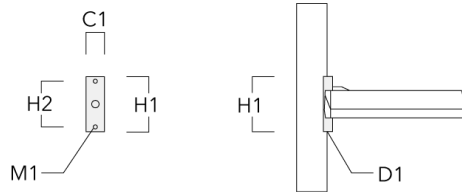

RM1-W Wall bracket, single	105-9846	375	105	80			175	155	6	1.30
----------------------------	----------	-----	-----	----	--	--	-----	-----	---	------

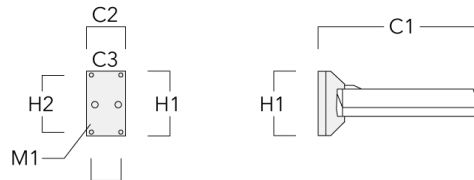

105-9790

RMC320 LED

we-ef

Description	Part ID	C1	C2	C3	D1	D × L1	H1	H2	M1	Weight (kg)
RM2-76 Pole bracket, double	105-9848				102	76 x 80				1.00

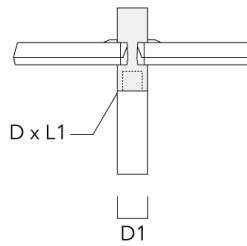

105-9790

RMC320 LED

we-ef

Control

Eco Step Dim® Basic

Description	Part ID
Eco Step Dim® Basic LED	430-0001

Eco Step Dim® Advanced

Description	Part ID
Eco Step Dim® Advanced LED	430-0002

WE-EF LIGHTING Pty Ltd

6/13 Downard Street, 3195 Braeside, Victoria - Phone: +61 3 8587 0444 - Fax: +61 3 8587 0499

info.australia@we-ef.com - <https://we-ef.com/aus>

Subject to technical changes and errors. - Generated on 23/11/2024

105-9790

RMC320 LED

we-ef

Optical Accessories

Light shield

Description	Part ID	Additional information
LS180-[A60]	003-4018	Glare Shield for backlight spill. Glare Shield factory-installed or available as retrofit kit. Suitable for [A60] lenses. Must be specified at time of ordering.
LS180	003-4019	Glare Shield for backlight spill. Glare Shield factory-installed or available as retrofit kit. Suitable for [S60], [S65], [S70], [R65], [P65] lenses. Must be specified at time of ordering.

WE-EF LIGHTING Pty Ltd

6/13 Downard Street, 3195 Braeside, Victoria - Phone: +61 3 8587 0444 - Fax: +61 3 8587 0499

info.australia@we-ef.com - <https://we-ef.com/aus>

Subject to technical changes and errors. - Generated on 23/11/2024