

105-9791

RMC320 LED

we-ef

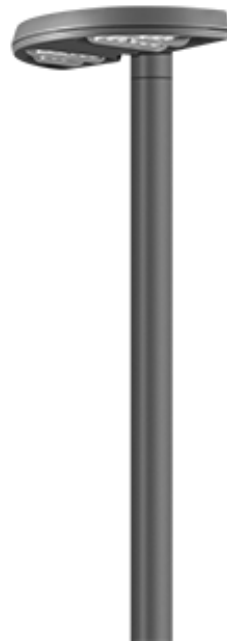

Description

IP66, Class I or Class II. IK08. Marine-grade, die-cast aluminium alloy. 5CE superior corrosion protection including PCS hardware. Silicone CCG® Controlled Compression Gasket. RFC® Reflection Free Contour main lens. Integral EC electronic converter. DALI. CAD-optimised OLC® One LED Concept optics for superior illumination and glare control. Factory installed LED circuit board. The luminaire is factory-sealed and does not need to be opened during installation.

Optional 2200 K version up to max. 1050mA available. To be specified at time of ordering.

The optional brackets RM are required for mounting. To be ordered separately.

Weight	7.50 kg
Light distribution	asymmetric, side throw beam [S65]
Light source	LED-18/36W / 700 mA - 4000 K
CRI	80
Power supply	EC
LEDs	18
Rated input power	41 W

Nominal Lumen (lm)

LED Lumen	310
Total Lumen	5580
Tj	85

Rated lumens (lm)

LED Lumen	266.6
Total Lumen	4799
Ta	25

Fagerhult Lighting Ltd

33-34 Dolben Street, SE1 0UQ London, United Kingdom

<https://we-ef.com/uk>

Subject to technical changes and errors. - Generated on 23/11/2024

105-9791



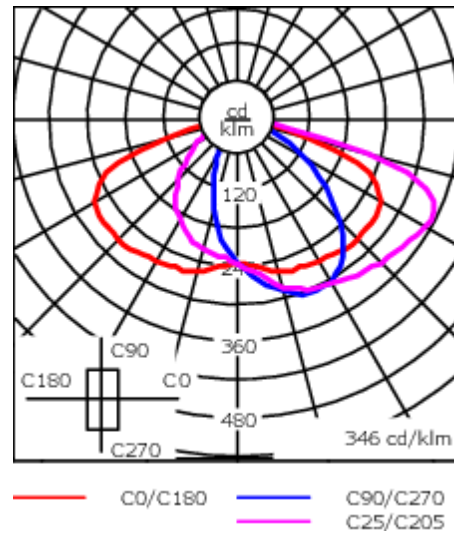
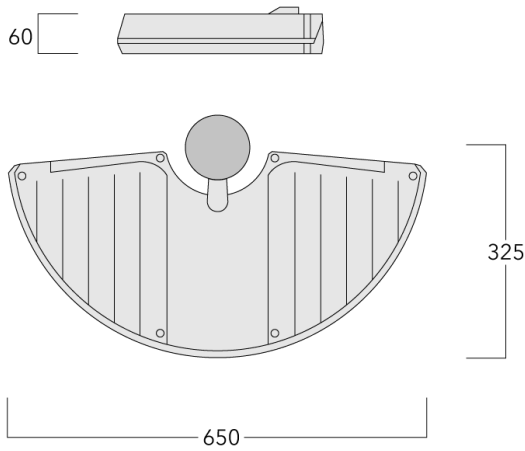

RMC320 LED

we-ef



Specifications

Material description

Body	Marine-grade, die-cast aluminium alloy
Lens	RFC® Reflection Free Contour technology
Colours	 RAL9004 Signal black  RAL9006 White aluminium  RAL9007 Grey aluminium  RAL7016 Anthracite grey  RAL9016 Traffic white
Gasket	Silicone CCG® Controlled Compression Gasket
Fasteners	PCS Polymer Coated Stainless Steel Hardware
Ingress protection	IP66
Impact resistance	IK08
Corrosion resistance	5CE
Windage	0.046 m ²

Electrical description

Power supply	220-240V / 50-60 Hz
Driver / Ballast	Integral EC electronic converter. DALI
Power factor	> 0.9
Surge protection	6/6 kV (optional SP10)

Fagerhult Lighting Ltd

33-34 Dolben Street, SE1 0UQ London, United Kingdom

<https://we-ef.com/uk>

Subject to technical changes and errors. - Generated on 23/11/2024

105-9791

RMC320 LED

we-ef

Additional information

Lifetime Ta=25° L90B10 > 90000h

Energy efficiency class C-D (Light source)

105-9791

RMC320 LED

we-ef

Control

Eco Step Dim® Basic

Description	Part ID
Eco Step Dim® Basic LED	430-0001

Eco Step Dim® Advanced

Description	Part ID
Eco Step Dim® Advanced LED	430-0002

Fagerhult Lighting Ltd

33-34 Dolben Street, SE1 0UQ London, United Kingdom

<https://we-ef.com/uk>

Subject to technical changes and errors. - Generated on 23/11/2024

Mounting Accessories

Wall and pole brackets RM

Description	Part ID	C1	C2	C3	D1	D × L1	H1	H2	M1	Weight (kg)
RM1-76 Pole bracket, single	105-9847				102	76 x 80				1.00

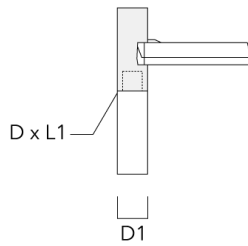

RM1-S Pole bracket, short	105-9845	50			≥ 76		150	124	11	0.60
---------------------------	----------	----	--	--	------	--	-----	-----	----	------

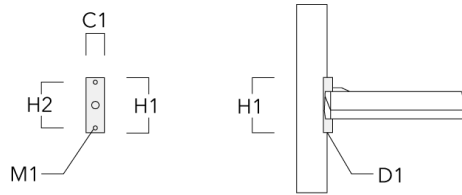

Description	Part ID	C1	C2	C3	D1	D × L1	H1	H2	M1	Weight (kg)
RM1-W Wall bracket, single	105-9846	375	105	80			175	155	6	1.30

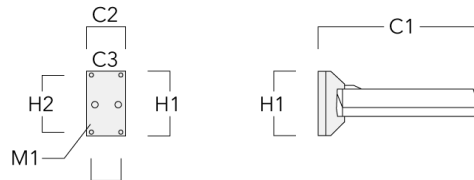

RM2-76 Pole bracket, double	105-9848				102	76 x 80				1.00
-----------------------------	----------	--	--	--	-----	---------	--	--	--	------

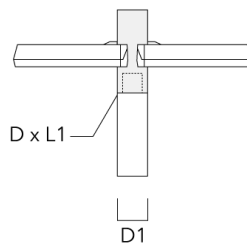

105-9791

RMC320 LED

we-ef

Optical Accessories

Light shield

Description	Part ID	Additional information
LS180-[A60]	430-0038	Light shield LS180 to greatly reduce or eliminate light pollution. PA injection moulded component, black matt. Suitable for asymmetric light distribution [A60].
LS180	430-0029	Glare Shield for backlight spill. Glare Shield factory-installed or available as retrofit kit. Suitable for [S60], [S65], [S70], [R65], [P65] lenses. Must be specified at time of ordering.

Fagerhult Lighting Ltd

33-34 Dolben Street, SE1 0UQ London, United Kingdom

<https://we-ef.com/uk>

Subject to technical changes and errors. - Generated on 23/11/2024