



### Description

IP66. IK07. Marine-grade, die-cast aluminium alloy. 5CE superior corrosion protection including PCS hardware. Safety glass lens. Silicone CCG® Controlled Compression Gasket. Luminaire is factory-sealed and does not need to be opened during installation. Knuckle permits 340° rotation, forward tilt 73° and backward tilt 90°.

Advanced thermal management protects LEDs while optimising lumens output. CAD-optimised optics for superior illumination and glare control. Including 1.5 m of flexible PVC free cable.

Mains voltage versions, ON-OFF Class I. Integral EC electronic converter.

Optical accessories are factory-installed. To be specified at time of ordering.

|                           |                            |
|---------------------------|----------------------------|
| Weight                    | 0.70 kg                    |
| Light distribution        | wallwash                   |
| Light source              | LED-1/4W / 350 mA - 4000 K |
| CRI                       | 80                         |
| Power supply              | EC                         |
| LEDs                      | 1                          |
| Rated input power         | 5 W                        |
| <b>Rated lumens (lm)</b>  |                            |
| LED Lumen                 | 358.8                      |
| Total Lumen               | 358.8                      |
| Ta                        | 25                         |
| <b>Nominal Lumen (lm)</b> |                            |
| LED Lumen                 | 530                        |
| Total Lumen               | 530                        |
| Tc                        | 25                         |

**FLC301 Spigot mounted**

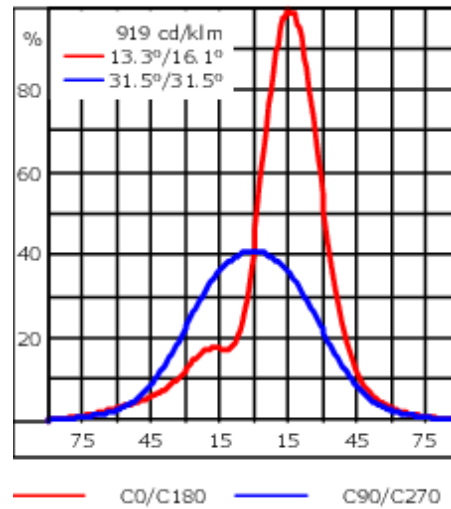
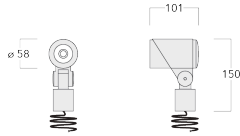

**Specifications**

**Material description**

|                      |  |
|----------------------|--|
| Body                 | Marine-grade, die-cast aluminium alloy   |
| Lens                 | Safety glass lens  |
| Colours              | <div style="display: flex; flex-direction: column; gap: 5px;"> <div style="display: flex; align-items: center;"> <div style="width: 20px; height: 10px; background-color: black; margin-right: 5px;"></div> <span>RAL9004 Signal black</span> </div> <div style="display: flex; align-items: center;"> <div style="width: 20px; height: 10px; background-color: #cccccc; margin-right: 5px;"></div> <span>RAL9006 White aluminium</span> </div> <div style="display: flex; align-items: center;"> <div style="width: 20px; height: 10px; background-color: #808080; margin-right: 5px;"></div> <span>RAL9007 Grey aluminium</span> </div> <div style="display: flex; align-items: center;"> <div style="width: 20px; height: 10px; background-color: #333333; margin-right: 5px;"></div> <span>RAL7016 Anthracite grey</span> </div> <div style="display: flex; align-items: center;"> <div style="width: 20px; height: 10px; background-color: #e0e0e0; margin-right: 5px;"></div> <span>RAL9016 Traffic white</span> </div> </div> |
| Gasket               | Silicone CCG® Controlled Compression Gasket  |
| Fasteners            | PCS hardware   |
| Ingress protection   | IP66   |
| Impact resistance    | IK07   |
| Corrosion resistance | 5CE  |
| Windage              | 0.015 m <sup>2</sup>   |

**Electrical description**

|                  |                                  |
|------------------|----------------------------------|
| Driver / Ballast | Integral EC electronic converter |
| Power factor     | >0.9                             |

**Additional information**

|                         |                        |
|-------------------------|------------------------|
| Lifetime                | Ta=25° L90B10 > 90000h |
| Energy efficiency class | D-E (Light source)     |

**Mounting Accessories**

**Flat surface and Column fitter**

| Description          | Part ID  | A  | B | Weight (kg) |
|----------------------|----------|----|---|-------------|
| Column fitter FLC300 | 145-9536 | 70 |   | 0.20        |

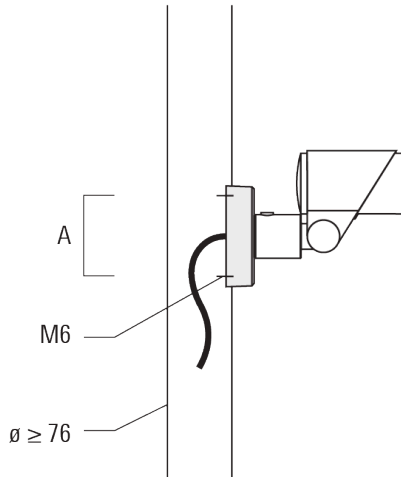

|                            |          |     |    |      |
|----------------------------|----------|-----|----|------|
| Flat surface fitter FLC300 | 145-9535 | 100 | 85 | 0.20 |
|----------------------------|----------|-----|----|------|

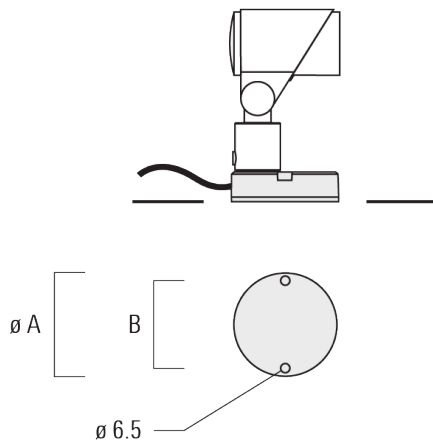

**FLC301 Spigot mounted**

**Ground spike EF**

| Description                 | Part ID  | A   | Weight (kg) |
|-----------------------------|----------|-----|-------------|
| Ground spike EF1 for FLC300 | 310-9102 | 270 | 1.20        |



**Junction box JB1**

| Description                      | Part ID  | A   | B  | C1  | D1 | Weight (kg) |
|----------------------------------|----------|-----|----|-----|----|-------------|
| Junction box JB1 with side entry | 310-9002 | 107 | 67 | 135 | 67 | 1.20        |



145-7185+145-7230

**we-ef**

**FLC301 Spigot mounted**

| Description                      | Part ID  | A   | B  | C1  | D1 | Weight (kg) |
|----------------------------------|----------|-----|----|-----|----|-------------|
| Junction box JB1 with wall entry | 310-9025 | 107 | 67 | 135 | 67 | 1.10        |



145-7185+145-7230

FLC301 Spigot mounted

**we-ef**

## Optical Accessories

### Linear spread lens

| Description               | Part ID  | C1   |
|---------------------------|----------|------|
| Linear spread lens IO-180 | 145-7229 | 42.5 |

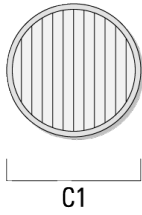

### Wallwash lens

| Description         | Part ID  | C1   |
|---------------------|----------|------|
| IO-20-WW-FLC301-LED | 145-7230 | 42.5 |



#### Fagerhult Lighting Ltd

33-34 Dolben Street, SE1 0UQ London, United Kingdom

<https://we-ef.com/uk>

Subject to technical changes and errors. - Generated on 23/11/2024

**FLC301 Spigot mounted**

**Honeycomb louvre**

| Description         | Part ID  | C1   |
|---------------------|----------|------|
| Honeycomb louvre IW | 145-7231 | 42.5 |

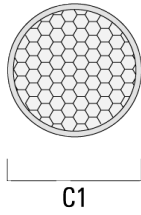

**Glare shield**

| Description     | Part ID  | A    | C1 |
|-----------------|----------|------|----|
| Glare shield ES | 145-7232 | 20.5 | 58 |

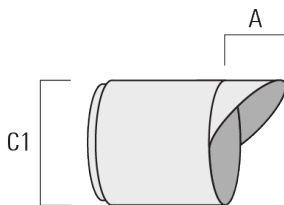

145-7185+145-7230

**we-ef**

FLC301 Spigot mounted

**Snoot**

---

| Description | Part ID  | A    | C1 |
|-------------|----------|------|----|
| Snoot ET    | 145-7233 | 22.5 | 58 |

---

