



Description

IP66, Class I or Class II. IK08. Marine-grade, die-cast aluminium alloy. 5CE superior corrosion protection including PCS hardware. CCG® Controlled Compression Gasket. Non-reflective flat safety glass cover, hinged. Integral EC electronic converter. CAD-optimised optics for superior illumination and glare control. OLC® One LED Concept. Factory installed LED circuit board. The luminaire is factory-sealed and does not need to be opened during installation. Can be used as post top or side entry version. Specification at time of order is recommended.

Spigot Ø 76 x 100 mm. Spigot Ø 60 x 100 mm or 42 x 100 mm option available. Must be indicated during order placement.

Contact WE-EF direct or your local WE-EF sales representative for an individual solution designed to precisely meet your needs.

Photometric files (IES, LDT) for light distributions [S61] [S65] [S66] [S70] [R60] [R61] [P66] [Q66] [A61] with Backlight Shield on request.

Weight	7.00 kg
Light distribution	asymmetric, side throw [S70]
Light source	LED-24/24W / 350 mA - 2700 K
CRI	80
Power supply	EC
LEDs	24
Rated input power	26.5 W

Nominal Lumen (lm)

LED Lumen	145
Total Lumen	3480
Tj	85

Rated lumens (lm)

LED Lumen	134.6
Total Lumen	3229.6
Ta	25

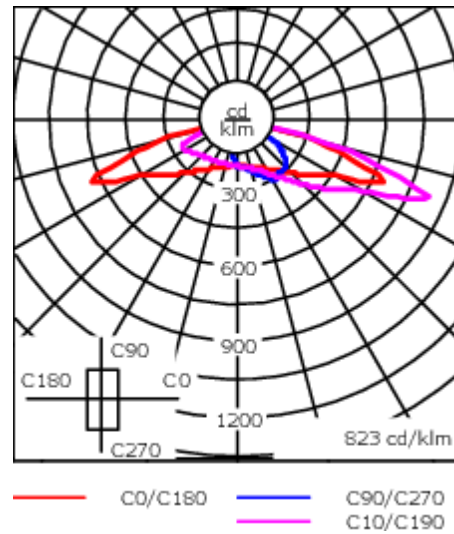
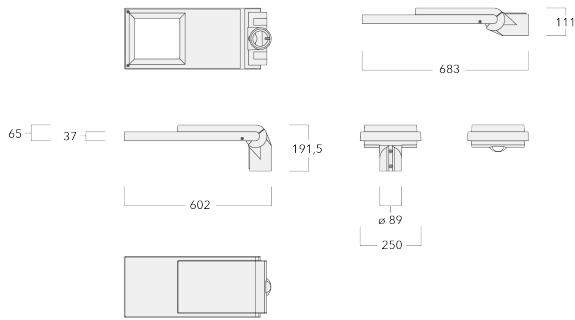

Specifications

Material description

Body	Marine-grade, die-cast aluminium alloy
Lens	Non-reflective safety glass lens
Colours	<div style="display: flex; align-items: center;"> <div style="width: 20px; height: 15px; background-color: black; margin-right: 5px;"></div> RAL9004 Signal black </div> <div style="display: flex; align-items: center;"> <div style="width: 20px; height: 15px; background-color: #cccccc; margin-right: 5px;"></div> RAL9006 White aluminium </div> <div style="display: flex; align-items: center;"> <div style="width: 20px; height: 15px; background-color: #808080; margin-right: 5px;"></div> RAL9007 Grey aluminium </div> <div style="display: flex; align-items: center;"> <div style="width: 20px; height: 15px; background-color: #333333; margin-right: 5px;"></div> RAL7016 Anthracite grey </div> <div style="display: flex; align-items: center;"> <div style="width: 20px; height: 15px; background-color: #e0e0e0; margin-right: 5px;"></div> RAL9016 Traffic white </div>
Gasket	CCG® Controlled Compression Gasket
Fasteners	PCS Polymer Coated Stainless Steel Hardware
Ingress protection	IP66
Impact resistance	IK08
Corrosion resistance	5CE
Windage	0.146 m ²

Electrical description

Power supply	220-240V / 50-60 Hz
Driver / Ballast	Integral EC electronic converter. DALI
Power factor	> 0.9
Surge protection	6/6kV, optional 10kV

Additional information

Lifetime	Ta=25° L90B10 > 90000h
Energy efficiency class	C-D (Light source)

Fagerhult Lighting Ltd

33-34 Dolben Street, SE1 0UQ London, United Kingdom

<https://we-ef.com/uk>

Subject to technical changes and errors. - Generated on 23/11/2024

Control

Eco Step Dim® Advanced

Description	Part ID
Eco Step Dim® Advanced LED	430-0002

R2C Ready to Connect

Description	Part ID
R2C Ready to Connect (top)	430-0019
R2C Ready to Connect (below)	430-0027
R2C Ready to Connect (top and below)	430-0032

Citygrid Motion On Pole

Description	Part ID	Additional information
Citygrid Motion - Entry-Package	420-0011	Citygrid Motion. Das All-in-One Gerät, das vorhandene Leuchten in ein intelligentes Lichtsystem verwandeln kann.

Einstiegs-Paket

WE-EF liefert und konfiguriert Leuchten und Citygrid System einmalig ab Werk bzw. am Einsatzort. Neukonfiguration als Service abrufbar (kostenpflichtig). Gateway/App nicht inbegriffen.

Anwendungen: Kommunale Einzelprojekte, Insellösungen und Feldversuche für Smart Lighting, z.B. einzelne Straßen, Wege oder Plätze. Halböffentliche oder private Projekte, z.B. Firmengelände, Parkplatz.



Description	Part ID	Additional information
Citygrid Motion - Standalone-Package	420-0012	<p>Citygrid Motion On Pole Controller.</p> <p>The Citygrid Motion On Pole Controller is the all-in-one device that can convert existing luminaires into an intelligent lighting system.</p> <p>The standalone package:</p> <p>Dongle & apps included; operators can configure, change and service the Citygrid system themselves (on site) using the apps on their mobile device.</p> <p>Applications: demarcated communal projects (street, square, district) or private projects (larger company sites, commercial estates) if qualified personnel are available for the operation of the system.</p>



Description	Part ID	Additional information
Citygrid Motion - Smart-City-Package	420-0013	<p>Citygrid Motion On Pole Controller</p> <p>The Citygrid Motion On Pole Controller is the all-in-one device that can convert existing luminaires into an intelligent lighting system.</p> <p>The Smart-City package: Internet gateway (via mobile phone) and dashboard included; operators can configure, change and service themselves (remotely). Networked Smart-City functions (data collection, remote maintenance, etc.).</p> <p>Applications: larger communal projects or field trials in the context of Smart City; operator has qualified personnel (municipal utilities).</p>



Citygrid Motion On Luminaire

Description	Part ID	Additional information
Citygrid Motion - Entry-Package	420-0021	<p>Citygrid On Luminaire - Entry Package Citygrid On Luminaire. Die Sensoren erkennen Bewegung und Verkehr beim Betreten des Sensor und Leuchtenfelds.</p> <p>Einstiegs-Paket WE-EF liefert und konfiguriert Leuchten und Citygrid System einmalig ab Werk bzw. am Einsatzort. Neukonfiguration als Service abrufbar (kostenpflichtig). Gateway/App nicht inbegriffen.</p> <p>Anwendungen: Kommunale Einzelprojekte, Insellösungen und Feldversuche für Smart Lighting, z.B. einzelne Straßen, Wege oder Plätze. Halböffentliche oder private Projekte, z.B. Firmengelände, Parkplatz. Citygrid built-in light controller with angled sensors The sensors detect motion and traffic on entering the sensor and lighting field.</p> <p>The entry-level package: WE-EF supplies and configures luminaires and the Citygrid system once ex works or on site. Reconfiguration is available as a service (chargeable). Gateway/app not included.</p> <p>Applications: individual communal projects, isolated solutions and field trials for smart lighting, e.g. single streets, paths or squares. Semi-public or private projects, e.g. company site, car park.</p>

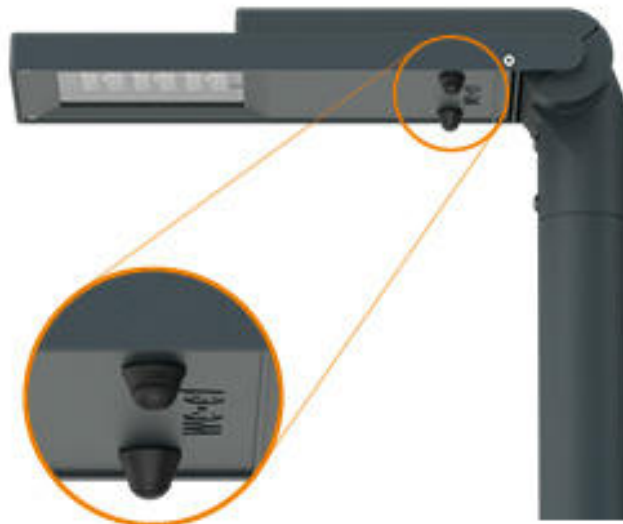

Description	Part ID	Additional information
Citygrid Motion - Standalone-Package	420-0022	<p>Citygrid Motion built-in light controller with angled sensors The sensors detect motion and traffic on entering the sensor and lighting field.</p> <p>The standalone package: Dongle & apps included; operators can configure, change and service the Citygrid system themselves (on site) using the apps on their mobile device. Applications: demarcated communal projects (street, square, district) or private projects (larger company sites, commercial estates) if qualified personnel are available for the operation of the system.</p>



Description	Part ID	Additional information
Citygrid Motion - Smart-City-Package	420-0023	<p>Citygrid Motion built-in light controller with angled sensors The sensors detect motion and traffic on entering the sensor and lighting field.</p> <p>The Smart-City package: Internet gateway (via mobile phone) and dashboard included; operators can configure, change and service themselves (remotely). Networked Smart-City functions (data collection, remote maintenance, etc.). Applications: larger communal projects or field trials in the context of Smart City; operator has qualified personnel (municipal utilities).</p>



Citygrid Motion Zhaga

Description	Part ID	Additional information
Citygrid Motion - Standalone-Package	420-0032	Citygrid Motion Zhaga controller with sensor. The compact all-in-one design turns every luminaire with a Zhaga Book 18 socket facing the street surface into motion-controlled, intelligent street & area lighting.

The standalone package:

Dongle & apps included; operators can configure, change and service the Citygrid system themselves (on site) using the apps on their mobile device.

Applications: demarcated communal projects (street, square, district) or private projects (larger company sites, commercial estates) if qualified personnel are available for the operation of the system.



Description	Part ID	Additional information
Citygrid Motion - Smart-City-Package	420-0033	<p>Citygrid Motion Zhaga controller with sensor.</p> <p>The compact all-in-one design turns every luminaire with a Zhaga Book 18 socket facing the street surface into motion-controlled, intelligent street & area lighting.</p> <p>The Smart-City package: Internet gateway (via mobile phone) and dashboard included; operators can configure, change and service themselves (remotely). Networked Smart-City functions (data collection, remote maintenance, etc.).</p> <p>Applications: larger communal projects or field trials in the context of Smart City; operator has qualified personnel (municipal utilities).</p>



102-0012

AFL120 LED

we-ef

Mounting Accessories

Bird deterrent

Description	Part ID
Bird deterrent BD	430-0015

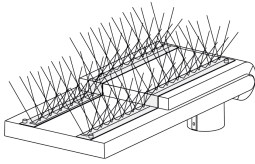

Adaptor

Description	Part ID
Adaptor AFL100	102-0392

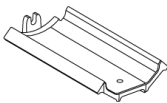

Fagerhult Lighting Ltd

33-34 Dolben Street, SE1 0UQ London, United Kingdom

<https://we-ef.com/uk>

Subject to technical changes and errors. - Generated on 23/11/2024

Wall and pole brackets RE

Description	Part ID	C1	D1	D2	D × L1	H1	M1	Weight (kg)
RE2-540 Pole bracket, double	111-0043	200			76 x 130	550		5.30

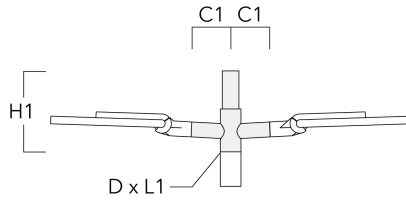

RE0-540 Wall bracket	111-0084	180	230	195		12	3.20	
----------------------	----------	-----	-----	-----	--	----	------	--

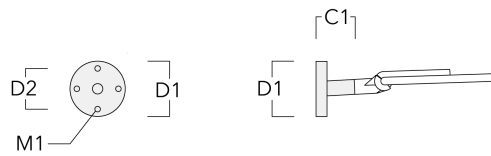

AFL120 LED

Description	Part ID	C1	D1	D2	D × L1	H1	M1	Weight (kg)
RE1-540 Pole bracket, single	111-0042	200			76 x 130	500		4.60

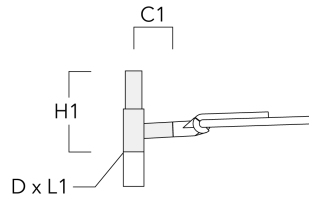

Pole brackets RF

Description	Part ID	C1	D × L1	H1	Weight (kg)
RF2-540 Pole bracket, double	111-0047	200	76 x 80	200	3.30

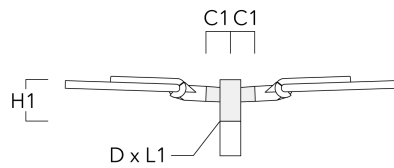

AFL120 LED

Description	Part ID	C1	D × L1	H1	Weight (kg)
RF1-540 Pole bracket, single	111-0046	200	76 x 80	200	2.60

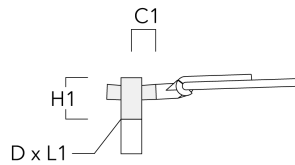

Wall and pole brackets RX

Description	Part ID	C1	D1	D2	D × L1	H1	H2	M1	M2	Weight (kg)
RX1-540 Pole bracket, single	111-0054	1000			76 x 130	550				6.8

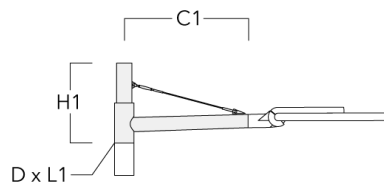

AFL120 LED

Description	Part ID	C1	D1	D2	D × L1	H1	H2	M1	M2	Weight (kg)
RX2-540 Pole bracket, double	111-0055	1000			76 x 130	550				9.70

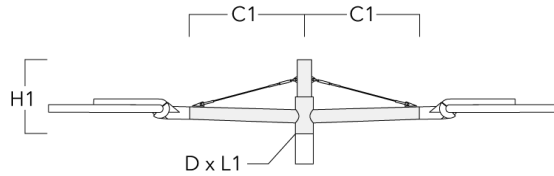

RX0-540 Wall bracket	111-0086	1000	140	100		450	385	30	12	5.20
----------------------	----------	------	-----	-----	--	-----	-----	----	----	------

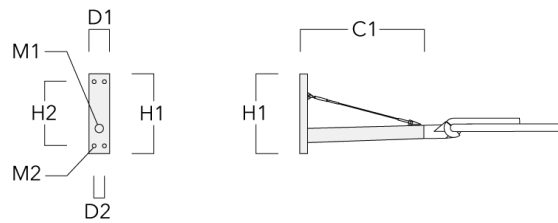

102-0012

AFL120 LED

we-ef

Optical Accessories

Backlight shield

Description	Part ID	Additional information
LS180	430-0029	Glare Shield for backlight spill. Glare Shield factory-installed or available as retrofit kit. Suitable for [S61][S66][R61][P66][Q66][A61] lenses. Must be specified at time of ordering.

