

## AFL120 LED

**Description**

IP66, Class I or Class II. IK08. Marine-grade, die-cast aluminium alloy. 5CE superior corrosion protection including PCS hardware. CCG® Controlled Compression Gasket. Non-reflective flat safety glass cover, hinged. Integral EC electronic converter. CAD-optimised optics for superior illumination and glare control. OLC® One LED Concept. Factory installed LED circuit board. The luminaire is factory-sealed and does not need to be opened during installation. Can be used as post top or side entry version. Specification at time of order is recommended.

Spigot Ø 3" x 4"

Contact WE-EF direct or your local WE-EF sales representative for an individual solution designed to precisely meet your needs.

Weight	15.40 lb
Light distribution	[A61] Type IV Very Short
Light source	LED-24/24W / 350 mA - 2700 K
CRI	80
Power supply	electronic gear
LEDs	24
Rated input power	26.5 W

**Nominal Lumen (lm)**

LED Lumen	145
Total Lumen	3480
Tj	85

**Delivered lumens (lm)**

LED Lumen	130.7
Total Lumen	3136.5
Ta	25

**AFL120 LED**

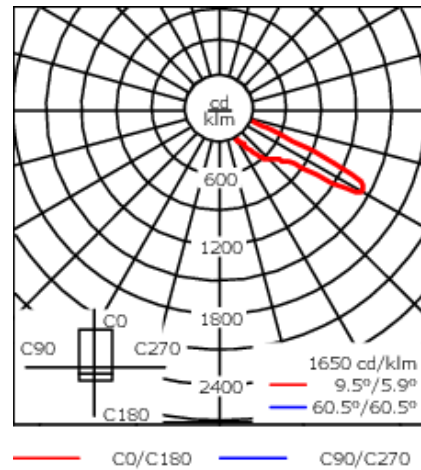

**Specifications**

**Material description**

Body	Marine-grade, die-cast aluminium alloy
Lens	Non-reflective safety glass lens
Colors	<ul style="list-style-type: none"> <li><span style="display: inline-block; width: 15px; height: 15px; background-color: black; margin-right: 5px;"></span> RAL9004 Black</li> <li><span style="display: inline-block; width: 15px; height: 15px; background-color: grey; margin-right: 5px;"></span> RAL9007 Grey Metallic</li> <li><span style="display: inline-block; width: 15px; height: 15px; background-color: white; margin-right: 5px;"></span> RAL9016 White</li> <li><span style="display: inline-block; width: 15px; height: 15px; background-color: darkgrey; margin-right: 5px;"></span> RAL8019 Dark Bronze</li> </ul>
Gasket	CCG® Controlled Compression Gasket
Fasteners	PCS Polymer Coated Stainless Steel Hardware
Ingress protection	IP66
Impact resistance	IK08
Corrosion resistance	5CE
Windage	1.57 ft <sup>2</sup>

**Electrical description**

Power supply	120V - 277V Universal Driver
Driver / Ballast	Integral EC electronic converter. 0-10V
Power factor	> 0.9
Surge protection	In-line bracket 10kV Surge Protector

**Additional information**

Lifetime	Ta=25°/40° L90B10 > 90000h
----------	----------------------------

## Mounting Accessories

### Bird deterrent

---

Description	Part ID
Bird deterrent BD	430-0015

---

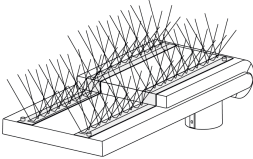

**AFL120 LED**

**Adaptor**

Description	Part ID
Adaptor AFL100	102-0392

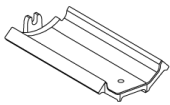

**Wall and pole brackets RE**

Description	Part ID	C1	D1	D2	D × L1	H1	M1	Weight (lb)
RE2-540 Pole bracket, double	111-0043	7.87			3 x 5	21.65		11.68

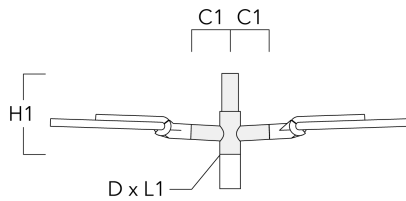

**AFL120 LED**

Description	Part ID	C1	D1	D2	D × L1	H1	M1	Weight (lb)
RE0-540 Wall bracket	111-0084	7.09	9.06	7.68			0.47	7.05



RE1-540 Pole bracket, single	111-0042	200			3 x 5	500		4.60
------------------------------	----------	-----	--	--	-------	-----	--	------



**AFL120 LED**

**Pole brackets RF**

Description	Part ID	C1	D × L1	H1	Weight (lb)
RF2-540 Pole bracket, double	111-0047	7.87	3 x 3	7.87	7.28



RF1-540 Pole bracket, single	111-0046	200	3 x 3	200	2.60
------------------------------	----------	-----	-------	-----	------



**Wall and pole brackets RX**

Description	Part ID	C1	D1	D2	D x L1	H1	H2	M1	M2	Weight (lb)
RX1-540 Pole bracket, single	111-0054	39.37			2.99 x 3.15	21.65				14.99



RX2-540 Pole bracket, double	111-0055	39.37			2.99 x 3.15	21.65				21.38
------------------------------	----------	-------	--	--	-------------	-------	--	--	--	-------



**AFL120 LED**

---

Description	Part ID	C1	D1	D2	D × L1	H1	H2	M1	M2	Weight (lb)
RX0-540 Wall bracket	111-0086	39.37	5.51	3.94		17.72	15.16	1.18	0.47	11.46

---



## Optical Accessories

### Backlight shield

Description	Part ID	Additional information
LS180	430-0029	Glare Shield for backlight spill. Glare Shield factory-installed or available as retrofit kit. Suitable for [S61][S65][S66][S70][S71][R60][R61][P66][Q66][A61] lenses. Must be specified at time of ordering.

