

102-0029

AFL120 LED

**we-ef**



**Description**

IP66, Class I or Class II. IK08. Marine-grade, die-cast aluminium alloy. 5CE superior corrosion protection including PCS hardware. CCG® Controlled Compression Gasket. Non-reflective flat safety glass cover, hinged. Integral EC electronic converter. CAD-optimised optics for superior illumination and glare control. OLC® One LED Concept. Factory installed LED circuit board. The luminaire is factory-sealed and does not need to be opened during installation. Can be used as post top or side entry version. Specification at time of order is recommended.

Spigot Ø 3" x 4"

Contact WE-EF direct or your local WE-EF sales representative for an individual solution designed to precisely meet your needs.

|                    |                              |
|--------------------|------------------------------|
| Weight             | 15.40 lb                     |
| Light distribution | [A61] Type IV Very Short     |
| Light source       | LED-24/24W / 350 mA - 4000 K |
| CRI                | 80                           |
| Power supply       | electronic gear              |
| LEDs               | 24                           |
| Rated input power  | 26.5 W                       |

**Nominal Lumen (lm)**

|             |      |
|-------------|------|
| LED Lumen   | 170  |
| Total Lumen | 4080 |
| Tj          | 85   |

**Rated lumens (lm)**

|             |        |
|-------------|--------|
| LED Lumen   | 153.2  |
| Total Lumen | 3677.3 |
| Ta          | 25     |

**WE-EF LIGHTING USA, LLC**

410-D Keystone Drive, 15086 Warrendale, PA 15086 - Phone: +1 724 742 0030  
customersupport.usa@we-ef.com - <https://we-ef.com/us>  
Subject to technical changes and errors. - Generated on 11/23/2024

102-0029

**we-ef**

**AFL120 LED**

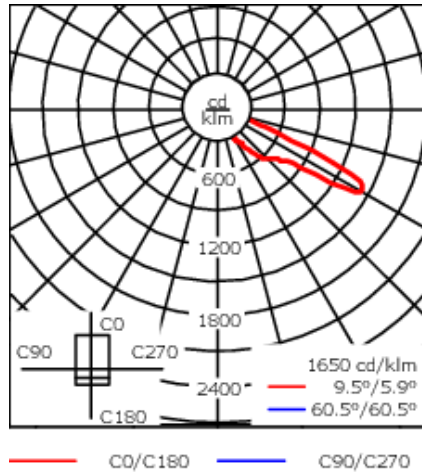
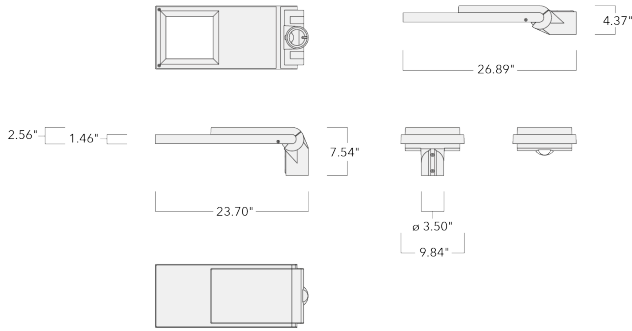

## Specifications

### Material description

|                      |  |
|----------------------|--|
| Body                 | Marine-grade, die-cast aluminium alloy   |
| Lens                 | Non-reflective safety glass lens   |
| Colors               | <ul style="list-style-type: none"> <li><span style="display: inline-block; width: 15px; height: 15px; background-color: black; margin-right: 5px;"></span> RAL9004 Black</li> <li><span style="display: inline-block; width: 15px; height: 15px; background-color: grey; margin-right: 5px;"></span> RAL9007 Grey Metallic</li> <li><span style="display: inline-block; width: 15px; height: 15px; background-color: white; margin-right: 5px;"></span> RAL9016 White</li> <li><span style="display: inline-block; width: 15px; height: 15px; background-color: darkgrey; margin-right: 5px;"></span> RAL8019 Dark Bronze</li> </ul> |
| Gasket               | CCG® Controlled Compression Gasket   |
| Fasteners            | PCS Polymer Coated Stainless Steel Hardware  |
| Ingress protection   | IP66   |
| Impact resistance    | IK08   |
| Corrosion resistance | 5CE  |
| Windage              | 1.57 ft <sup>2</sup>   |

### Electrical description

|                  |   |
|------------------|---|
| Power supply     | 120V - 277V Universal Driver            |
| Driver / Ballast | Integral EC electronic converter. 0-10V |
| Power factor     | > 0.9                                   |
| Surge protection | In-line bracket 10kV Surge Protector    |

### Additional information

|          |                            |
|----------|----------------------------|
| Lifetime | Ta=25°/40° L90B10 > 90000h |
|----------|----------------------------|

#### WE-EF LIGHTING USA, LLC

410-D Keystone Drive, 15086 Warrendale, PA 15086 - Phone: +1 724 742 0030

customersupport.usa@we-ef.com - <https://we-ef.com/us>

Subject to technical changes and errors. - Generated on 11/23/2024

**102-0029**

**we-ef**

**AFL120 LED**

## **Mounting Accessories**

### **Bird deterrent**

---

| Description       | Part ID  |
|-------------------|----------|
| Bird deterrent BD | 430-0015 |

---



---

#### **WE-EF LIGHTING USA, LLC**

410-D Keystone Drive, 15086 Warrendale, PA 15086 - Phone: +1 724 742 0030  
customersupport.usa@we-ef.com - <https://we-ef.com/us>  
Subject to technical changes and errors. - Generated on 11/23/2024

102-0029

**we-ef**

AFL120 LED

**Adaptor**

---

| Description    | Part ID  |
|----------------|----------|
| Adaptor AFL100 | 102-0392 |

---

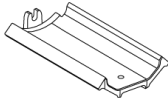

---

**Wall and pole brackets RE**

---

| Description                  | Part ID  | C1   | D1 | D2 | D x L1 | H1    | M1 | Weight (lb) |
|------------------------------|----------|------|----|----|--------|-------|----|-------------|
| RE2-540 Pole bracket, double | 111-0043 | 7.87 |    |    | 3 x 5  | 21.65 |    | 11.68       |

---

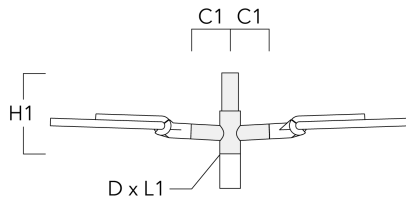

---

**WE-EF LIGHTING USA, LLC**

410-D Keystone Drive, 15086 Warrendale, PA 15086 - Phone: +1 724 742 0030

customersupport.usa@we-ef.com - <https://we-ef.com/us>

Subject to technical changes and errors. - Generated on 11/23/2024

**102-0029**  
**AFL120 LED**

| Description          | Part ID  | C1   | D1   | D2   | D × L1 | H1 | M1   | Weight (lb) |
|----------------------|----------|------|------|------|--------|----|------|-------------|
| RE0-540 Wall bracket | 111-0084 | 7.09 | 9.06 | 7.68 |        |    | 0.47 | 7.05        |



|                              |          |     |  |  |       |     |  |      |
|------------------------------|----------|-----|--|--|-------|-----|--|------|
| RE1-540 Pole bracket, single | 111-0042 | 200 |  |  | 3 x 5 | 500 |  | 4.60 |
|------------------------------|----------|-----|--|--|-------|-----|--|------|

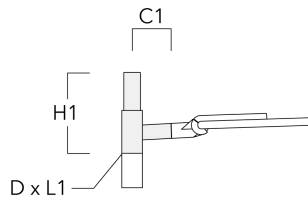

**WE-EF LIGHTING USA, LLC**

410-D Keystone Drive, 15086 Warrendale, PA 15086 - Phone: +1 724 742 0030  
 customersupport.usa@we-ef.com - <https://we-ef.com/us>  
 Subject to technical changes and errors. - Generated on 11/23/2024

**Pole brackets RF**

| Description                  | Part ID  | C1   | D x L1 | H1   | Weight (lb) |
|------------------------------|----------|------|--------|------|-------------|
| RF2-540 Pole bracket, double | 111-0047 | 7.87 | 3 x 3  | 7.87 | 7.28        |

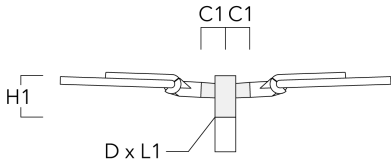

|                              |          |     |       |     |      |
|------------------------------|----------|-----|-------|-----|------|
| RF1-540 Pole bracket, single | 111-0046 | 200 | 3 x 3 | 200 | 2.60 |
|------------------------------|----------|-----|-------|-----|------|

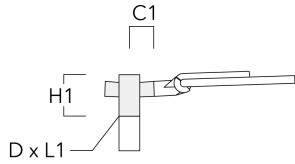

**WE-EF LIGHTING USA, LLC**

410-D Keystone Drive, 15086 Warrendale, PA 15086 - Phone: +1 724 742 0030

customersupport.usa@we-ef.com - <https://we-ef.com/us>

Subject to technical changes and errors. - Generated on 11/23/2024

**Wall and pole brackets RX**

| Description                  | Part ID  | C1    | D1 | D2 | D x L1      | H1    | H2 | M1 | M2 | Weight (lb) |
|------------------------------|----------|-------|----|----|-------------|-------|----|----|----|-------------|
| RX1-540 Pole bracket, single | 111-0054 | 39.37 |    |    | 2.99 x 3.15 | 21.65 |    |    |    | 14.99       |

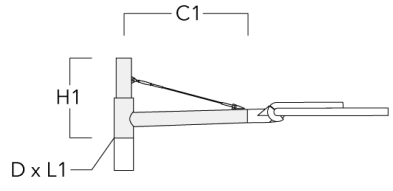

|                              |          |       |  |  |             |       |  |  |  |       |
|------------------------------|----------|-------|--|--|-------------|-------|--|--|--|-------|
| RX2-540 Pole bracket, double | 111-0055 | 39.37 |  |  | 2.99 x 3.15 | 21.65 |  |  |  | 21.38 |
|------------------------------|----------|-------|--|--|-------------|-------|--|--|--|-------|

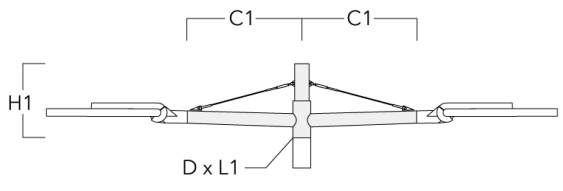

**WE-EF LIGHTING USA, LLC**

410-D Keystone Drive, 15086 Warrendale, PA 15086 - Phone: +1 724 742 0030

customersupport.usa@we-ef.com - <https://we-ef.com/us>

Subject to technical changes and errors. - Generated on 11/23/2024

**AFL120 LED**

| Description          | Part ID  | C1    | D1   | D2   | D × L1 | H1    | H2    | M1   | M2   | Weight (lb) |
|----------------------|----------|-------|------|------|--------|-------|-------|------|------|-------------|
| RX0-540 Wall bracket | 111-0086 | 39.37 | 5.51 | 3.94 |        | 17.72 | 15.16 | 1.18 | 0.47 | 11.46       |



**WE-EF LIGHTING USA, LLC**

410-D Keystone Drive, 15086 Warrendale, PA 15086 - Phone: +1 724 742 0030  
 customersupport.usa@we-ef.com - <https://we-ef.com/us>  
 Subject to technical changes and errors. - Generated on 11/23/2024



**102-0029**

**AFL120 LED**

**we-ef**

## Optical Accessories

### Backlight shield

| Description | Part ID  | Additional information  |
|-------------|----------|---|
| LS180       | 430-0029 | Glare Shield for backlight spill. Glare Shield factory-installed or available as retrofit kit. Suitable for [S61][S66][R61][P66][Q66][A61] lenses. Must be specified at time of ordering. |

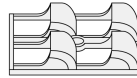

**WE-EF LIGHTING USA, LLC**

410-D Keystone Drive, 15086 Warrendale, PA 15086 - Phone: +1 724 742 0030  
customersupport.usa@we-ef.com - <https://we-ef.com/us>

Subject to technical changes and errors. - Generated on 11/23/2024