



#### Description

IP66. Class I / II. IK08. Marine-grade, die-cast aluminium alloy. 5CE superior corrosion protection + primer including PCS hardware. RFC™ Reflection Free Contour main lens. Silicone CCG® Controlled Compression Gasket. Luminaire is factory-sealed and does not need to be opened during installation.

Integral EC electronic converter. DALI. Advanced thermal management protects LEDs while optimising lumens output. LED board can be easily removed for upgrading. CAD- optimised OLC® optics for superior illumination and glare control. Optional 2200 K version up to max. 1050mA available. To be specified at time of ordering.

Maximum spacing for streetlighting applications depends on wattage and light distribution.

Please note that the luminaire requires a mounting bracket for installation. This bracket needs to be ordered separately. Please choose from one of our various options listed under Mounting Accessories

Weight	7.50 kg
Light distribution	asymmetric, side throw [S70]
Light source	LED-18/36W / 700 mA - 4000 K
CRI	80
Power supply	EC
LEDs	18
Rated input power	41 W

#### Nominal Lumen (lm)

LED Lumen	310
Total Lumen	5580
Tj	85

#### Rated lumens (lm)

LED Lumen	262.2
Total Lumen	4720.4
Ta	25

105-9806

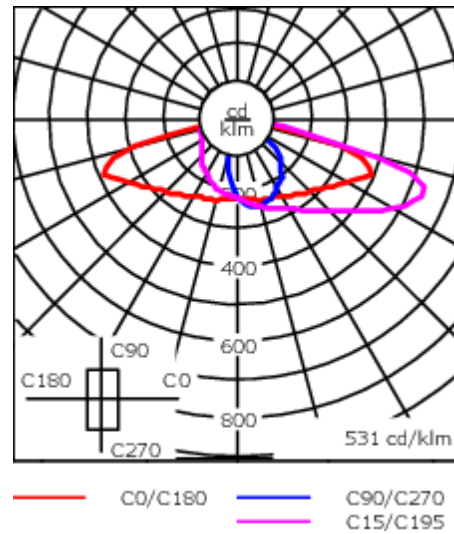
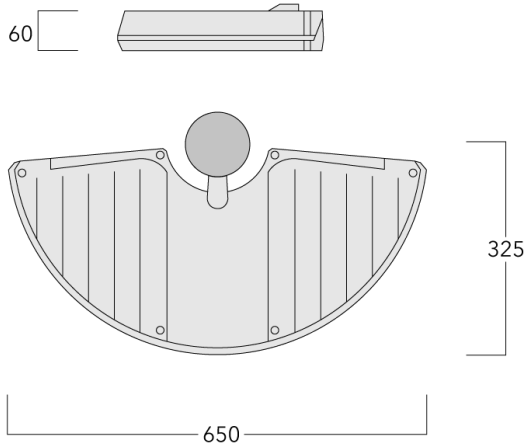

RMC320 LED

we-ef



## Specifications

### Material description

Body	Marine-grade, die-cast aluminium alloy
Lens	RFC® Reflection Free Contour technology
Colours	 RAL9004 Signal black  RAL9006 White aluminium  RAL9007 Grey aluminium
Gasket	Silicone CCG® Controlled Compression Gasket
Fasteners	PCS Polymer Coated Stainless Steel Hardware
Ingress protection	IP66
Impact resistance	IK08
Corrosion resistance	5CE+Primer

### Electrical description

Power supply	220-240V / 50-60 Hz
Driver / Ballast	Integral EC electronic converter. DALI
Power factor	> 0.9
Surge protection	In-pole surge protection SP10 device supplied. Please refer to WE-EF installation instructions for details. Use suffix +A for Integral surge protection.

### Additional information

Lifetime	Ta=40° L90B10 > 90000h
----------	------------------------

#### WE-EF LIGHTING Pty Ltd

47 Tarnard Drive, 3195 Braeside, Victoria - Phone: +61 3 8587 0444 - Fax: +61 3 8587 0499

info.australia@we-ef.com - <https://we-ef.com/aus>

Subject to technical changes and errors. - Generated on 05/10/2025

**Mounting Accessories**

**Wall and pole brackets RM**

Description	Part ID	C1	C2	C3	D1	D × L1	H1	H2	M1	Weight (kg)
RM1-76 Pole bracket, single	105-9849				114	76 x 80				1.20

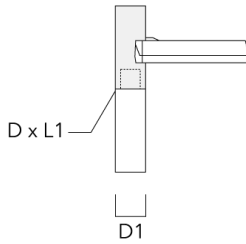

RM2-76 Pole bracket, double	105-9850				114	76 x 80				1.30
-----------------------------	----------	--	--	--	-----	---------	--	--	--	------

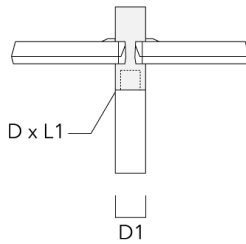

Description	Part ID	C1	C2	C3	D1	D × L1	H1	H2	M1	Weight (kg)
RM1-76 Pole bracket, single	105-9847				102	76 x 80				1.00

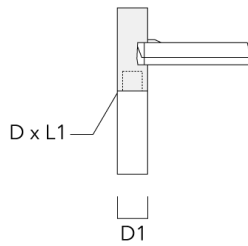

RM1-S Pole bracket, short	105-9845	50			≥ 76		150	124	11	0.60
---------------------------	----------	----	--	--	------	--	-----	-----	----	------

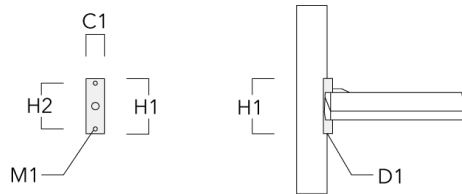

Description	Part ID	C1	C2	C3	D1	D × L1	H1	H2	M1	Weight (kg)
RM1-W Wall bracket, single	105-9846	375	105	80			175	155	6	1.30



RM2-76 Pole bracket, double	105-9848				102	76 x 80				1.00
-----------------------------	----------	--	--	--	-----	---------	--	--	--	------



**105-9806**

**RMC320 LED**

**we-ef**

## **Control**

### **Eco Step Dim® Basic**

Description	Part ID
Eco Step Dim® Basic LED	430-0001

### **Eco Step Dim® Advanced**

Description	Part ID
Eco Step Dim® Advanced LED	430-0002

### **R2C Ready to Connect**

Description	Part ID
R2C Ready to Connect (top)	430-0019

**WE-EF LIGHTING Pty Ltd**

47 Tarnard Drive, 3195 Braeside, Victoria - Phone: +61 3 8587 0444 - Fax: +61 3 8587 0499

info.australia@we-ef.com - <https://we-ef.com/aus>

Subject to technical changes and errors. - Generated on 05/10/2025

**105-9806**

**RMC320 LED**

**we-ef**

## **Optical Accessories**

### **Light shield**

Description	Part ID	Additional information
LS180-[A60]	003-4018	Glare Shield for backlight spill. Glare Shield factory-installed or available as retrofit kit. Suitable for [A60] lenses. Must be specified at time of ordering.
LS180	003-4019	Glare Shield for backlight spill. Glare Shield factory-installed or available as retrofit kit. Suitable for [S60], [S65], [S70], [R65], [P65] lenses. Must be specified at time of ordering.

**WE-EF LIGHTING Pty Ltd**

47 Tarnard Drive, 3195 Braeside, Victoria - Phone: +61 3 8587 0444 - Fax: +61 3 8587 0499

info.australia@we-ef.com - <https://we-ef.com/aus>

Subject to technical changes and errors. - Generated on 05/10/2025