

102-0179

AFL130 LED

**we-ef**



**Description**

IP66, Class I or Class II. IK08. Marine-grade, die-cast aluminium alloy. 5CE superior corrosion protection including PCS hardware. CCG® Controlled Compression Gasket. Non-reflective flat safety glass cover, hinged. Integral EC electronic converter. CAD-optimised optics for superior illumination and glare control. OLC® One LED Concept. Factory installed LED circuit board. The luminaire is factory-sealed and does not need to be opened during installation. Can be used as post top or side entry version. Specification at time of order is recommended.

Spigot Ø 3" x 4"

Contact WE-EF direct or your local WE-EF sales representative for an individual solution designed to precisely meet your needs.

For DarkSky compliant configurations of this product, please find the spec sheet and DarkSky certificate in the library.

Weight	19 lb
Light distribution	[A61] Type IV Very Short
Light source	LED-48/48W / 350 mA - 2200 K
CRI	70
Power supply	electronic gear
LEDs	48
Rated input power	52 W

**Nominal Lumen (lm)**

LED Lumen	145
Total Lumen	6960
Tj	85

**Rated lumens (lm)**

LED Lumen	127.1
Total Lumen	6099.6
Ta	25

**WE-EF LIGHTING USA, LLC**

410-D Keystone Drive, 15086 Warrendale, PA 15086 - Phone: +1 724 742 0030  
customersupport.usa@we-ef.com - <https://we-ef.com/us>  
Subject to technical changes and errors. - Generated on 11/23/2024

102-0179



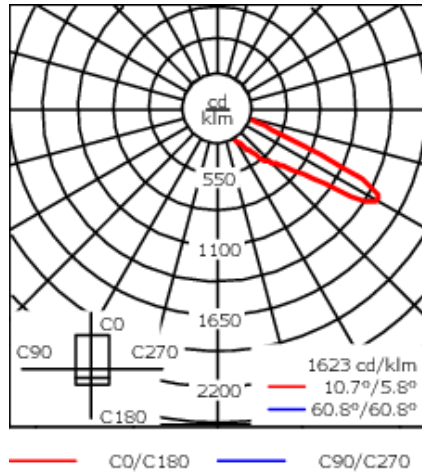
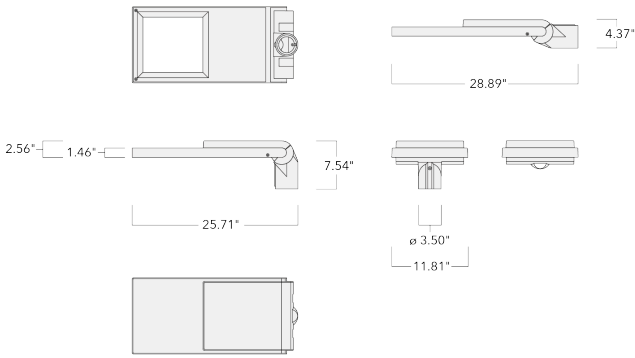

we-ef

AFL130 LED



## Specifications

### Material description

Body	Marine-grade, die-cast aluminium alloy
Lens	Non-reflective safety glass lens
Colors	<ul style="list-style-type: none"> <li> RAL9004 Black</li> <li> RAL9007 Grey Metallic</li> <li> RAL9016 White</li> <li> RAL8019 Dark Bronze</li> </ul>
Gasket	CCG® Controlled Compression Gasket
Fasteners	PCS Polymer Coated Stainless Steel Hardware
Ingress protection	IP66
Impact resistance	IK08
Corrosion resistance	5CE
Windage	0.1956 m <sup>2</sup>

### Electrical description

Driver / Ballast	Integral EC electronic converter. 0-10V
Power factor	> 0.9
Surge protection	6/6kV, optional 10kV

### Additional information

Lifetime	Ta=25°/40° L90B10 > 90000h
----------	----------------------------

#### WE-EF LIGHTING USA, LLC

410-D Keystone Drive, 15086 Warrendale, PA 15086 - Phone: +1 724 742 0030

customersupport.usa@we-ef.com - <https://we-ef.com/us>

Subject to technical changes and errors. - Generated on 11/23/2024

**102-0179**

**we-ef**

**AFL130 LED**

## Mounting Accessories

### Bird deterrent

---

Description	Part ID
Bird deterrent BD	430-0015

---

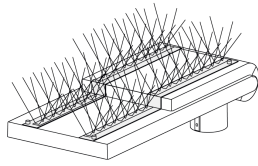

---

**WE-EF LIGHTING USA, LLC**

410-D Keystone Drive, 15086 Warrendale, PA 15086 - Phone: +1 724 742 0030  
customersupport.usa@we-ef.com - <https://we-ef.com/us>

Subject to technical changes and errors. - Generated on 11/23/2024

102-0179

AFL130 LED

**we-ef**

**Adaptor**

---

Description	Part ID
Adaptor AFL100	102-0392

---

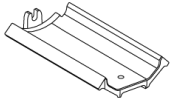

---

**Wall and pole brackets RE**

---

Description	Part ID	C1	D1	D2	D x L1	H1	M1	Weight (lb)
RE2-540 Pole bracket, double	111-0043	7.87			3 x 5	21.65		11.68

---

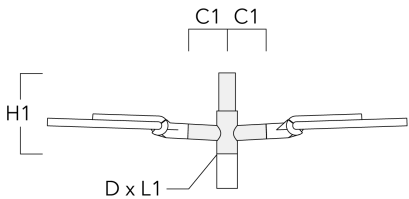

---

**WE-EF LIGHTING USA, LLC**

410-D Keystone Drive, 15086 Warrendale, PA 15086 - Phone: +1 724 742 0030  
customersupport.usa@we-ef.com - <https://we-ef.com/us>

Subject to technical changes and errors. - Generated on 11/23/2024

**102-0179**  
**AFL130 LED**

Description	Part ID	C1	D1	D2	D × L1	H1	M1	Weight (lb)
RE0-540 Wall bracket	111-0084	7.09	9.06	7.68			0.47	7.05

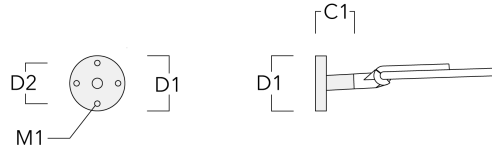

RE1-540 Pole bracket, single	111-0042	200			3 x 5	500		4.60
------------------------------	----------	-----	--	--	-------	-----	--	------

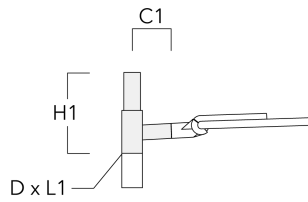

**WE-EF LIGHTING USA, LLC**

410-D Keystone Drive, 15086 Warrendale, PA 15086 - Phone: +1 724 742 0030  
 customersupport.usa@we-ef.com - <https://we-ef.com/us>  
 Subject to technical changes and errors. - Generated on 11/23/2024

**AFL130 LED**

**Pole brackets RF**

Description	Part ID	C1	D x L1	H1	Weight (lb)
RF2-540 Pole bracket, double	111-0047	7.87	3 x 3	7.87	7.28

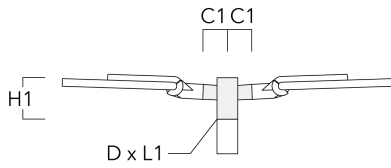

RF1-540 Pole bracket, single	111-0046	200	3 x 3	200	2.60
------------------------------	----------	-----	-------	-----	------

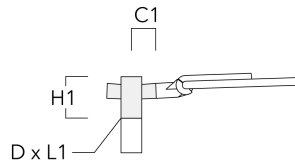

**WE-EF LIGHTING USA, LLC**

410-D Keystone Drive, 15086 Warrendale, PA 15086 - Phone: +1 724 742 0030

customersupport.usa@we-ef.com - <https://we-ef.com/us>

Subject to technical changes and errors. - Generated on 11/23/2024

**Wall and pole brackets RX**

Description	Part ID	C1	D1	D2	D x L1	H1	H2	M1	M2	Weight (lb)
RX1-540 Pole bracket, single	111-0054	39.37			2.99 x 3.15	21.65				14.99

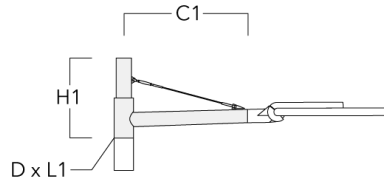

RX2-540 Pole bracket, double	111-0055	39.37			2.99 x 3.15	21.65				21.38
------------------------------	----------	-------	--	--	-------------	-------	--	--	--	-------

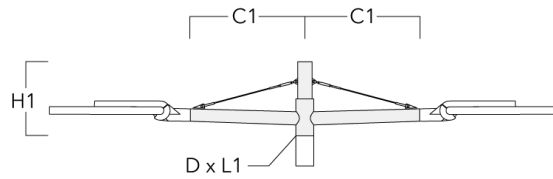

**WE-EF LIGHTING USA, LLC**

410-D Keystone Drive, 15086 Warrendale, PA 15086 - Phone: +1 724 742 0030

customersupport.usa@we-ef.com - <https://we-ef.com/us>

Subject to technical changes and errors. - Generated on 11/23/2024

**AFL130 LED**

Description	Part ID	C1	D1	D2	D × L1	H1	H2	M1	M2	Weight (lb)
RX0-540 Wall bracket	111-0086	39.37	5.51	3.94		17.72	15.16	1.18	0.47	11.46

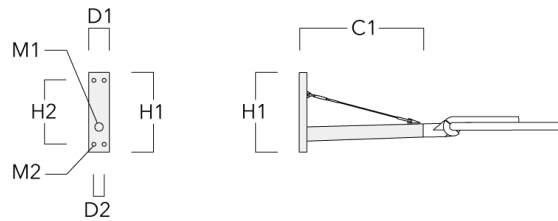

**WE-EF LIGHTING USA, LLC**

410-D Keystone Drive, 15086 Warrendale, PA 15086 - Phone: +1 724 742 0030  
 customersupport.usa@we-ef.com - <https://we-ef.com/us>  
 Subject to technical changes and errors. - Generated on 11/23/2024



**102-0179**

**AFL130 LED**

**we-ef**

## Optical Accessories

### Backlight shield

Description	Part ID	Additional information
LS180	430-0029	Glare Shield for backlight spill. Glare Shield factory-installed or available as retrofit kit. Suitable for [S61][S66][R61][P66][Q66][A61] lenses. Must be specified at time of ordering.

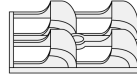

**WE-EF LIGHTING USA, LLC**

410-D Keystone Drive, 15086 Warrendale, PA 15086 - Phone: +1 724 742 0030  
customersupport.usa@we-ef.com - <https://we-ef.com/us>

Subject to technical changes and errors. - Generated on 11/23/2024