

102-0179

AFL130 LED

we-ef

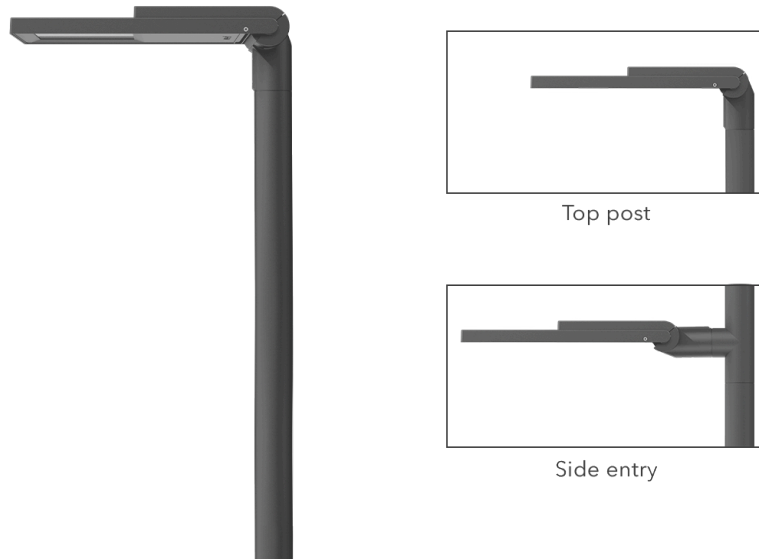

Description

IP66, Class I. IK08. Marine-grade, die-cast aluminium alloy. 5CE superior corrosion protection including PCS hardware. CCG® Controlled Compression Gasket. Non-reflective flat safety glass cover, hinged. Luminaire is factory-sealed and does not need to be opened during installation.

Integral EC electronic converter. DALI interface. CAD-optimised optics for superior illumination and glare control. OLC® One LED Concept.

Suitable for using as post top or side entry version. Recommend to be specified at time of ordering.

Optional spigot adaptor Ø 60 x 100 mm or 42 x 100 mm available; refer to accessory listings.

Weight	8.6 kg
Light distribution	asymmetric, forward throw [A61]
Light source	LED-48/48W / 350 mA - 2200 K
CRI	70
Power supply	EC
LEDs	48
Rated input power	52 W

Nominal Lumen (lm)

LED Lumen	145
Total Lumen	6960
Tj	85

Rated lumens (lm)

LED Lumen	127.1
Total Lumen	6099.6
Ta	25

WE-EF LIGHTING (Thailand) Co., Ltd.

57 Moo 5, Kingkaew Rd., Bangplee, 10540 Samutprakarn - Phone: +66 2 738 96 20 - Fax: +66 2 738 96 29

<https://we-ef.com/asia>

Subject to technical changes and errors. - Generated on 23/11/2024

102-0179



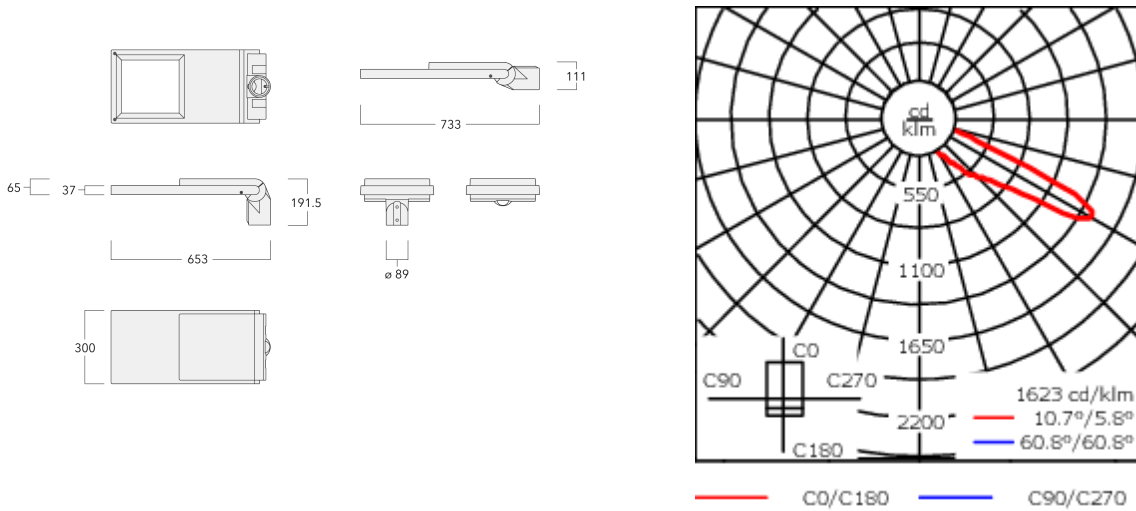

AFL130 LED

we-ef



Specifications

Material description

Body	Marine-grade, die-cast aluminium alloy
Lens	Non-reflective safety glass lens
Colours	 RAL9004 Signal black  RAL9007 Grey aluminium  RAL7016 Anthracite grey  RAL9016 Traffic white
Gasket	CCG® Controlled Compression Gasket
Fasteners	PCS Polymer Coated Stainless Steel Hardware
Ingress protection	IP66
Impact resistance	IK08
Corrosion resistance	5CE
Windage	0.1956 m ²

Electrical description

Driver / Ballast	Integral electronic converter with DALI interface
Power factor	> 0.9
Surge protection	6/6kV, optional 10kV

Additional information

Lifetime	Ta=25° L90B10 > 90000h
----------	------------------------

WE-EF LIGHTING (Thailand) Co., Ltd.

57 Moo 5, Kingkaew Rd., Bangplee, 10540 Samutprakarn - Phone: +66 2 738 96 20 - Fax: +66 2 738 96 29

<https://we-ef.com/asia>

Subject to technical changes and errors. - Generated on 23/11/2024

102-0179

AFL130 LED

we-ef

Control

Eco Step Dim

Description	Part ID
ECO Step Dim® Motion LED	400-0044
Eco Step Dim® Advanced LED	430-0002

R2C Ready to Connect

Description	Part ID
R2C Ready to Connect (top)	430-0019
R2C Ready to Connect (below)	430-0027
R2C Ready to Connect (top and below)	430-0032

WE-EF LIGHTING (Thailand) Co., Ltd.

57 Moo 5, Kingkaew Rd., Bangplee, 10540 Samutprakarn - Phone: +66 2 738 96 20 - Fax: +66 2 738 96 29

<https://we-ef.com/asia>

Subject to technical changes and errors. - Generated on 23/11/2024

102-0179

AFL130 LED

we-ef

Optical Accessories

Backlight shield

Description	Part ID	Additional information
Backlight shield LS180	102-0959-48LED	Glare Shield for backlight spill. Suitable for [S65] [R60] lenses. Glare Shield factory-installed or available as retrofit kit. Must be specified at time of ordering.



Backlight shield LS180	102-0395-48LED	Glare Shield for backlight spill. Suitable for [S61], [S66], [R61], [P66] [Q66], [A61] lenses. Glare Shield factory-installed or available as retrofit kit. Must be specified at time of ordering.
------------------------	----------------	-------------------------------------------------------------------------------------------------------------------------------------------------------------------------------------------------------



WE-EF LIGHTING (Thailand) Co., Ltd.

57 Moo 5, Kingkaew Rd., Bangplee, 10540 Samutprakarn - Phone: +66 2 738 96 20 - Fax: +66 2 738 96 29

<https://we-ef.com/asia>

Subject to technical changes and errors. - Generated on 23/11/2024

102-0179

AFL130 LED

we-ef

Mounting Accessories

Bird deterrent

Description	Part ID
Bird deterrent BD	430-0015



Adaptor

Description	Part ID
Adaptor AFL100	102-0392



WE-EF LIGHTING (Thailand) Co., Ltd.

57 Moo 5, Kingkaew Rd., Bangplee, 10540 Samutprakarn - Phone: +66 2 738 96 20 - Fax: +66 2 738 96 29

<https://we-ef.com/asia>

Subject to technical changes and errors. - Generated on 23/11/2024

Wall and pole brackets RE

Description	Part ID	C1	D1	D2	D × L1	H1	M1	Weight (kg)
Pole bracket RE2-540, double	111-0043	200			76 x 130	550		5.30



Wall bracket RE0-540	111-0084	180	230	195		12	3.20	
----------------------	----------	-----	-----	-----	--	----	------	--



AFL130 LED

Description	Part ID	C1	D1	D2	D × L1	H1	M1	Weight (kg)
RE1-540 Pole bracket, single	111-0042	200			76 x 130	500		4.60

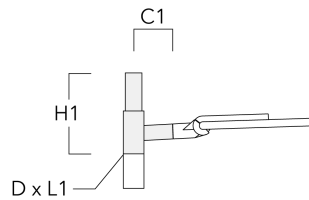

Pole brackets RF

Description	Part ID	C1	D × L1	H1	Weight (kg)
Pole bracket RF2-540, double	111-0047	200	76 x 80	200	3.30



AFL130 LED

Description	Part ID	C1	D × L1	H1	Weight (kg)
RF1-540 Pole bracket, single	111-0046	200	76 x 80	200	2.60



Wall and pole brackets RX

Description	Part ID	C1	D1	D2	D × L1	H1	H2	M1	M2	Weight (kg)
RX1-540 Pole bracket, single	111-0054	1000			76 x 130	550				6.8

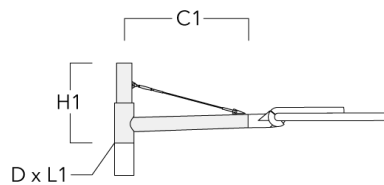

AFL130 LED

Description	Part ID	C1	D1	D2	D × L1	H1	H2	M1	M2	Weight (kg)
RX2-540 Pole bracket, double	111-0055	1000			76 x 130	550				9.70



RX0-540 Wall bracket	111-0086	1000	140	100		450	385	30	12	5.20
----------------------	----------	------	-----	-----	--	-----	-----	----	----	------

