

102-0289

AFL130-WL LED

we-ef



Description

Wild-Light. IP66, Class I or Class II. IK08. Marine-grade, die-cast aluminium alloy. 5CE superior corrosion protection including PCS hardware. CCG® Controlled Compression Gasket. Non-reflecting flat safety glass cover, hinged. Integral EC electronic converter in thermally separated compartment. CAD-optimised optics for superior illumination and glare control. OLC® One LED Concept. Factory installed LED circuit board. Wild-Light with Advanced or Motion available on request, must be specified at time of ordering. For further details and available variants see below under additional information - Wild-Light Presentation. The luminaire is factory-sealed and does not need to be opened during installation. Can be used as post top or side entry version. Specification at time of order is recommended.

Spigot Ø 76 x 100 mm. Spigot Ø 60 x 100 mm or 42 x 100 mm optional available. Must be indicated during order placement.

Contact WE-EF direct or your local WE-EF sales representative for an individual solution designed to precisely meet your needs.

IMPORTANT

Photometric data legend (for ies-data):

WE-EF LEUCHTEN GmbH

Töpinger Straße 16, 29646 Bispingen, Germany - Phone: +49 5194 909-0
info@we-ef.com - <https://we-ef.com>

Subject to technical changes and errors. - Generated on 23/11/2024

| | |
|--------------------|-----------------------------------|
| Weight | 8.60 kg |
| Light distribution | asymmetric, side throw beam [S61] |
| Light source | LED-8-40/16W-80W/2200K-3000K |
| CRI | 70/80 |
| Power supply | EC |
| LEDs | 48 |
| Rated input power | 104 W |

Nominal Lumen (lm)

| | |
|-------------|-------|
| LED Lumen | 286.7 |
| Total Lumen | 13760 |
| Tj | 85 |

Rated lumens (lm)

| | |
|-------------|---------|
| LED Lumen | 268 |
| Total Lumen | 12863.4 |
| Ta | 25 |

102-0289

AFL130-WL LED

we-ef

Part ID (channel I+II - both colour temperatures 1850K (True Amber) + 2200K / 2200K + 3000K)

Part ID_1 (channel I - lower colour temperature 1850K (True Amber) / 2200K only)

Part ID_2 (channel II - upper colour temperature 2200K / 3000K only)

Photometric data legend (for ldt-data):

Part ID (channel I+II - both colour temperatures 1850K (True Amber) + 2200K / 2200K + 3000K)

Part ID (channel I - lower colour temperature 1850K (True Amber) / 2200K only)

Part ID (channel II - upper colour temperature 2200K / 3000K only)

Photometric files (IES, LDT) for light distributions [S61] [S65] [S66] [S70] [R60] [R61] [P66] [Q66] [A61] with Backlight Shield on request.

WE-EF LEUCHTEN GmbH

Töpinger Straße 16, 29646 Bispingen, Germany - Phone: +49 5194 909-0
info@we-ef.com - <https://we-ef.com>

Subject to technical changes and errors. - Generated on 23/11/2024

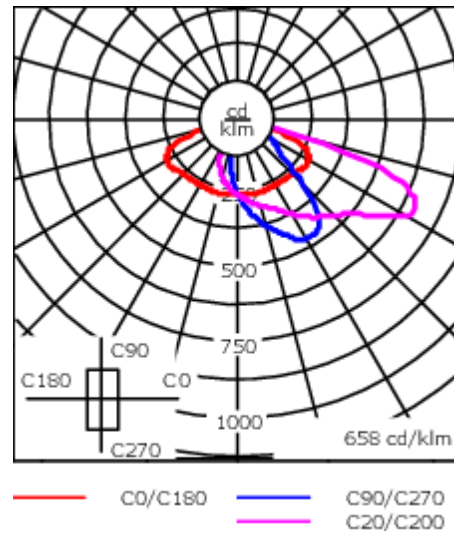
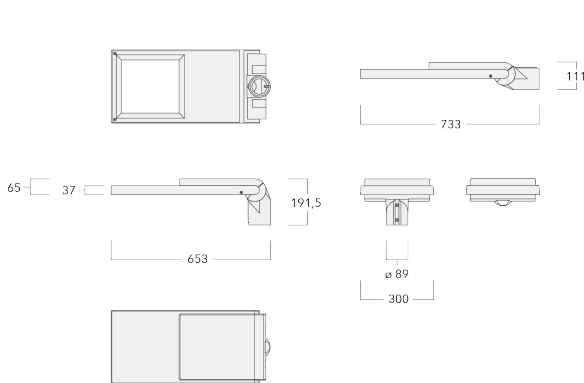

Specifications

Material description

| | |
|----------------------|--|
| Body | Marine-grade, die-cast aluminium alloy |
| Lens | Non-reflective safety glass lens |
| Colours | <div style="display: flex; align-items: center; gap: 10px;"> <div style="width: 20px; height: 15px; background-color: black; margin-right: 5px;"></div> RAL9004 Signal black </div> <div style="display: flex; align-items: center; gap: 10px;"> <div style="width: 20px; height: 15px; background-color: #cccccc; margin-right: 5px;"></div> RAL9006 White aluminium </div> <div style="display: flex; align-items: center; gap: 10px;"> <div style="width: 20px; height: 15px; background-color: #808080; margin-right: 5px;"></div> RAL9007 Grey aluminium </div> <div style="display: flex; align-items: center; gap: 10px;"> <div style="width: 20px; height: 15px; background-color: #333333; margin-right: 5px;"></div> RAL7016 Anthracite grey </div> <div style="display: flex; align-items: center; gap: 10px;"> <div style="width: 20px; height: 15px; background-color: #e0e0e0; margin-right: 5px;"></div> RAL9016 Traffic white </div> |
| Gasket | CCG® Controlled Compression Gasket |
| Fasteners | PCS Polymer Coated Stainless Steel Hardware |
| Ingress protection | IP66 |
| Impact resistance | IK08 |
| Corrosion resistance | 5CE |
| Windage | 0.1956 m ² |

Electrical description

| | |
|------------------|--|
| Power supply | 220-240V / 50-60 Hz |
| Driver / Ballast | Integral EC electronic converter. DALI |
| Power factor | > 0.9 |
| Surge protection | 6/6kV, optional 10kV |

Additional information

| | |
|-------------------------|------------------------|
| Lifetime | Ta=25° L90B10 > 90000h |
| Energy efficiency class | F-G (Light source) |

WE-EF LEUCHTEN GmbH

Töpinger Straße 16, 29646 Bispingen, Germany - Phone: +49 5194 909-0
 info@we-ef.com - <https://we-ef.com>

Subject to technical changes and errors. - Generated on 23/11/2024

Control

R2C Ready to Connect

| Description | Part ID |
|--------------------------------------|----------|
| R2C Ready to Connect (top) | 430-0019 |
| R2C Ready to Connect (below) | 430-0027 |
| R2C Ready to Connect (top and below) | 430-0032 |

Wild-Light Citygrid Motion On Pole

| Description | Part ID | Additional information |
|--|----------|---|
| Wild-Light Citygrid Motion - Entry- Package | 420-0111 | Citygrid Motion On Pole Controller for Wild-Light. The Citygrid Motion On Pole Controller is the all-in-one device that can convert existing luminaires into an intelligent lighting system. |

The entry-level package:

WE-EF supplies and configures luminaires and the Citygrid system once ex works or on site. Reconfiguration is available as a service (chargeable). Gateway/app not included.

Applications: individual communal projects, isolated solutions and field trials for smart lighting, e.g. single streets, paths or squares. Semi-public or private projects, e.g. company site, car park.



AFL130-WL LED

| Description | Part ID | Additional information |
|---|----------|---|
| Wild-Light Citygrid Motion - Standalone-Package | 420-0112 | <p>Citygrid Motion On Pole Controller for Wild-Light.</p> <p>The Citygrid Motion On Pole Controller is the all-in-one device that can convert existing luminaires into an intelligent lighting system.</p> <p>The standalone package: Dongle & apps included; operators can configure, change and service the Citygrid system themselves (on site) using the apps on their mobile device.</p> <p>Applications: demarcated communal projects (street, square, district) or private projects (larger company sites, commercial estates) if qualified personnel are available for the operation of the system.</p> |



AFL130-WL LED

| Description | Part ID | Additional information |
|---|----------|--|
| Wild-Light Citygrid Motion - Smart-City-Package | 420-0113 | <p>Citygrid Motion On Pole Controller for Wild-Light. The Citygrid Motion On Pole Controller is the all-in-one device that can convert existing luminaires into an intelligent lighting system.</p> <p>The Smart-City package: Internet gateway (via mobile phone) and dashboard included; operators can configure, change and service themselves (remotely). Networked Smart-City functions (data collection, remote maintenance, etc.). Applications: larger communal projects or field trials in the context of Smart City; operator has qualified personnel (municipal utilities).</p> |



Wild-Light Eco Step Dim® Advanced

| Description | Part ID | Additional information |
|-----------------------------------|----------|--|
| Wild-Light Eco Step Dim® Advanced | 420-2410 | <p>Fully automatic independent dimming pre-set, without additional installation effort for Wild-Light. Example: Starting the night with warm white (3000 K from 20:00 to 22:00), reduced to biodiversity friendly in the heart of the night (2200 K from 22:00 to 06:00), and returning back to warm white in the early morning (3000 K from 06:00 to 07:00).</p> <p>This is the easiest to implement solution to create a nature-friendly lighting scenario, as no additional installations or external controls are needed. All pre-settings are made in the two LED drivers. The dimming values are programmed into the driver during the production of the luminaires. An optional link with sunrise and sunset times can mean additional optimisation. A customer-specific configuration is possible.</p> <p>The settings can be changed directly on the LED driver at any time (NFC). The necessary tool is standardised and can also be obtained from WE-EF as an optional extra.</p> |

Wild-Light Citygrid Motion On Luminaire

| Description | Part ID | Additional information |
|--|----------|--|
| Wild-Light Citygrid Motion - Entry- Package | 420-0121 | <p>Citygrid Motion built-in light controller with angled sensors for Wild-Light. The sensors detect motion and traffic on entering the sensor and lighting field.</p> <p>The entry-level package: WE-EF supplies and configures luminaires and the Citygrid system once ex works or on site. Reconfiguration is available as a service (chargeable). Gateway/app not included.</p> <p>Applications: individual communal projects, isolated solutions and field trials for smart lighting, e.g. single streets, paths or squares. Semi-public or private projects, e.g. company site, car park.</p> |

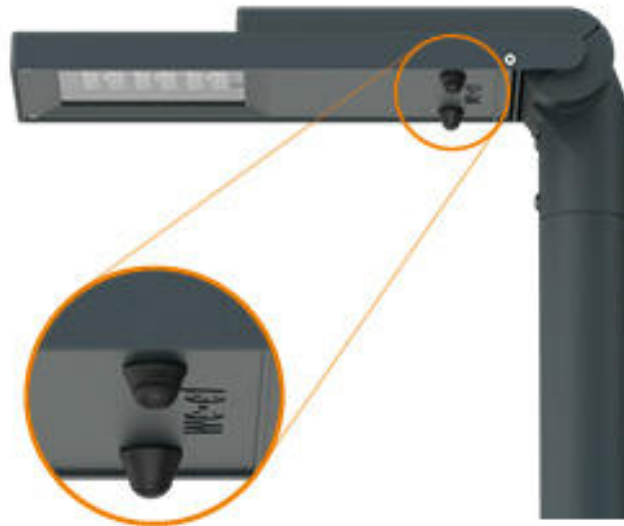

AFL130-WL LED

| Description | Part ID | Additional information |
|---|----------|---|
| Wild-Light Citygrid Motion - Standalone-Package | 420-0122 | <p>Citygrid Motion built-in light controller with angled sensors for Wild-Light. The sensors detect motion and traffic on entering the sensor and lighting field.</p> <p>The standalone package: Dongle & apps included; operators can configure, change and service the Citygrid system themselves (on site) using the apps on their mobile device. Applications: demarcated communal projects (street, square, district) or private projects (larger company sites, commercial estates) if qualified personnel are available for the operation of the system.</p> |

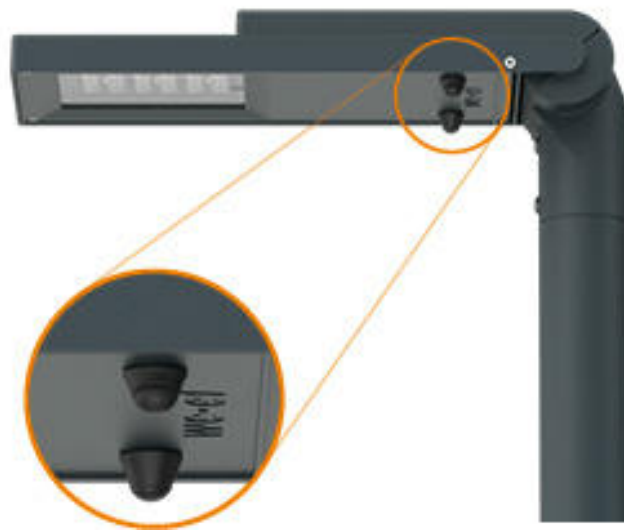

AFL130-WL LED

| Description | Part ID | Additional information |
|---|----------|--|
| Wild-Light Citygrid Motion - Smart-City-Package | 420-0123 | <p>Citygrid Motion built-in light controller with angled sensors for Wild-Light. The sensors detect motion and traffic on entering the sensor and lighting field.</p> <p>The Smart-City package: Internet gateway (via mobile phone) and dashboard included; operators can configure, change and service themselves (remotely). Networked Smart-City functions (data collection, remote maintenance, etc.). Applications: larger communal projects or field trials in the context of Smart City; operator has qualified personnel (municipal utilities).</p> |

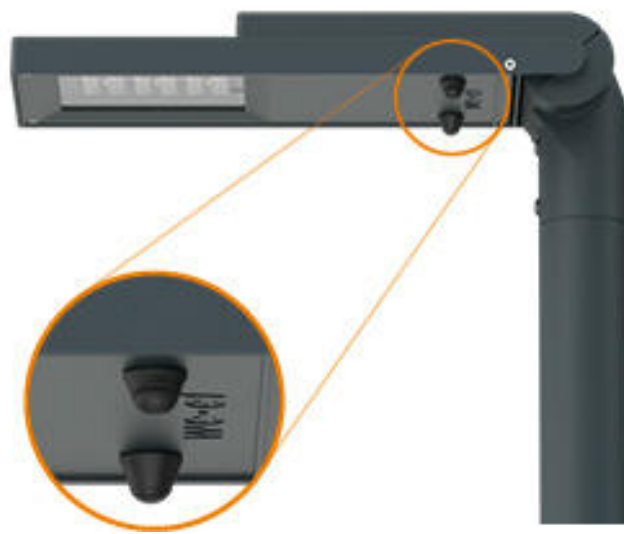

Wild-Light Citygrid Motion Zhaga

| Description | Part ID | Additional information |
|--|----------|---|
| Wild-Light Citygrid Motion - Entry-Package | 420-0132 | <p>Citygrid Motion Zhaga controller with sensor for Wild-Light. The compact all-in-one design turns every luminaire with a Zhaga Book 18 socket facing the street surface into motion-controlled, intelligent street & area lighting.</p> <p>The entry-level package: WE-EF supplies and configures luminaires and the Citygrid system once ex works or on site. Reconfiguration is available as a service (chargeable). Gateway/app not included.</p> <p>Applications: individual communal projects, isolated solutions and field trials for smart lighting, e.g. single streets, paths or squares. Semi-public or private projects, e.g. company site, car park.</p> |

AFL130-WL LED

| Description | Part ID | Additional information |
|---|----------|---|
| Wild-Light Citygrid Motion - Standalone-Package | 420-0131 | <p>Citygrid Motion Zhaga controller with sensor for Wild-Light. The compact all-in-one design turns every luminaire with a Zhaga Book 18 socket facing the street surface into motion-controlled, intelligent street & area lighting.</p> <p>The standalone package: Dongle & apps included; operators can configure, change and service the Citygrid system themselves (on site) using the apps on their mobile device. Applications: demarcated communal projects (street, square, district) or private projects (larger company sites, commercial estates) if qualified personnel are available for the operation of the system.</p> |



AFL130-WL LED

| Description | Part ID | Additional information |
|---|----------|---|
| Wild-Light Citygrid Motion - Smart-City-Package | 420-0133 | <p>Citygrid Zhaga controller with sensor for Wild-Light. The compact all-in-one design turns every luminaire with a Zhaga Book 18 socket facing the street surface into motion-controlled, intelligent street & area lighting.</p> <p>The Smart-City package: Internet gateway (via mobile phone) and dashboard included; operators can configure, change and service themselves (remotely). Networked Smart-City functions (data collection, remote maintenance, etc.). Applications: larger communal projects or field trials in the context of Smart City; operator has qualified personnel (municipal utilities).</p> |



102-0289

AFL130-WL LED

we-ef

Mounting Accessories

Bird deterrent

| Description | Part ID |
|-------------------|----------|
| Bird deterrent BD | 430-0015 |



Adaptor

| Description | Part ID |
|----------------|----------|
| Adaptor AFL100 | 102-0392 |

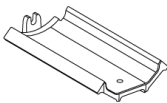

WE-EF LEUCHTEN GmbH

Töpinger Straße 16, 29646 Bispingen, Germany - Phone: +49 5194 909-0
info@we-ef.com - <https://we-ef.com>

Subject to technical changes and errors. - Generated on 23/11/2024

Wall and pole brackets RE

| Description | Part ID | C1 | D1 | D2 | D × L1 | H1 | M1 | Weight (kg) |
|------------------------------|----------|-----|----|----|----------|-----|----|-------------|
| RE2-540 Pole bracket, double | 111-0043 | 200 | | | 76 x 130 | 550 | | 5.30 |

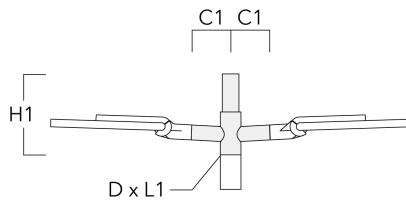

| | | | | | | | | |
|----------------------|----------|-----|-----|-----|--|----|------|--|
| RE0-540 Wall bracket | 111-0084 | 180 | 230 | 195 | | 12 | 3.20 | |
|----------------------|----------|-----|-----|-----|--|----|------|--|

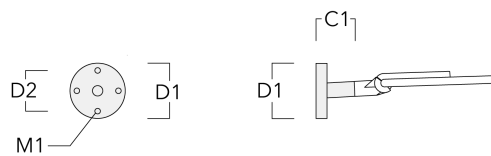

AFL130-WL LED

| Description | Part ID | C1 | D1 | D2 | D × L1 | H1 | M1 | Weight (kg) |
|------------------------------|----------|-----|----|----|----------|-----|----|-------------|
| RE1-540 Pole bracket, single | 111-0042 | 200 | | | 76 x 130 | 500 | | 4.60 |

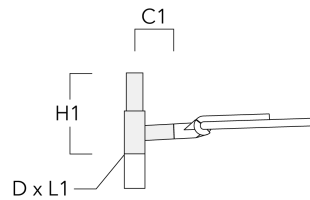

Pole brackets RF

| Description | Part ID | C1 | D × L1 | H1 | Weight (kg) |
|------------------------------|----------|-----|---------|-----|-------------|
| RF2-540 Pole bracket, double | 111-0047 | 200 | 76 x 80 | 200 | 3.30 |

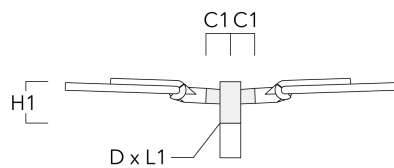

AFL130-WL LED

| Description | Part ID | C1 | D × L1 | H1 | Weight (kg) |
|------------------------------|----------|-----|---------|-----|-------------|
| RF1-540 Pole bracket, single | 111-0046 | 200 | 76 x 80 | 200 | 2.60 |



Wall and pole brackets RX

| Description | Part ID | C1 | D1 | D2 | D × L1 | H1 | H2 | M1 | M2 | Weight (kg) |
|------------------------------|----------|------|----|----|----------|-----|----|----|----|-------------|
| RX1-540 Pole bracket, single | 111-0054 | 1000 | | | 76 x 130 | 550 | | | | 6.8 |

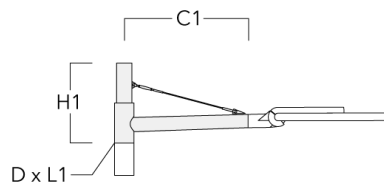

AFL130-WL LED

| Description | Part ID | C1 | D1 | D2 | D × L1 | H1 | H2 | M1 | M2 | Weight (kg) |
|------------------------------|----------|------|----|----|----------|-----|----|----|----|-------------|
| RX2-540 Pole bracket, double | 111-0055 | 1000 | | | 76 x 130 | 550 | | | | 9.70 |



| | | | | | | | | | | |
|----------------------|----------|------|-----|-----|--|-----|-----|----|----|------|
| RX0-540 Wall bracket | 111-0086 | 1000 | 140 | 100 | | 450 | 385 | 30 | 12 | 5.20 |
|----------------------|----------|------|-----|-----|--|-----|-----|----|----|------|



102-0289

AFL130-WL LED

we-ef

Optical Accessories

Backlight shield

| Description | Part ID | Additional information |
|-------------|----------|---|
| LS180 | 430-0029 | Glare Shield for backlight spill. Glare Shield factory-installed or available as retrofit kit. Suitable for [S61][S66][R61][P66][Q66][A61] lenses. Must be specified at time of ordering. |

