

102-0290

AFL130-WL LED

we-ef



Description

Wild-Light. IP66, Class I or Class II. IK08. Marine-grade, die-cast aluminium alloy. 5CE superior corrosion protection including PCS hardware. CCG® Controlled Compression Gasket. Non-reflecting flat safety glass cover, hinged. Integral EC electronic converter in thermally separated compartment. CAD-optimised optics for superior illumination and glare control. OLC® One LED Concept. Factory installed LED circuit board. Wild-Light with Advanced or Motion available on request, must be specified at time of ordering. For further details and available variants see below under additional information - Wild-Light Presentation. The luminaire is factory-sealed and does not need to be opened during installation. Can be used as post top or side entry version. Specification at time of order is recommended.

Spigot Ø 76 x 100 mm. Spigot Ø 60 x 100 mm or 42 x 100 mm optional available. Must be indicated during order placement.

Contact WE-EF direct or your local WE-EF sales representative for an individual solution designed to precisely meet your needs.

IMPORTANT

Photometric data legend (for ies-data):

WE-EF LIGHTING Pty Ltd

6/13 Downard Street, 3195 Braeside, Victoria - Phone: +61 3 8587 0444 - Fax: +61 3 8587 0499

info.australia@we-ef.com - <https://we-ef.com/aus>

Subject to technical changes and errors. - Generated on 23/10/2024

| | |
|---------------------------|------------------------------------|
| Weight | 8.60 kg |
| Light distribution | asymmetric, side throw [S61] |
| Light source | LED-16-32/16W-64W/True Amber-2200K |
| CRI | NA/70 |
| Power supply | EC |
| LEDs | 48 |
| Rated input power | 83 W |
| Nominal Lumen (lm) | |
| LED Lumen | 193.3 |
| Total Lumen | 9280 |
| Tj | 85 |
| Rated lumens (lm) | |
| LED Lumen | 180.7 |
| Total Lumen | 8675.3 |
| Ta | 25 |

102-0290

AFL130-WL LED

we-ef

Part ID (channel I+II - both colour temperatures 1850K (PC Amber) + 2200K / 2200K + 3000K)

Part ID_1 (channel I - lower colour temperature 1850K (PC Amber) / 2200K only)

Part ID_2 (channel II - upper colour temperature 2200K / 3000K only)

Photometric data legend (for ldt-data):

Part ID (channel I+II - both colour temperatures 1850K (PC Amber) + 2200K / 2200K + 3000K)

Part ID (channel I - lower colour temperature 1850K (PC Amber) / 2200K only)

Part ID (channel II - upper colour temperature 2200K / 3000K only)

Photometric files (IES, LDT) for light distributions [S61] [S65] [S66] [S70] [R60] [R61] [P66] [Q66] [A61] with Back-light Shield on request.

WE-EF LIGHTING Pty Ltd

6/13 Downard Street, 3195 Braeside, Victoria - Phone: +61 3 8587 0444 - Fax: +61 3 8587 0499

info.australia@we-ef.com - <https://we-ef.com/aus>

Subject to technical changes and errors. - Generated on 23/10/2024

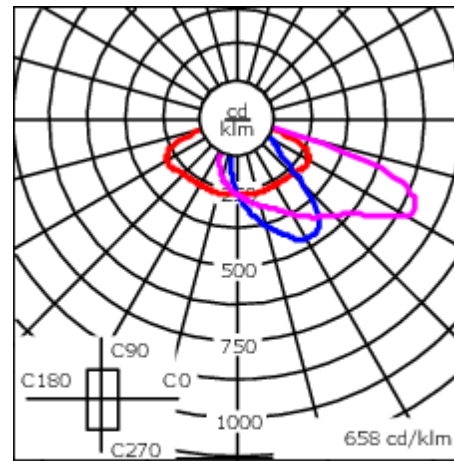
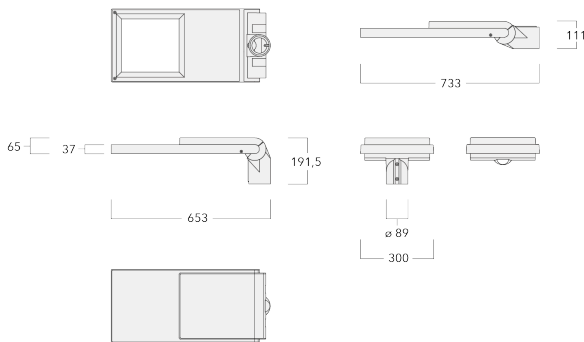

— C0/C180 — C90/C270
— C20/C200

Specifications

Material description

| | |
|----------------------|--|
| Body | Marine-grade, die-cast aluminium alloy |
| Lens | Non-reflective safety glass lens |
| Colours | <div style="display: flex; align-items: center;"> <div style="width: 20px; height: 15px; background-color: black; margin-right: 5px;"></div> RAL9004 Signal black </div> <div style="display: flex; align-items: center; margin-top: 5px;"> <div style="width: 20px; height: 15px; background-color: #cccccc; margin-right: 5px;"></div> RAL9006 White aluminium </div> <div style="display: flex; align-items: center; margin-top: 5px;"> <div style="width: 20px; height: 15px; background-color: #808080; margin-right: 5px;"></div> RAL9007 Grey aluminium </div> |
| Gasket | CCG® Controlled Compression Gasket |
| Fasteners | PCS Polymer Coated Stainless Steel Hardware |
| Ingress protection | IP66 |
| Impact resistance | IK08 |
| Corrosion resistance | 5CE |
| Windage | 0.1956 m ² |

Electrical description

| | |
|------------------|--|
| Driver / Ballast | Integral EC electronic converter. DALI |
| Power factor | > 0.9 |
| Surge protection | In-pole surge protection SP10 device supplied. Please refer to WE-EF installation instructions for details. Use suffix +A for Integral surge protection. |

Additional information

| | |
|----------|------------------------|
| Lifetime | Ta=40° L90B10 > 90000h |
|----------|------------------------|

WE-EF LIGHTING Pty Ltd

6/13 Downard Street, 3195 Braeside, Victoria - Phone: +61 3 8587 0444 - Fax: +61 3 8587 0499

info.australia@we-ef.com - <https://we-ef.com/aus>

Subject to technical changes and errors. - Generated on 23/10/2024

102-0290

AFL130-WL LED

we-ef

Control

R2C Ready to Connect

| Description | Part ID |
|--------------------------------------|----------|
| R2C Ready to Connect (top) | 430-0019 |
| R2C Ready to Connect (below) | 430-0027 |
| R2C Ready to Connect (top and below) | 430-0032 |

WE-EF LIGHTING Pty Ltd

6/13 Downard Street, 3195 Braeside, Victoria - Phone: +61 3 8587 0444 - Fax: +61 3 8587 0499

info.australia@we-ef.com - <https://we-ef.com/aus>

Subject to technical changes and errors. - Generated on 23/10/2024

102-0290

AFL130-WL LED

we-ef

Mounting Accessories

Bird deterrent

| Description | Part ID |
|-------------------|----------|
| Bird deterrent BD | 430-0015 |



Adaptor

| Description | Part ID |
|----------------|----------|
| Adaptor AFL100 | 102-0392 |



Wall and pole brackets RE

WE-EF LIGHTING Pty Ltd

6/13 Downard Street, 3195 Braeside, Victoria - Phone: +61 3 8587 0444 - Fax: +61 3 8587 0499

info.australia@we-ef.com - <https://we-ef.com/aus>

Subject to technical changes and errors. - Generated on 23/10/2024

AFL130-WL LED

| Description | Part ID | Additional information | C1 | D1 | D2 | D × L1 | H1 | M1 | Weight (kg) |
|------------------------------|----------|------------------------|-----|----|----|----------|-----|----|-------------|
| RE2-540 Pole bracket, double | 111-0043 | | 200 | | | 76 x 130 | 550 | | 5.30 |

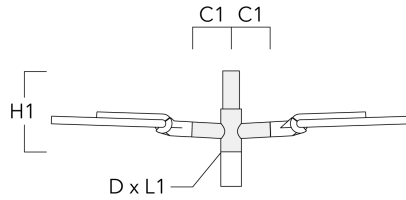

| | | | | | | | | | |
|----------------------|----------|--|-----|-----|-----|--|--|----|------|
| RE0-540 Wall bracket | 111-0084 | | 180 | 230 | 195 | | | 12 | 3.20 |
|----------------------|----------|--|-----|-----|-----|--|--|----|------|

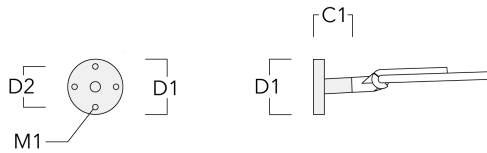

AFL130-WL LED

| Description | Part ID | Additional information | C1 | D1 | D2 | D × L1 | H1 | M1 | Weight (kg) |
|--|----------|--|-----|----|----|---------|-----|----|-------------|
| Pole bracket RE1, single for mounting on AML-A poles | 111-9022 | Mounting brackets. Marine-grade aluminium alloy. 5CE superior corrosion protection including PCS hardware. | 320 | | | 76 x 76 | 550 | | 6.10 |



| | | | | | | | | | |
|--|----------|--|-----|--|--|---------|-----|--|------|
| Pole bracket RE2, double for mounting on AML-A poles | 111-9023 | Mounting brackets. Marine-grade aluminium alloy. 5CE superior corrosion protection including PCS hardware. | 320 | | | 76 x 76 | 550 | | 7.20 |
|--|----------|--|-----|--|--|---------|-----|--|------|



AFL130-WL LED

| Description | Part ID | Additional information | C1 | D1 | D2 | D × L1 | H1 | M1 | Weight (kg) |
|------------------------------|----------|------------------------|-----|----|----|----------|-----|----|-------------|
| RE1-540 Pole bracket, single | 111-0042 | | 200 | | | 76 x 130 | 500 | | 4.60 |

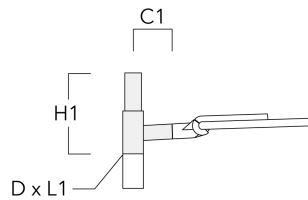

Pole brackets RF

| Description | Part ID | C1 | D × L1 | H1 | Weight (kg) |
|------------------------------|----------|-----|---------|-----|-------------|
| RF2-540 Pole bracket, double | 111-0047 | 200 | 76 x 80 | 200 | 3.30 |

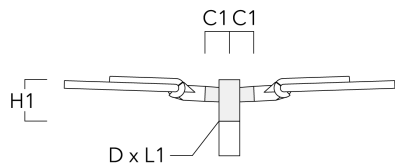

AFL130-WL LED

| Description | Part ID | C1 | D × L1 | H1 | Weight (kg) |
|------------------------------|----------|-----|---------|-----|-------------|
| RF1-540 Pole bracket, single | 111-0046 | 200 | 76 x 80 | 200 | 2.60 |

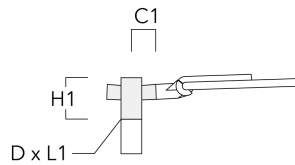

Wall and pole brackets RX

| Description | Part ID | C1 | D1 | D2 | D × L1 | H1 | H2 | M1 | M2 | Weight (kg) |
|------------------------------|----------|------|----|----|----------|-----|----|----|----|-------------|
| RX1-540 Pole bracket, single | 111-0054 | 1000 | | | 76 x 130 | 550 | | | | 6.8 |

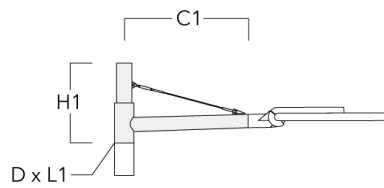

AFL130-WL LED

| Description | Part ID | C1 | D1 | D2 | D x L1 | H1 | H2 | M1 | M2 | Weight (kg) |
|------------------------------|----------|------|----|----|----------|-----|----|----|----|-------------|
| RX2-540 Pole bracket, double | 111-0055 | 1000 | | | 76 x 130 | 550 | | | | 9.70 |



| | | | | | | | | | | |
|----------------------|----------|------|-----|-----|--|-----|-----|----|----|------|
| RX0-540 Wall bracket | 111-0086 | 1000 | 140 | 100 | | 450 | 385 | 30 | 12 | 5.20 |
|----------------------|----------|------|-----|-----|--|-----|-----|----|----|------|

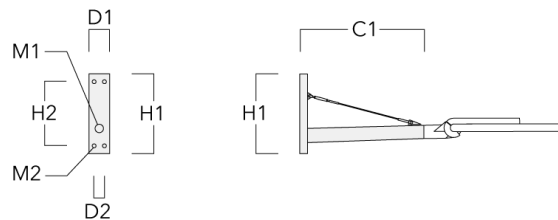

102-0290

AFL130-WL LED

we-ef

Optical Accessories

Backlight shield

| Description | Part ID | Additional information |
|-------------|----------|---|
| LS180 | 003-4123 | Glare Shield for backlight spill. Glare Shield factory-installed or available as retrofit kit. Suitable for [S61][S66][R61][P66][Q66][A61] lenses. Must be specified at time of ordering. |



102-0290

AFL130-WL LED

WE-EF LIGHTING Pty Ltd

6/13 Downard Street, 3195 Braeside, Victoria

Phone: +61 3 8587 0444

Fax: +61 3 8587 0499

info.australia@we-ef.com

<https://we-ef.com/aus>

Subject to technical changes and errors.

Generated on 23/10/2024