

102-0292

AFL130-WL LED

we-ef



Description

Wild-Light. IP66, Class I or Class II. IK08. Marine-grade, die-cast aluminium alloy. 5CE superior corrosion protection including PCS hardware. CCG® Controlled Compression Gasket. Non-reflecting flat safety glass cover, hinged. Integral EC electronic converter in thermally separated compartment. CAD-optimised optics for superior illumination and glare control. OLC® One LED Concept. Factory installed LED circuit board. Wild-Light with Advanced or Motion available on request, must be specified at time of ordering. For further details and available variants see below under additional information - Wild-Light Presentation. The luminaire is factory-sealed and does not need to be opened during installation. Can be used as post top or side entry version. Specification at time of order is recommended.

Spigot Ø 76 x 100 mm. Spigot Ø 60 x 100 mm or 42 x 100 mm optional available. Must be indicated during order placement.

Contact WE-EF direct or your local WE-EF sales representative for an individual solution designed to precisely meet your needs.

IMPORTANT

WE-EF LIGHTING USA, LLC

410-D Keystone Drive, 15086 Warrendale, PA 15086 - Phone: +1 724 742 0030
customersupport.usa@we-ef.com - <https://we-ef.com/us>
Subject to technical changes and errors. - Generated on 11/23/2024

| | |
|---------------------------|------------------------------------|
| Weight | 19 lb |
| Light distribution | [S65] Type III Medium |
| Light source | LED-16-32/16W-64W/True Amber-2200K |
| CRI | NA/70 |
| Power supply | electronic gear |
| LEDs | 48 |
| Rated input power | 83 W |
| Nominal Lumen (lm) | |
| LED Lumen | 193.3 |
| Total Lumen | 9280 |
| Tj | 85 |
| Rated lumens (lm) | |
| LED Lumen | 176.7 |
| Total Lumen | 8482.4 |
| Ta | 25 |

102-0292

we-ef

AFL130-WL LED

Photometric data legend (for ies-data):

Part ID (channel I+II - both colour temperatures 1850K (True Amber) + 2200K / 2200K + 3000K)

Part ID_1 (channel I - lower colour temperature 1850K (True Amber) / 2200K only)

Part ID_2 (channel II - upper colour temperature 2200K / 3000K only)

Photometric data legend (for ldt-data):

Part ID (channel I+II - both colour temperatures 1850K (True Amber) + 2200K / 2200K + 3000K)

Part ID (channel I - lower colour temperature 1850K (True Amber) / 2200K only)

Part ID (channel II - upper colour temperature 2200K / 3000K only)

Photometric files (IES, LDT) for light distributions [S61][S65][S66][S70][R60][R61][P66][Q66][A61] with Backlight Shield on request.

WE-EF LIGHTING USA, LLC

410-D Keystone Drive, 15086 Warrendale, PA 15086 - Phone: +1 724 742 0030
customersupport.usa@we-ef.com - <https://we-ef.com/us>

Subject to technical changes and errors. - Generated on 11/23/2024

102-0292

we-ef

AFL130-WL LED

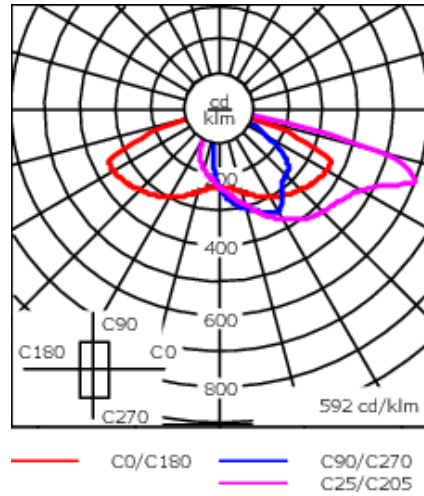
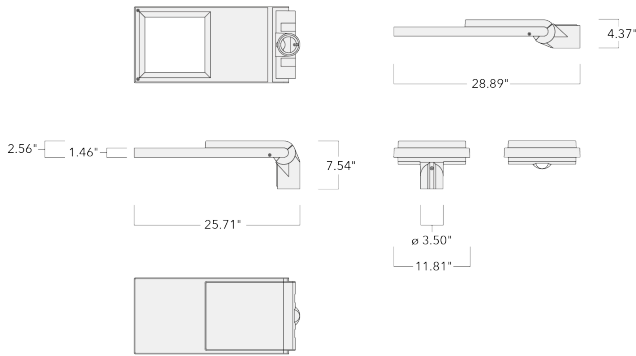

Specifications

Material description

| | |
|----------------------|--|
| Body | Marine-grade, die-cast aluminium alloy |
| Lens | Non-reflective safety glass lens |
| Colors | <ul style="list-style-type: none"> RAL9004 Black RAL9007 Grey Metallic RAL9016 White RAL8019 Dark Bronze |
| Gasket | CCG® Controlled Compression Gasket |
| Fasteners | PCS Polymer Coated Stainless Steel Hardware |
| Ingress protection | IP66 |
| Impact resistance | IK08 |
| Corrosion resistance | 5CE |
| Windage | 0.1956 m ² |

Electrical description

| | |
|------------------|--|
| Driver / Ballast | Integral EC electronic converter. DALI |
| Power factor | > 0.9 |
| Surge protection | 6/6kV, optional 10kV |

Additional information

| | |
|----------|----------------------------|
| Lifetime | Ta=25°/40° L90B10 > 90000h |
|----------|----------------------------|

WE-EF LIGHTING USA, LLC

410-D Keystone Drive, 15086 Warrendale, PA 15086 - Phone: +1 724 742 0030

customersupport.usa@we-ef.com - <https://we-ef.com/us>

Subject to technical changes and errors. - Generated on 11/23/2024

102-0292

we-ef

AFL130-WL LED

Mounting Accessories

Bird deterrent

| Description | Part ID |
|-------------------|----------|
| Bird deterrent BD | 430-0015 |

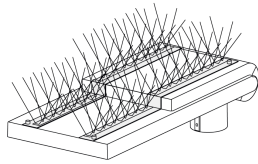

WE-EF LIGHTING USA, LLC

410-D Keystone Drive, 15086 Warrendale, PA 15086 - Phone: +1 724 742 0030
customersupport.usa@we-ef.com - <https://we-ef.com/us>

Subject to technical changes and errors. - Generated on 11/23/2024

102-0292

we-ef

AFL130-WL LED

Adaptor

| Description | Part ID |
|----------------|----------|
| Adaptor AFL100 | 102-0392 |

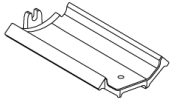

Wall and pole brackets RE

| Description | Part ID | C1 | D1 | D2 | D x L1 | H1 | M1 | Weight (lb) |
|------------------------------|----------|------|----|----|--------|-------|----|-------------|
| RE2-540 Pole bracket, double | 111-0043 | 7.87 | | | 3 x 5 | 21.65 | | 11.68 |

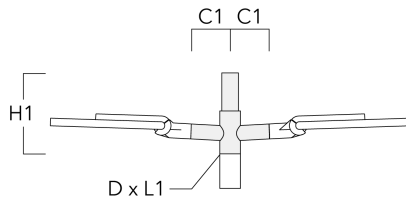

WE-EF LIGHTING USA, LLC

410-D Keystone Drive, 15086 Warrendale, PA 15086 - Phone: +1 724 742 0030
customersupport.usa@we-ef.com - <https://we-ef.com/us>

Subject to technical changes and errors. - Generated on 11/23/2024

AFL130-WL LED

| Description | Part ID | C1 | D1 | D2 | D × L1 | H1 | M1 | Weight (lb) |
|----------------------|----------|------|------|------|--------|----|------|-------------|
| RE0-540 Wall bracket | 111-0084 | 7.09 | 9.06 | 7.68 | | | 0.47 | 7.05 |



| | | | | | | | | |
|------------------------------|----------|-----|--|--|-------|-----|--|------|
| RE1-540 Pole bracket, single | 111-0042 | 200 | | | 3 x 5 | 500 | | 4.60 |
|------------------------------|----------|-----|--|--|-------|-----|--|------|

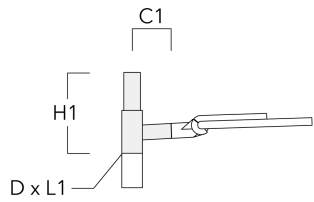

WE-EF LIGHTING USA, LLC

410-D Keystone Drive, 15086 Warrendale, PA 15086 - Phone: +1 724 742 0030
 customersupport.usa@we-ef.com - <https://we-ef.com/us>
 Subject to technical changes and errors. - Generated on 11/23/2024

AFL130-WL LED

Pole brackets RF

| Description | Part ID | C1 | D x L1 | H1 | Weight (lb) |
|------------------------------|----------|------|--------|------|-------------|
| RF2-540 Pole bracket, double | 111-0047 | 7.87 | 3 x 3 | 7.87 | 7.28 |

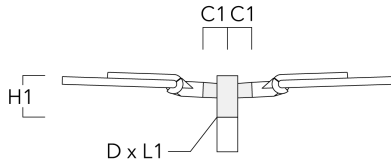

| | | | | | |
|------------------------------|----------|-----|-------|-----|------|
| RF1-540 Pole bracket, single | 111-0046 | 200 | 3 x 3 | 200 | 2.60 |
|------------------------------|----------|-----|-------|-----|------|

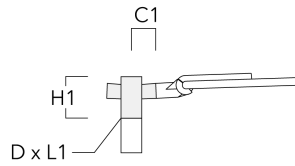

WE-EF LIGHTING USA, LLC

410-D Keystone Drive, 15086 Warrendale, PA 15086 - Phone: +1 724 742 0030

customersupport.usa@we-ef.com - <https://we-ef.com/us>

Subject to technical changes and errors. - Generated on 11/23/2024

Wall and pole brackets RX

| Description | Part ID | C1 | D1 | D2 | D x L1 | H1 | H2 | M1 | M2 | Weight (lb) |
|------------------------------|----------|-------|----|----|-------------|-------|----|----|----|-------------|
| RX1-540 Pole bracket, single | 111-0054 | 39.37 | | | 2.99 x 3.15 | 21.65 | | | | 14.99 |

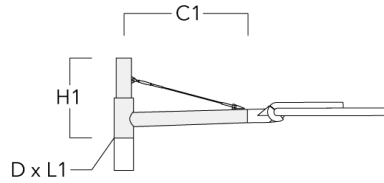

| | | | | | | | | | | |
|------------------------------|----------|-------|--|--|-------------|-------|--|--|--|-------|
| RX2-540 Pole bracket, double | 111-0055 | 39.37 | | | 2.99 x 3.15 | 21.65 | | | | 21.38 |
|------------------------------|----------|-------|--|--|-------------|-------|--|--|--|-------|

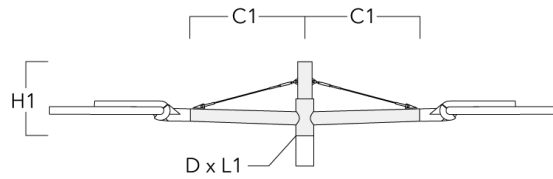

AFL130-WL LED

| Description | Part ID | C1 | D1 | D2 | D × L1 | H1 | H2 | M1 | M2 | Weight (lb) |
|----------------------|----------|-------|------|------|--------|-------|-------|------|------|-------------|
| RX0-540 Wall bracket | 111-0086 | 39.37 | 5.51 | 3.94 | | 17.72 | 15.16 | 1.18 | 0.47 | 11.46 |

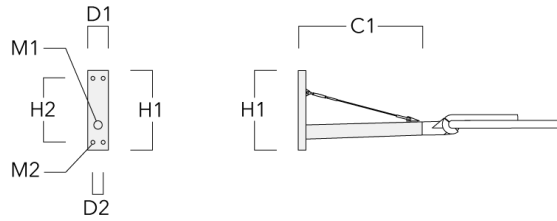

WE-EF LIGHTING USA, LLC

410-D Keystone Drive, 15086 Warrendale, PA 15086 - Phone: +1 724 742 0030
customersupport.usa@we-ef.com - <https://we-ef.com/us>
Subject to technical changes and errors. - Generated on 11/23/2024

102-0292

we-ef

AFL130-WL LED

Optical Accessories

Backlight shield

| Description | Part ID | Additional information |
|-------------|----------|---|
| LS180 | 430-0029 | Glare Shield for backlight spill. Glare Shield factory-installed or available as retrofit kit. Suitable for [S61][S66][R61][P66][Q66][A61] lenses. Must be specified at time of ordering. |

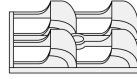

WE-EF LIGHTING USA, LLC

410-D Keystone Drive, 15086 Warrendale, PA 15086 - Phone: +1 724 742 0030
customersupport.usa@we-ef.com - <https://we-ef.com/us>
Subject to technical changes and errors. - Generated on 11/23/2024