

105-9817

RMC320 LED

we-ef

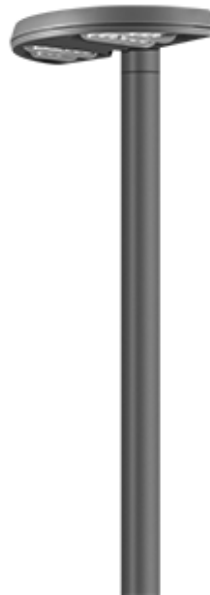

Description

Surface-mounted wall luminaire.

IP66. Class I. IK07. Marine-grade, die-cast aluminum alloy. 5CE superior corrosion protection including PCS hardware. Silicone CCG® Controlled Compression Gasket. Safety glass lens. Two cable entries. CAD-optimized optics for superior illumination and glare control. Integral driver. OLC® One LED Concept. Factory-installed LED circuit board. 0-10V Dimming comes standard with luminaire.

Suitable for Up, Down, or Up/Down light distribution. Suitable for installation over 4" recessed junction box. Emergency Lighting Package option available; to be specified as accessory with order.

Specify product with 7 Digit product code - Finish Color. Accessories, such as mounting, optical, and electrical, must be specified separately.

Example: XXX-XXXX-9004 (Black)
+ XXX-XXXX (Accessory 1)

| | |
|--------------------|------------------------------|
| Weight | 16.50 lb |
| Light distribution | [A60] Type IV Very Short |
| Light source | LED-18/36W / 700 mA - 3000 K |
| CRI | 80 |
| Power supply | electronic gear |
| BUG | B1 U0 G2 |
| LEDs | 18 |
| Rated input power | 41 W |

Nominal Lumen (lm)

| | |
|-------------|------|
| LED Lumen | 290 |
| Total Lumen | 5220 |
| Tj | 85 |

Rated lumens (lm)

| | |
|-------------|-------|
| LED Lumen | 223.8 |
| Total Lumen | 4028 |
| Ta | 25 |

WE-EF LIGHTING USA, LLC

410-D Keystone Drive, 15086 Warrendale, PA 15086 - Phone: +1 724 742 0030
customersupport.usa@we-ef.com - <https://we-ef.com/us>
Subject to technical changes and errors. - Generated on 11/23/2024

105-9817

RMC320 LED

we-ef

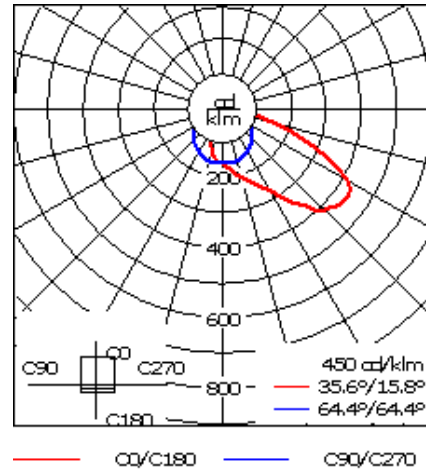
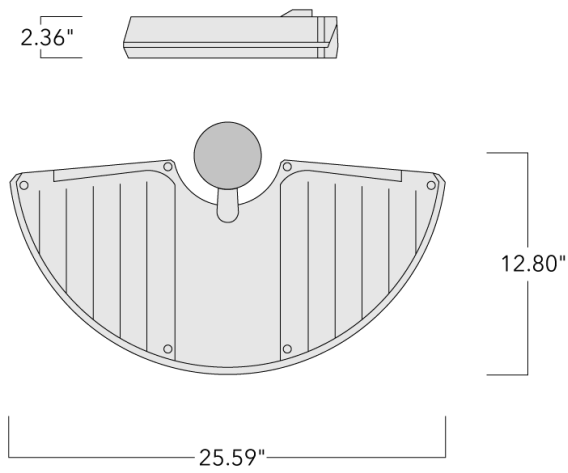

Specifications

Material description

| | |
|----------------------|---|
| Body | Marine-grade die-cast aluminium alloy |
| Lens | PMMA RFC® Reflection Free Contour technology |
| Colors | <div style="display: flex; flex-direction: column; gap: 5px;"> <div> RAL9004 Black</div> <div> RAL9007 Grey Metallic</div> <div> RAL9016 White</div> <div> RAL8019 Dark Bronze</div> </div> |
| Gasket | Silicone rubber gasket |
| Fasteners | PCS Polymer Coated Stainless Steel hardware |
| Ingress protection | IP66 |
| Impact resistance | IK08 |
| Corrosion resistance | 5CE |
| Windage | 0.4 |

WE-EF LIGHTING USA, LLC

410-D Keystone Drive, 15086 Warrendale, PA 15086 - Phone: +1 724 742 0030

customersupport.usa@we-ef.com - <https://we-ef.com/us>

Subject to technical changes and errors. - Generated on 11/23/2024

105-9817

RMC320 LED

we-ef

Electrical description

| | |
|------------------|---|
| Power supply | Integral [ECG] electronic driver 120V-277V. 0-10V dimmable, to be specified with order. |
| Driver / Ballast | Integral EC electronic converter |
| Power factor | > 0.9 |
| Surge protection | Integral 10kV Surge Protector |

Additional information

| | |
|------------|---|
| Lifetime | Ta=25°/40° L90B10 > 90000h |
| BUG Rating | Please see individual Spec Sheets for classification of Backlight, Uplight and Glare. |
| Listings | ETL, UL-1598, CSA-C22.2#250.0. Suitable for Wet Locations. |

WE-EF LIGHTING USA, LLC

410-D Keystone Drive, 15086 Warrendale, PA 15086 - Phone: +1 724 742 0030

customersupport.usa@we-ef.com - <https://we-ef.com/us>

Subject to technical changes and errors. - Generated on 11/23/2024

Mounting Accessories

Wall and pole brackets RM

| Description | Part ID | C1 | C2 | C3 | D1 | D × L1 | H1 | H2 | M1 | Weight (lb) |
|-----------------|----------|----|----|----|----|--------|----|----|----|-------------|
| RM1-76 (OD=102) | 105-9847 | | | | 4 | 3 x 3 | | | | 2.20 |

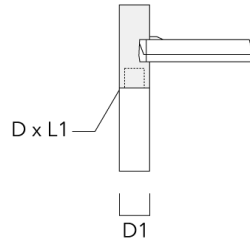

| | | | | | | | | | | |
|-------|----------|------|--|--|--------|--|------|------|------|------|
| RM1-S | 105-9845 | 1.97 | | | ≥ 2.99 | | 5.90 | 4.88 | 0.43 | 1.30 |
|-------|----------|------|--|--|--------|--|------|------|------|------|

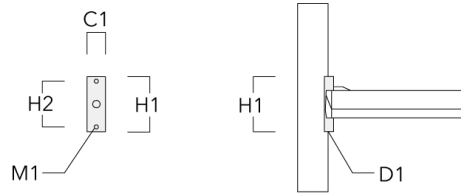

105-9817
RMC320 LED

| Description | Part ID | C1 | C2 | C3 | D1 | D × L1 | H1 | H2 | M1 | Weight (lb) |
|-------------|----------|-------|------|------|----|--------|------|------|------|-------------|
| RM1-W | 105-9846 | 14.72 | 4.17 | 3.15 | | | 6.93 | 6.10 | 0.24 | 2.90 |

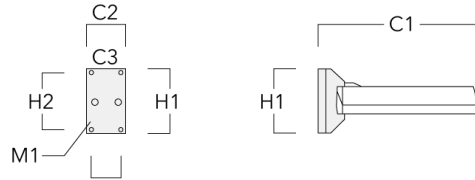

| | | | | | | | | | | |
|-----------------|----------|--|--|--|---|-------|--|--|--|------|
| RM2-76 (OD=102) | 105-9848 | | | | 4 | 3 x 3 | | | | 2.20 |
|-----------------|----------|--|--|--|---|-------|--|--|--|------|

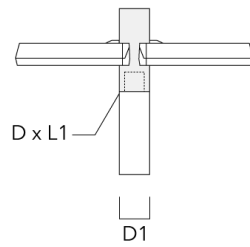

WE-EF LIGHTING USA, LLC

410-D Keystone Drive, 15086 Warrendale, PA 15086 - Phone: +1 724 742 0030
 customersupport.usa@we-ef.com - <https://we-ef.com/us>
 Subject to technical changes and errors. - Generated on 11/23/2024

105-9817

RMC320 LED

we-ef

Optical Accessories

Light shield

| Description | Part ID | Additional information |
|-------------|----------|---|
| LS180-[A60] | 430-0038 | Light shield LS180 to greatly reduce or eliminate light pollution. PA injection moulded component, black matt. Suitable for asymmetric light distribution [A60]. |
| LS180 | 430-0029 | Glare Shield for backlight spill. Glare Shield factory-installed or available as retrofit kit. Suitable for [S60], [S65], [S70], [R65], [P65] lenses. Must be specified at time of ordering. |

WE-EF LIGHTING USA, LLC

410-D Keystone Drive, 15086 Warrendale, PA 15086 - Phone: +1 724 742 0030
customersupport.usa@we-ef.com - <https://we-ef.com/us>

Subject to technical changes and errors. - Generated on 11/23/2024