

102-0389

AFL130-WL LED

**we-ef**



**Description**

Wild-Light. IP66, Class I or Class II. IK08. Marine-grade, die-cast aluminium alloy. 5CE superior corrosion protection including PCS hardware. CCG® Controlled Compression Gasket. Non-reflecting flat safety glass cover, hinged. Integral EC electronic converter in thermally separated compartment. CAD-optimised optics for superior illumination and glare control. OLC® One LED Concept. Factory installed LED circuit board. Wild-Light with Advanced or Motion available on request, must be specified at time of ordering. For further details and available variants see below under additional information - Wild-Light Presentation. The luminaire is factory-sealed and does not need to be opened during installation. Can be used as post top or side entry version. Specification at time of order is recommended.

Spigot Ø 76 x 100 mm. Spigot Ø 60 x 100 mm or 42 x 100 mm optional available. Must be indicated during order placement.

Contact WE-EF direct or your local WE-EF sales representative for an individual solution designed to precisely meet your needs.

IMPORTANT

**WE-EF LIGHTING USA, LLC**

410-D Keystone Drive, 15086 Warrendale, PA 15086 - Phone: +1 724 742 0030  
customersupport.usa@we-ef.com - <https://we-ef.com/us>  
Subject to technical changes and errors. - Generated on 10/23/2024

Weight	19 lb
Light distribution	asymmetric, side throw [S71]
Light source	LED-16-32/16W-64W/True Amber-2200K
CRI	NA/70
Power supply	electronic gear
LEDs	48
Rated input power	83 W
<b>Nominal Lumen (lm)</b>	
LED Lumen	193.3
Total Lumen	9280
Tj	85
<b>Rated lumens (lm)</b>	
LED Lumen	159.4
Total Lumen	7651.4
Ta	25

**102-0389**

**we-ef**

**AFL130-WL LED**

Photometric data legend (for ies-data):

Part ID (channel I+II - both colour temperatures 1850K (True Amber) + 2200K / 2200K + 3000K)

Part ID\_1 (channel I - lower colour temperature 1850K (True Amber) / 2200K only)

Part ID\_2 (channel II - upper colour temperature 2200K / 3000K only)

Photometric data legend (for ldt-data):

Part ID (channel I+II - both colour temperatures 1850K (True Amber) + 2200K / 2200K + 3000K)

Part ID (channel I - lower colour temperature 1850K (True Amber) / 2200K only)

Part ID (channel II - upper colour temperature 2200K / 3000K only)

Photometric files (IES, LDT) for light distributions [S61][S65][S66][S70][R60][R61][P66][Q66][A61] with Backlight Shield on request.

**WE-EF LIGHTING USA, LLC**

410-D Keystone Drive, 15086 Warrendale, PA 15086 - Phone: +1 724 742 0030  
customersupport.usa@we-ef.com - <https://we-ef.com/us>

Subject to technical changes and errors. - Generated on 10/23/2024

102-0389

we-ef

AFL130-WL LED

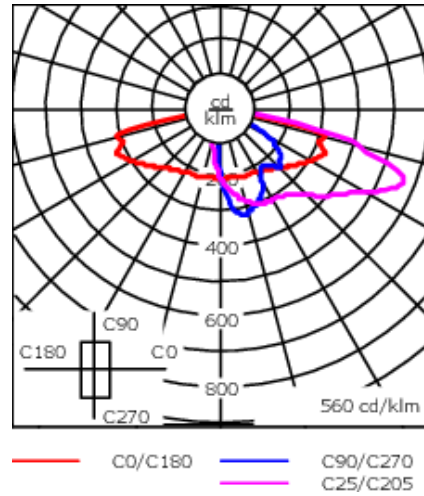
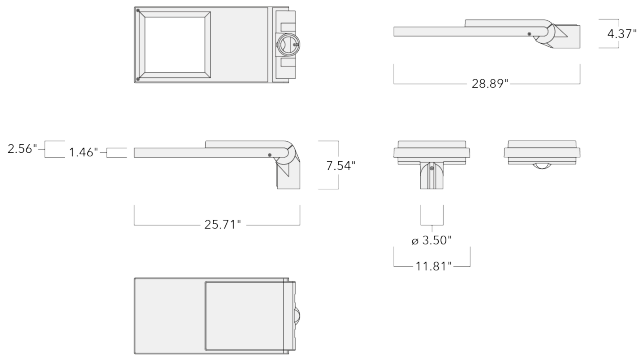

## Specifications

### Material description

Body	Marine-grade, die-cast aluminium alloy
Lens	Non-reflective safety glass lens
Colors	<ul style="list-style-type: none"> <li><span style="display: inline-block; width: 15px; height: 15px; background-color: black; margin-right: 5px;"></span> RAL9004 Black</li> <li><span style="display: inline-block; width: 15px; height: 15px; background-color: grey; margin-right: 5px;"></span> RAL9007 Grey Metallic</li> <li><span style="display: inline-block; width: 15px; height: 15px; background-color: white; margin-right: 5px;"></span> RAL9016 White</li> <li><span style="display: inline-block; width: 15px; height: 15px; background-color: darkgrey; margin-right: 5px;"></span> RAL8019 Dark Bronze</li> </ul>
Gasket	CCG® Controlled Compression Gasket
Fasteners	PCS Polymer Coated Stainless Steel Hardware
Ingress protection	IP66
Impact resistance	IK08
Corrosion resistance	5CE
Windage	0.1956 m <sup>2</sup>

### Electrical description

Driver / Ballast	Integral EC electronic converter. DALI
Power factor	> 0.9
Surge protection	6/6kV, optional 10kV

### Additional information

Lifetime	Ta=25°/40° L90B10 > 90000h
----------	----------------------------

#### WE-EF LIGHTING USA, LLC

410-D Keystone Drive, 15086 Warrendale, PA 15086 - Phone: +1 724 742 0030

customersupport.usa@we-ef.com - https://we-ef.com/us

Subject to technical changes and errors. - Generated on 10/23/2024

**102-0389**

**we-ef**

**AFL130-WL LED**

## **Mounting Accessories**

### **Bird deterrent**

---

Description	Part ID
Bird deterrent BD	430-0015

---

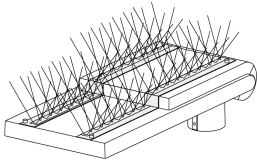

---

### **Adaptor**

**WE-EF LIGHTING USA, LLC**

410-D Keystone Drive, 15086 Warrendale, PA 15086 - Phone: +1 724 742 0030

customersupport.usa@we-ef.com - <https://we-ef.com/us>

Subject to technical changes and errors. - Generated on 10/23/2024

**AFL130-WL LED**

---

Description	Part ID
Adaptor AFL100	102-0392

---

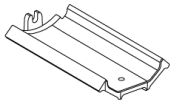

---

**Wall and pole brackets RE**

---

Description	Part ID	C1	D1	D2	D x L1	H1	M1	Weight (lb)
RE2-540 Pole bracket, double	111-0043	7.87			3 x 5	21.65		11.68

---

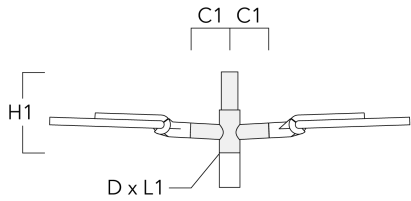

---

**WE-EF LIGHTING USA, LLC**

410-D Keystone Drive, 15086 Warrendale, PA 15086 - Phone: +1 724 742 0030

customersupport.usa@we-ef.com - <https://we-ef.com/us>

Subject to technical changes and errors. - Generated on 10/23/2024

**AFL130-WL LED**

Description	Part ID	C1	D1	D2	D × L1	H1	M1	Weight (lb)
RE0-540 Wall bracket	111-0084	7.09	9.06	7.68			0.47	7.05

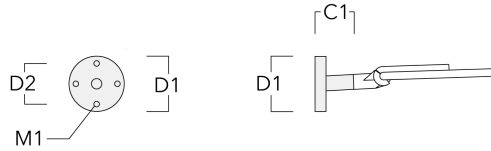

RE1-540 Pole bracket, single	111-0042	200			3 x 5	500		4.60
------------------------------	----------	-----	--	--	-------	-----	--	------

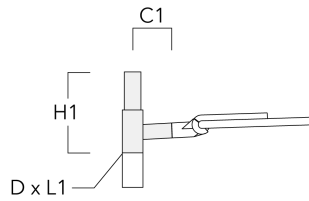

**Pole brackets RF**

**WE-EF LIGHTING USA, LLC**

410-D Keystone Drive, 15086 Warrendale, PA 15086 - Phone: +1 724 742 0030

customersupport.usa@we-ef.com - <https://we-ef.com/us>

Subject to technical changes and errors. - Generated on 10/23/2024

**AFL130-WL LED**

Description	Part ID	C1	D × L1	H1	Weight (lb)
RF2-540 Pole bracket, double	111-0047	7.87	3 x 3	7.87	7.28

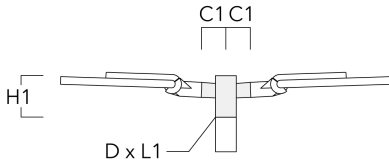

RF1-540 Pole bracket, single	111-0046	200	3 x 3	200	2.60
------------------------------	----------	-----	-------	-----	------

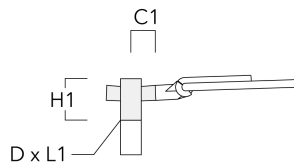

**Wall and pole brackets RX**

**WE-EF LIGHTING USA, LLC**

410-D Keystone Drive, 15086 Warrendale, PA 15086 - Phone: +1 724 742 0030

customersupport.usa@we-ef.com - <https://we-ef.com/us>

Subject to technical changes and errors. - Generated on 10/23/2024

**AFL130-WL LED**

Description	Part ID	C1	D1	D2	D x L1	H1	H2	M1	M2	Weight (lb)
RX1-540 Pole bracket, single	111-0054	39.37			2.99 x 3.15	21.65				14.99

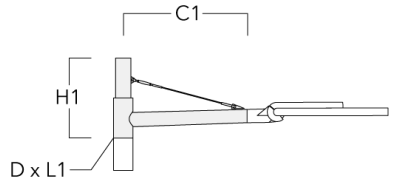

RX2-540 Pole bracket, double	111-0055	39.37			2.99 x 3.15	21.65				21.38
------------------------------	----------	-------	--	--	-------------	-------	--	--	--	-------

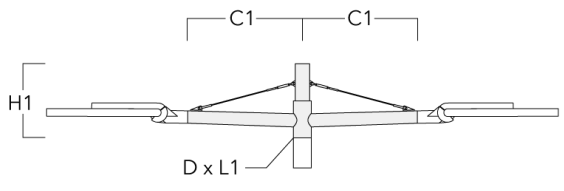

**WE-EF LIGHTING USA, LLC**

410-D Keystone Drive, 15086 Warrendale, PA 15086 - Phone: +1 724 742 0030  
 customersupport.usa@we-ef.com - <https://we-ef.com/us>  
 Subject to technical changes and errors. - Generated on 10/23/2024



**AFL130-WL LED**

Description	Part ID	C1	D1	D2	D × L1	H1	H2	M1	M2	Weight (lb)
RX0-540 Wall bracket	111-0086	39.37	5.51	3.94		17.72	15.16	1.18	0.47	11.46

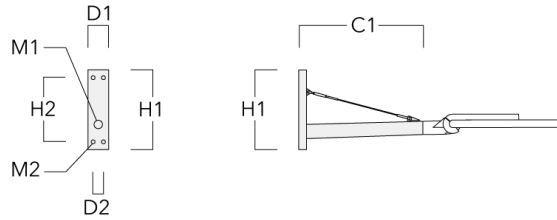

**WE-EF LIGHTING USA, LLC**

410-D Keystone Drive, 15086 Warrendale, PA 15086 - Phone: +1 724 742 0030

customersupport.usa@we-ef.com - <https://we-ef.com/us>

Subject to technical changes and errors. - Generated on 10/23/2024

**102-0389**

**we-ef**

**AFL130-WL LED**

## **Optical Accessories**

### **Backlight shield**

Description	Part ID	Additional information
LS180	430-0029	Glare Shield for backlight spill. Glare Shield factory-installed or available as retrofit kit. Suitable for [S61][S66][R61][P66][Q66][A61] lenses. Must be specified at time of ordering.

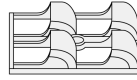

**WE-EF LIGHTING USA, LLC**

410-D Keystone Drive, 15086 Warrendale, PA 15086 - Phone: +1 724 742 0030

customersupport.usa@we-ef.com - <https://we-ef.com/us>

Subject to technical changes and errors. - Generated on 10/23/2024

**102-0389**

**AFL130-WL LED**

**WE-EF LIGHTING USA, LLC**

410-D Keystone Drive, 15086 Warrendale, PA 15086

Phone: +1 724 742 0030

[customersupport.usa@we-ef.com](mailto:customersupport.usa@we-ef.com)

<https://we-ef.com/us>

Subject to technical changes and errors.

Generated on 10/23/2024

**we-ef**

---

A Fagerhult Group Company