

102-0391

AFL130-WL LED

**we-ef**



### Description

Wild-Light. IP66, Class I or Class II. IK08. Marine-grade, die-cast aluminium alloy. 5CE superior corrosion protection including PCS hardware. CCG® Controlled Compression Gasket. Non-reflecting flat safety glass cover, hinged. Integral EC electronic converter in thermally separated compartment. CAD-optimised optics for superior illumination and glare control. OLC® One LED Concept. Factory installed LED circuit board. Wild-Light with Advanced or Motion available on request, must be specified at time of ordering. For further details and available variants see below under additional information - Wild-Light Presentation. The luminaire is factory-sealed and does not need to be opened during installation. Can be used as post top or side entry version. Specification at time of order is recommended.

Spigot Ø 76 x 100 mm. Spigot Ø 60 x 100 mm or 42 x 100 mm optional available. Must be indicated during order placement.

Contact WE-EF direct or your local WE-EF sales representative for an individual solution designed to precisely meet your needs.

### IMPORTANT

Photometric data legend (for ies-data):

### WE-EF LIGHTING Pty Ltd

6/13 Downard Street, 3195 Braeside, Victoria - Phone: +61 3 8587 0444 - Fax: +61 3 8587 0499

info.australia@we-ef.com - <https://we-ef.com/aus>

Subject to technical changes and errors. - Generated on 23/10/2024

Weight	8.6 kg
Light distribution	rectangular, side throw [R61]
Light source	LED-16-32/16W-64W/True Amber-2200K
CRI	NA/70
Power supply	EC
LEDs	48
Rated input power	83 W

<b>Nominal Lumen (lm)</b>	
LED Lumen	193.3
Total Lumen	9280
Tj	85

<b>Rated lumens (lm)</b>	
LED Lumen	159.8
Total Lumen	7669.9
Ta	25

**102-0391**

**AFL130-WL LED**

**we-ef**

Part ID (channel I+II - both colour temperatures 1850K (PC Amber) + 2200K / 2200K + 3000K)

Part ID\_1 (channel I - lower colour temperature 1850K (PC Amber) / 2200K only)

Part ID\_2 (channel II - upper colour temperature 2200K / 3000K only)

Photometric data legend (for ldt-data):

Part ID (channel I+II - both colour temperatures 1850K (PC Amber) + 2200K / 2200K + 3000K)

Part ID (channel I - lower colour temperature 1850K (PC Amber) / 2200K only)

Part ID (channel II - upper colour temperature 2200K / 3000K only)

Photometric files (IES, LDT) for light distributions [S61] [S65] [S66] [S70] [R60] [R61] [P66] [Q66] [A61] with Back-light Shield on request.

**WE-EF LIGHTING Pty Ltd**

6/13 Downard Street, 3195 Braeside, Victoria - Phone: +61 3 8587 0444 - Fax: +61 3 8587 0499

info.australia@we-ef.com - <https://we-ef.com/aus>

Subject to technical changes and errors. - Generated on 23/10/2024

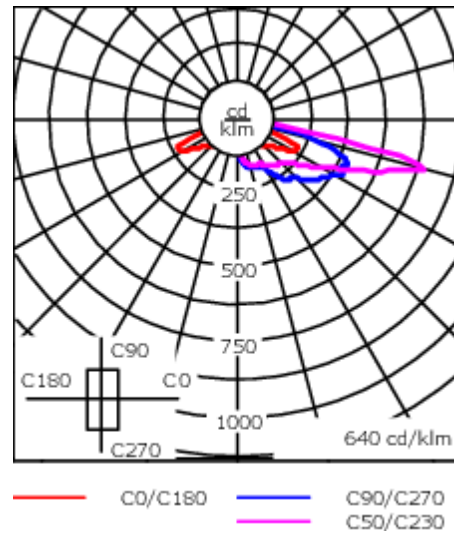
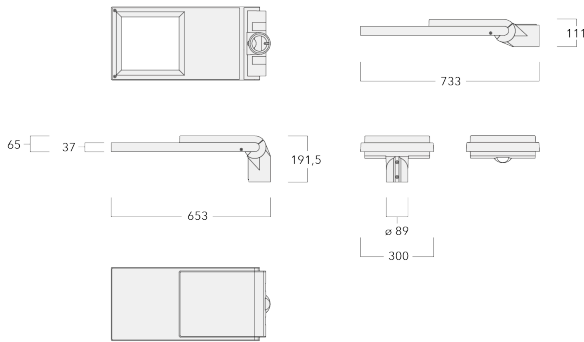
**102-0391****AFL130-WL LED****we-ef**

## Specifications

### Material description

Body	Marine-grade, die-cast aluminium alloy
Lens	Non-reflective safety glass lens
Colours	<div style="display: flex; align-items: center;"> <div style="width: 20px; height: 15px; background-color: black; margin-right: 5px;"></div> <span>RAL9004 Signal black</span> </div> <div style="display: flex; align-items: center; margin-top: 5px;"> <div style="width: 20px; height: 15px; background-color: #cccccc; margin-right: 5px;"></div> <span>RAL9006 White aluminium</span> </div> <div style="display: flex; align-items: center; margin-top: 5px;"> <div style="width: 20px; height: 15px; background-color: #808080; margin-right: 5px;"></div> <span>RAL9007 Grey aluminium</span> </div>
Gasket	CCG® Controlled Compression Gasket
Fasteners	PCS Polymer Coated Stainless Steel Hardware
Ingress protection	IP66
Impact resistance	IK08
Corrosion resistance	5CE
Windage	0.1956 m <sup>2</sup>

### Electrical description

Driver / Ballast	Integral EC electronic converter. DALI
Power factor	> 0.9
Surge protection	In-pole surge protection SP10 device supplied. Please refer to WE-EF installation instructions for details. Use suffix +A for Integral surge protection.

### Additional information

Lifetime	Ta=40° L90B10 > 90000h
----------	------------------------

#### WE-EF LIGHTING Pty Ltd

6/13 Downard Street, 3195 Braeside, Victoria - Phone: +61 3 8587 0444 - Fax: +61 3 8587 0499

info.australia@we-ef.com - <https://we-ef.com/aus>

Subject to technical changes and errors. - Generated on 23/10/2024

**102-0391**

**AFL130-WL LED**

**we-ef**

## **Control**

### **R2C Ready to Connect**

Description	Part ID
R2C Ready to Connect (top)	430-0019
R2C Ready to Connect (below)	430-0027
R2C Ready to Connect (top and below)	430-0032

**WE-EF LIGHTING Pty Ltd**

6/13 Downard Street, 3195 Braeside, Victoria - Phone: +61 3 8587 0444 - Fax: +61 3 8587 0499

info.australia@we-ef.com - <https://we-ef.com/aus>

Subject to technical changes and errors. - Generated on 23/10/2024

**102-0391**

**AFL130-WL LED**

**we-ef**

## Mounting Accessories

### Bird deterrent

---

Description	Part ID
Bird deterrent BD	430-0015

---

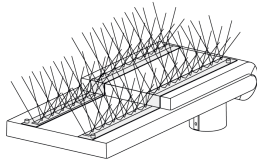

---

### Adaptor

---

Description	Part ID
Adaptor AFL100	102-0392

---

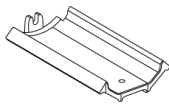

---

### Wall and pole brackets RE

#### **WE-EF LIGHTING Pty Ltd**

6/13 Downard Street, 3195 Braeside, Victoria - Phone: +61 3 8587 0444 - Fax: +61 3 8587 0499

info.australia@we-ef.com - <https://we-ef.com/aus>

Subject to technical changes and errors. - Generated on 23/10/2024

102-0391

AFL130-WL LED

**we-ef**

Description	Part ID	Additional information	C1	D1	D2	D × L1	H1	M1	Weight (kg)
RE2-540 Pole bracket, double	111-0043		200			76 x 130	550		5.30

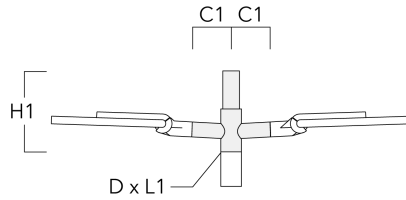

RE0-540 Wall bracket	111-0084		180	230	195			12	3.20
----------------------	----------	--	-----	-----	-----	--	--	----	------

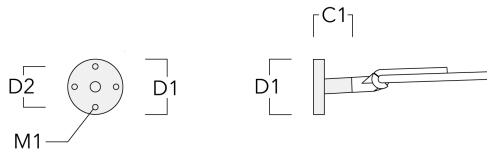

**WE-EF LIGHTING Pty Ltd**

6/13 Downard Street, 3195 Braeside, Victoria - Phone: +61 3 8587 0444 - Fax: +61 3 8587 0499

info.australia@we-ef.com - <https://we-ef.com/aus>

Subject to technical changes and errors. - Generated on 23/10/2024

**AFL130-WL LED**

Description	Part ID	Additional information	C1	D1	D2	D × L1	H1	M1	Weight (kg)
Pole bracket RE1, single for mounting on AML-A poles	111-9022	Mounting brackets. Marine-grade aluminium alloy. 5CE superior corrosion protection including PCS hardware.	320			76 x 76	550		6.10

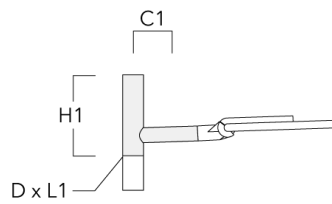

Pole bracket RE2, double for mounting on AML-A poles	111-9023	Mounting brackets. Marine-grade aluminium alloy. 5CE superior corrosion protection including PCS hardware.	320			76 x 76	550		7.20
--	----------	--	-----	--	--	---------	-----	--	------

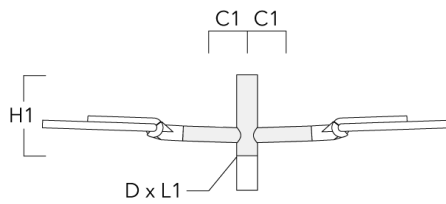

**AFL130-WL LED**

Description	Part ID	Additional information	C1	D1	D2	D × L1	H1	M1	Weight (kg)
RE1-540 Pole bracket, single	111-0042		200			76 x 130	500		4.60

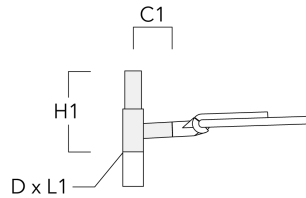

**Pole brackets RF**

Description	Part ID	C1	D × L1	H1	Weight (kg)
RF2-540 Pole bracket, double	111-0047	200	76 x 80	200	3.30

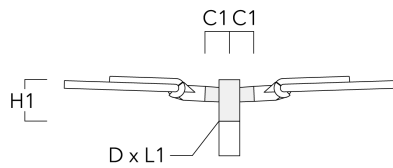



**AFL130-WL LED**

Description	Part ID	C1	D × L1	H1	Weight (kg)
RF1-540 Pole bracket, single	111-0046	200	76 x 80	200	2.60

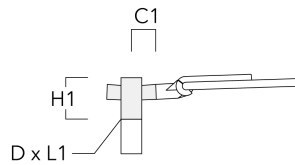

**Wall and pole brackets RX**

Description	Part ID	C1	D1	D2	D × L1	H1	H2	M1	M2	Weight (kg)
RX1-540 Pole bracket, single	111-0054	1000			76 x 130	550				6.8

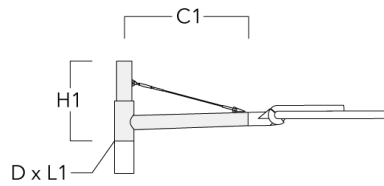

**AFL130-WL LED**

Description	Part ID	C1	D1	D2	D × L1	H1	H2	M1	M2	Weight (kg)
RX2-540 Pole bracket, double	111-0055	1000			76 x 130	550				9.70

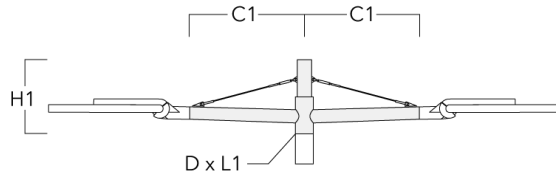

RX0-540 Wall bracket	111-0086	1000	140	100		450	385	30	12	5.20
----------------------	----------	------	-----	-----	--	-----	-----	----	----	------

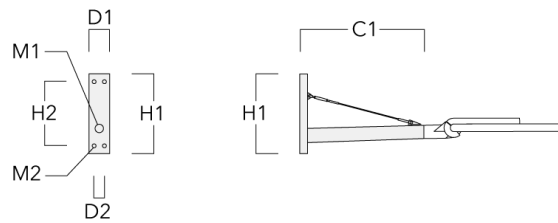

**102-0391**

**AFL130-WL LED**

**we-ef**

## Optical Accessories

### Backlight shield

Description	Part ID	Additional information
LS180	003-4123	Glare Shield for backlight spill. Glare Shield factory-installed or available as retrofit kit. Suitable for [S61][S66][R61][P66][Q66][A61] lenses. Must be specified at time of ordering.

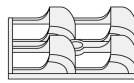

**WE-EF LIGHTING Pty Ltd**

6/13 Downard Street, 3195 Braeside, Victoria - Phone: +61 3 8587 0444 - Fax: +61 3 8587 0499

info.australia@we-ef.com - <https://we-ef.com/aus>

Subject to technical changes and errors. - Generated on 23/10/2024

**102-0391**

**AFL130-WL LED**

**WE-EF LIGHTING Pty Ltd**

6/13 Downard Street, 3195 Braeside, Victoria

Phone: +61 3 8587 0444

Fax: +61 3 8587 0499

info.australia@we-ef.com

<https://we-ef.com/aus>

Subject to technical changes and errors.

Generated on 23/10/2024

**we-ef**

---

A Fagerhult Group Company