

102-0414

AFL130-WL LED

**we-ef**

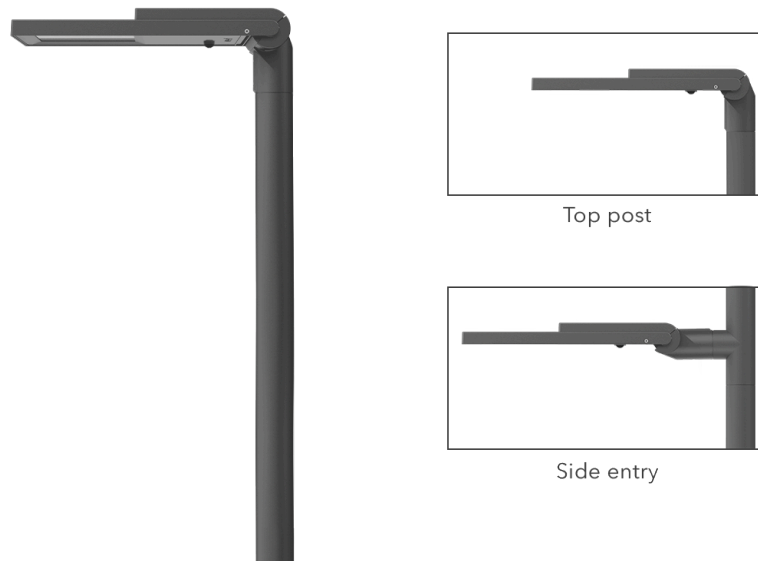

### Description

Wild-Light. IP66, Class I or Class II. IK08. Marine-grade, die-cast aluminium alloy. 5CE superior corrosion protection including PCS hardware. CCG® Controlled Compression Gasket. Non-reflective flat safety glass cover, hinged. Luminaire is factory-sealed and does not need to be opened during installation.

Integral EC electronic converter. DALI interface. CAD-optimised optics for superior illumination and glare control. OLC® One LED Concept.

Suitable for using as post top or side entry version. Recommend to be specified at time of ordering.

Optional spigot adaptor Ø 60 x 100 mm or 42 x 100 mm available; refer to accessory listings.

For other colour configurations available on request.

Weight	8.60 kg
Light distribution	pedestrian/bicycle lane [P66]
Light source	LED-8-40/16W-80W/PC Amber-3000K
CRI	60/80
Power supply	EC
LEDs	48
Rated input power	104 W
<b>Nominal Lumen (lm)</b>	
LED Lumen	276.7
Total Lumen	13280
T <sub>j</sub>	85
<b>Rated lumens (lm)</b>	
LED Lumen	243.8
Total Lumen	11702.9
T <sub>a</sub>	25

**WE-EF LIGHTING (Thailand) Co., Ltd.**

57 Moo 5, Kingkaew Rd., Bangplee, 10540 Samutprakarn - Phone: +66 2 738 96 20 - Fax: +66 2 738 96 29

<https://we-ef.com/asia>

Subject to technical changes and errors. - Generated on 23/11/2024

102-0414



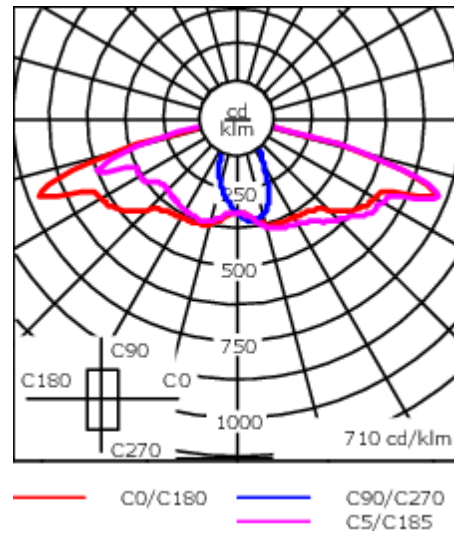
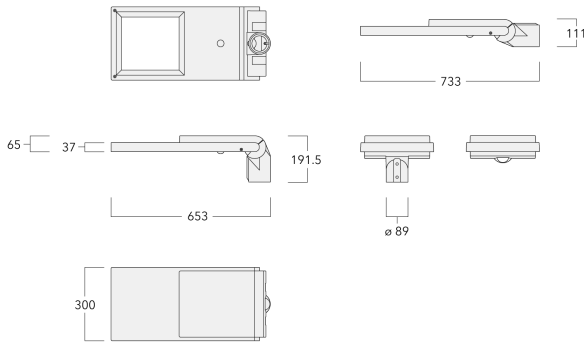

AFL130-WL LED

**we-ef**



## Specifications

### Material description

Body	Marine-grade, die-cast aluminium alloy
Lens	Non-reflective safety glass lens
Colours	 RAL9004 Signal black  RAL9007 Grey aluminium  RAL7016 Anthracite grey  RAL9016 Traffic white
Gasket	CCG <sup>®</sup> Controlled Compression Gasket
Fasteners	PCS Polymer Coated Stainless Steel Hardware
Ingress protection	IP66
Impact resistance	IK08
Corrosion resistance	5CE
Windage	0.1956 m <sup>2</sup>

### Electrical description

Driver / Ballast	Integral electronic converter with DALI interface
Power factor	> 0.9
Surge protection	6/6kV, optional 10kV

### Additional information

Lifetime	T <sub>a</sub> =25° L90B10 > 90000h
----------	-------------------------------------

**WE-EF LIGHTING (Thailand) Co., Ltd.**

57 Moo 5, Kingkaew Rd., Bangplee, 10540 Samutprakarn - Phone: +66 2 738 96 20 - Fax: +66 2 738 96 29

<https://we-ef.com/asia>

Subject to technical changes and errors. - Generated on 23/11/2024

**Control****R2C Ready to Connect**

Description	Part ID
R2C Ready to Connect (top)	430-0019
R2C Ready to Connect (below)	430-0027
R2C Ready to Connect (top and below)	430-0032

**Wild-Light Eco Step Dim® Advanced**

Description	Part ID	Additional information
Wild-Light Eco Step Dim® Advanced	430-0034	<p>Fully automatic independent dimming pre-set, without additional installation effort, Example: Starting the night with warm white (3000 K from 20:00 to 22:00), reduced to biodiversity friendly in the heart of the night (2200 K from 22:00 to 06:00), and returning back to warm white in the early morning (3000 K from 06:00 to 07:00).</p> <p>This is the easiest to implement solution to create a nature-friendly lighting scenario, as no additional installations or external controls are needed. All pre-settings are made in the two LED drivers. The dimming values are programmed into the driver during the production of the luminaires. An optional link with sunrise and sunset times can mean additional optimisation. A customer-specific configuration is possible.</p> <p>The settings can be changed directly on the LED driver at any time (NFC). The necessary tool is standardised and can also be obtained from WE-EF as an optional extra.</p>

## Optical Accessories

### Backlight shield

Description	Part ID	Additional information
Backlight shield LS180	102-0959-48LED	Glare Shield for backlight spill. Suitable for [S65] [R60] lenses. Glare Shield factory-installed or available as retrofit kit. Must be specified at time of ordering.



Backlight shield LS180	102-0395-48LED	Glare Shield for backlight spill. Suitable for [S61], [S66], [R61], [P66] [Q66], [A61] lenses. Glare Shield factory-installed or available as retrofit kit. Must be specified at time of ordering.
------------------------	----------------	---



**102-0414**

**AFL130-WL LED**

**we-ef**

## Mounting Accessories

### Bird deterrent

---

Description	Part ID
Bird deterrent BD	430-0015

---

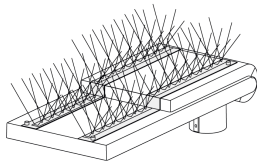

---

### Adaptor

---

Description	Part ID
Adaptor AFL100	102-0392

---



---

**WE-EF LIGHTING (Thailand) Co., Ltd.**

57 Moo 5, Kingkaew Rd., Bangplee, 10540 Samutprakarn - Phone: +66 2 738 96 20 - Fax: +66 2 738 96 29

<https://we-ef.com/asia>

Subject to technical changes and errors. - Generated on 23/11/2024

**Wall and pole brackets RE**

Description	Part ID	C1	D1	D2	D × L1	H1	M1	Weight (kg)
Pole bracket RE2-540, double	111-0043	200			76 x 130	550		5.30

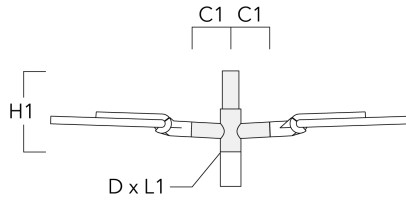

Wall bracket RE0-540	111-0084	180	230	195		12	3.20	
----------------------	----------	-----	-----	-----	--	----	------	--

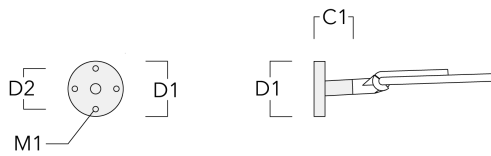

**AFL130-WL LED**

Description	Part ID	C1	D1	D2	D × L1	H1	M1	Weight (kg)
RE1-540 Pole bracket, single	111-0042	200			76 x 130	500		4.60



**Pole brackets RF**

Description	Part ID	C1	D × L1	H1	Weight (kg)
Pole bracket RF2-540, double	111-0047	200	76 x 80	200	3.30

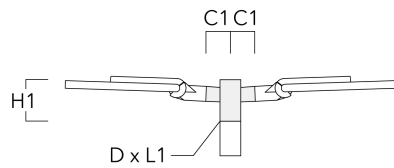

**AFL130-WL LED**

Description	Part ID	C1	D × L1	H1	Weight (kg)
RF1-540 Pole bracket, single	111-0046	200	76 x 80	200	2.60

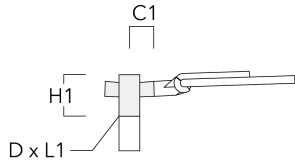

**Wall and pole brackets RX**

Description	Part ID	C1	D1	D2	D × L1	H1	H2	M1	M2	Weight (kg)
RX1-540 Pole bracket, single	111-0054	1000			76 x 130	550				6.8

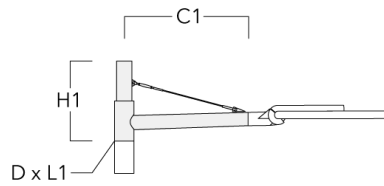



**AFL130-WL LED**

Description	Part ID	C1	D1	D2	D × L1	H1	H2	M1	M2	Weight (kg)
RX2-540 Pole bracket, double	111-0055	1000			76 x 130	550				9.70



RX0-540 Wall bracket	111-0086	1000	140	100		450	385	30	12	5.20
----------------------	----------	------	-----	-----	--	-----	-----	----	----	------

