

102-0428

AFL110 LED

we-ef



Description

IP66, Class I or Class II. IK08. Marine-grade, die-cast aluminium alloy. 5CE superior corrosion protection including PCS hardware. CCG® Controlled Compression Gasket. Non-reflective flat safety glass cover, hinged. Integral EC electronic converter. CAD-optimised optics for superior illumination and glare control. OLC® One LED Concept. Factory installed LED circuit board. The luminaire is factory-sealed and does not need to be opened during installation. Can be used as post top or side entry version. Specification at time of order is recommended.

Spigot Ø 76 x 100 mm. Spigot Ø 60 x 100 mm or 42 x 100 mm option available. Must be indicated during order placement.

Contact WE-EF direct or your local WE-EF sales representative for an individual solution designed to precisely meet your needs.

Photometric files (IES, LDT) for light distributions [S61] [S65] [S66] [S70] [R60] [R61] [P66] [Q66] [A61] with Backlight Shield on request.

Weight	4,70 kg
Light distribution	asymmetric, side throw beam [S65]
Light source	LED-8/8W / 350 mA - 3000K
CRI	80
Power supply	EC
LEDs	8
Rated input power	9.5 W

Nominal Lumen (lm)

LED Lumen	155
Total Lumen	1240
Tj	85

Rated lumens (lm)

LED Lumen	144.2
Total Lumen	1153.3
Ta	25

WE-EF LEUCHTEN GmbH

Töpinger Straße 16, 29646 Bispingen, Germany - Phone: +49 5194 909-0
info@we-ef.com - <https://we-ef.com>

Subject to technical changes and errors. - Generated on 23/10/2024

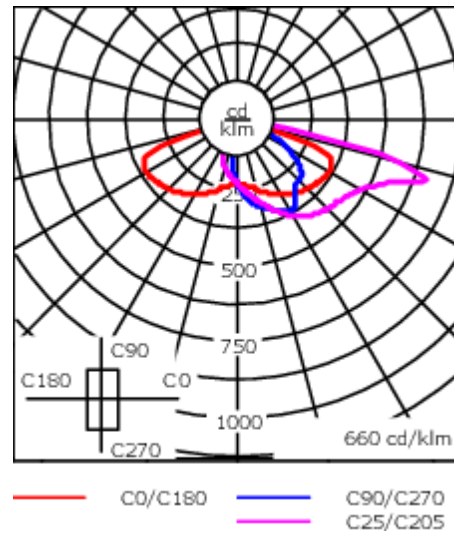
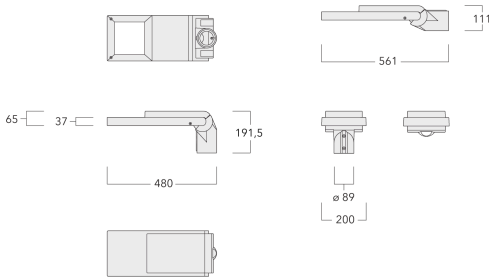
102-0428**AFL110 LED****we-ef**

Specifications

Material description

Body	Marine-grade, die-cast aluminium alloy
Lens	Non-reflective safety glass lens
Colours	<div style="display: flex; align-items: center;"> <div style="width: 20px; height: 15px; background-color: black; margin-right: 5px;"></div> RAL9004 Signal black </div> <div style="display: flex; align-items: center; margin-top: 5px;"> <div style="width: 20px; height: 15px; background-color: #cccccc; margin-right: 5px;"></div> RAL9006 White aluminium </div> <div style="display: flex; align-items: center; margin-top: 5px;"> <div style="width: 20px; height: 15px; background-color: #808080; margin-right: 5px;"></div> RAL9007 Grey aluminium </div> <div style="display: flex; align-items: center; margin-top: 5px;"> <div style="width: 20px; height: 15px; background-color: #333333; margin-right: 5px;"></div> RAL7016 Anthracite grey </div> <div style="display: flex; align-items: center; margin-top: 5px;"> <div style="width: 20px; height: 15px; background-color: #e0e0e0; margin-right: 5px;"></div> RAL9016 Traffic white </div>
Gasket	CCG® Controlled Compression Gasket
Fasteners	PCS Polymer Coated Stainless Steel Hardware
Ingress protection	IP66
Impact resistance	IK08
Corrosion resistance	5CE
Windage	0.092 m ²

Electrical description

Power supply	220-240V / 50-60 Hz
Driver / Ballast	Integral EC electronic converter. DALI
Power factor	> 0.9
Surge protection	6/6kV, optional 10kV

Additional information

Lifetime	Ta=25° L90B10 > 100000h
Energy efficiency class	C-D (Light source)

WE-EF LEUCHTEN GmbH

Töpinger Straße 16, 29646 Bispingen, Germany - Phone: +49 5194 909-0

info@we-ef.com - <https://we-ef.com>

Subject to technical changes and errors. - Generated on 23/10/2024

102-0428

AFL110 LED

we-ef

Control

Eco Step Dim® Advanced

Description	Part ID
Eco Step Dim® Advanced LED	430-0002

R2C Ready to Connect

Description	Part ID
R2C Ready to Connect (top)	430-0019
R2C Ready to Connect (below)	430-0027
R2C Ready to Connect (top and below)	430-0032

WE-EF LEUCHTEN GmbH

Töpinger Straße 16, 29646 Bispingen, Germany - Phone: +49 5194 909-0

info@we-ef.com - <https://we-ef.com>

Subject to technical changes and errors. - Generated on 23/10/2024

102-0428

AFL110 LED

we-ef

Mounting Accessories

Bird deterrent

Description	Part ID
Bird deterrent BD	430-0015

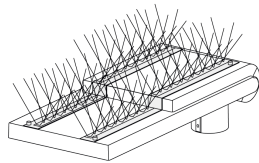

Adaptor

Description	Part ID
Adaptor AFL100	102-0392



Wall and pole brackets RE

WE-EF LEUCHTEN GmbH

Töpinger Straße 16, 29646 Bispingen, Germany - Phone: +49 5194 909-0

info@we-ef.com - <https://we-ef.com>

Subject to technical changes and errors. - Generated on 23/10/2024

AFL110 LED

Description	Part ID	C1	D1	D2	D × L1	H1	M1	Weight (kg)
RE2-540 Pole bracket, double	111-0043	200			76 x 130	550		5.30

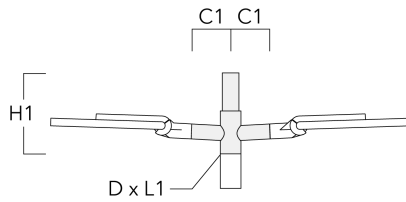

RE0-540 Wall bracket	111-0084	180	230	195		12	3.20	
----------------------	----------	-----	-----	-----	--	----	------	--

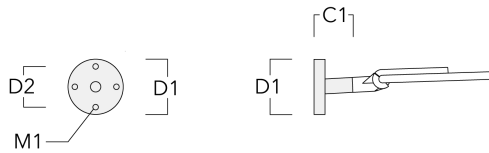

AFL110 LED

Description	Part ID	C1	D1	D2	D × L1	H1	M1	Weight (kg)
RE1-540 Pole bracket, single	111-0042	200			76 x 130	500		4.60



Pole brackets RF

Description	Part ID	C1	D × L1	H1	Weight (kg)
RF2-540 Pole bracket, double	111-0047	200	76 x 80	200	3.30



AFL110 LED

Description	Part ID	C1	D × L1	H1	Weight (kg)
RF1-540 Pole bracket, single	111-0046	200	76 x 80	200	2.60



Wall and pole brackets RX

Description	Part ID	C1	D1	D2	D × L1	H1	H2	M1	M2	Weight (kg)
RX1-540 Pole bracket, single	111-0054	1000			76 x 130	550				6.8

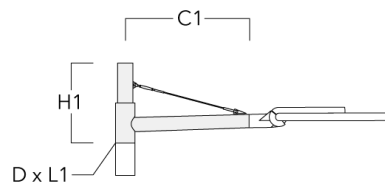

AFL110 LED

Description	Part ID	C1	D1	D2	D × L1	H1	H2	M1	M2	Weight (kg)
RX2-540 Pole bracket, double	111-0055	1000			76 x 130	550				9.70



RX0-540 Wall bracket	111-0086	1000	140	100		450	385	30	12	5.20
----------------------	----------	------	-----	-----	--	-----	-----	----	----	------



102-0428

AFL110 LED

we-ef

Optical Accessories

Backlight shield

Description	Part ID	Additional information
LS180	430-0029	Glare Shield for backlight spill. Glare Shield factory-installed or available as retrofit kit. Suitable for [S61][S66][R61][P66][Q66][A61] lenses. Must be specified at time of ordering.



102-0428

AFL110 LED

WE-EF LEUCHTEN GmbH

Töpinger Straße 16, 29646 Bispingen, Germany

Phone: +49 5194 909-0

info@we-ef.com

<https://we-ef.com>

Subject to technical changes and errors.

Generated on 23/10/2024