

102-0440

AFL110 LED

we-ef



Description

IP66, Class I or Class II. IK08. Marine-grade, die-cast aluminium alloy. 5CE superior corrosion protection including PCS hardware. CCG® Controlled Compression Gasket. Non-reflective flat safety glass cover, hinged. Integral EC electronic converter. CAD-optimised optics for superior illumination and glare control. OLC® One LED Concept. Factory installed LED circuit board. The luminaire is factory-sealed and does not need to be opened during installation. Can be used as post top or side entry version. Specification at time of order is recommended.

Spigot Ø 3" x 4"

Contact WE-EF direct or your local WE-EF sales representative for an individual solution designed to precisely meet your needs.

Weight	10.40 lb
Light distribution	[P66] Type II Medium
Light source	LED-8/8W / 350 mA - 3000K
CRI	80
Power supply	electronic gear
LEDs	8
Rated input power	9.5 W
Nominal Lumen (lm)	
LED Lumen	155
Total Lumen	1240
Tj	85
Rated lumens (lm)	
LED Lumen	131.7
Total Lumen	1053.9
Ta	25

WE-EF LIGHTING USA, LLC

410-D Keystone Drive, 15086 Warrendale, PA 15086 - Phone: +1 724 742 0030
customersupport.usa@we-ef.com - <https://we-ef.com/us>
Subject to technical changes and errors. - Generated on 11/23/2024

102-0440



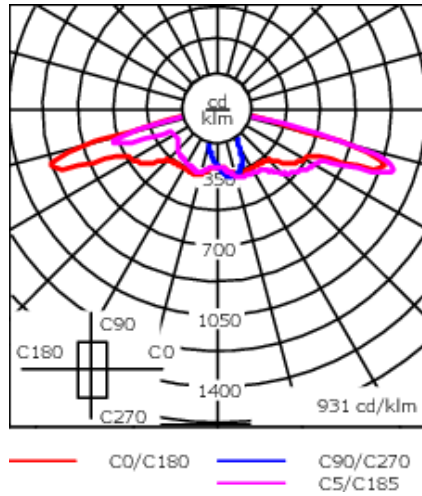
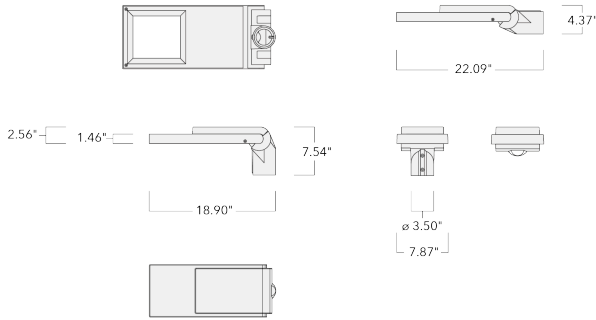

we-ef

AFL110 LED



Specifications

Material description

Body	Marine-grade, die-cast aluminium alloy
Lens	Non-reflective safety glass lens
Colors	<ul style="list-style-type: none">  RAL9004 Black  RAL9007 Grey Metallic  RAL9016 White  RAL8019 Dark Bronze
Gasket	CCG® Controlled Compression Gasket
Fasteners	PCS Polymer Coated Stainless Steel Hardware
Ingress protection	IP66
Impact resistance	IK08
Corrosion resistance	5CE
Windage	10.76 ft ²

Electrical description

Power supply	120V - 277V Universal Driver
Driver / Ballast	Integral EC electronic converter. 0-10V
Power factor	> 0.9
Surge protection	In-line bracket 10kV Surge Protector

Additional information

Lifetime	Ta=25°/40° L90B10 > 100000h
----------	-----------------------------

WE-EF LIGHTING USA, LLC

410-D Keystone Drive, 15086 Warrendale, PA 15086 - Phone: +1 724 742 0030

customersupport.usa@we-ef.com - <https://we-ef.com/us>

Subject to technical changes and errors. - Generated on 11/23/2024

102-0440

AFL110 LED

we-ef

Mounting Accessories

Bird deterrent

Description	Part ID
Bird deterrent BD	430-0015

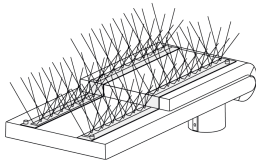

WE-EF LIGHTING USA, LLC

410-D Keystone Drive, 15086 Warrendale, PA 15086 - Phone: +1 724 742 0030
customersupport.usa@we-ef.com - <https://we-ef.com/us>

Subject to technical changes and errors. - Generated on 11/23/2024

Adaptor

Description	Part ID
Adaptor AFL100	102-0392

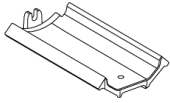

Wall and pole brackets RE

Description	Part ID	C1	D1	D2	D x L1	H1	M1	Weight (lb)
RE2-540 Pole bracket, double	111-0043	7.87			3 x 5	21.65		11.68

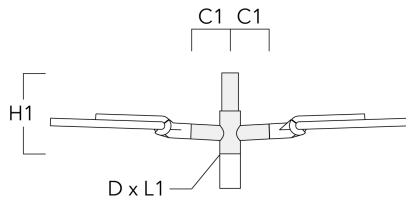

WE-EF LIGHTING USA, LLC

102-0440
AFL110 LED

Description	Part ID	C1	D1	D2	D × L1	H1	M1	Weight (lb)
RE0-540 Wall bracket	111-0084	7.09	9.06	7.68			0.47	7.05

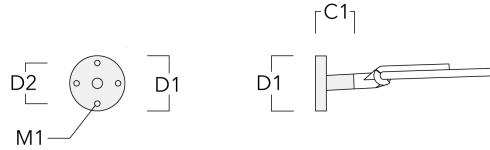

RE1-540 Pole bracket, single	111-0042	200			3 x 5	500		4.60
------------------------------	----------	-----	--	--	-------	-----	--	------

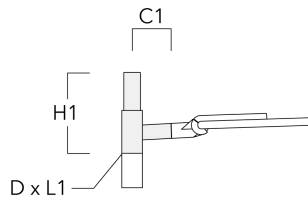

WE-EF LIGHTING USA, LLC

410-D Keystone Drive, 15086 Warrendale, PA 15086 - Phone: +1 724 742 0030
 customersupport.usa@we-ef.com - <https://we-ef.com/us>
 Subject to technical changes and errors. - Generated on 11/23/2024

Pole brackets RF

Description	Part ID	C1	D x L1	H1	Weight (lb)
RF2-540 Pole bracket, double	111-0047	7.87	3 x 3	7.87	7.28

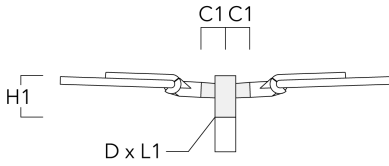

RF1-540 Pole bracket, single	111-0046	200	3 x 3	200	2.60
------------------------------	----------	-----	-------	-----	------

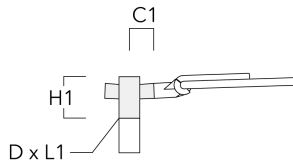

WE-EF LIGHTING USA, LLC

410-D Keystone Drive, 15086 Warrendale, PA 15086 - Phone: +1 724 742 0030
customersupport.usa@we-ef.com - <https://we-ef.com/us>

Subject to technical changes and errors. - Generated on 11/23/2024

Wall and pole brackets RX

Description	Part ID	C1	D1	D2	D x L1	H1	H2	M1	M2	Weight (lb)
RX1-540 Pole bracket, single	111-0054	39.37			2.99 x 3.15	21.65				14.99



RX2-540 Pole bracket, double	111-0055	39.37			2.99 x 3.15	21.65				21.38
------------------------------	----------	-------	--	--	-------------	-------	--	--	--	-------

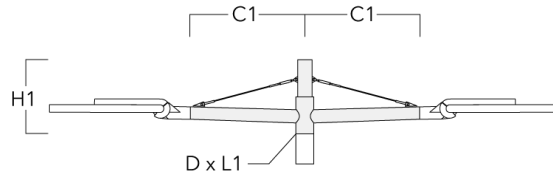

WE-EF LIGHTING USA, LLC

410-D Keystone Drive, 15086 Warrendale, PA 15086 - Phone: +1 724 742 0030

customersupport.usa@we-ef.com - <https://we-ef.com/us>

Subject to technical changes and errors. - Generated on 11/23/2024

102-0440
AFL110 LED

Description	Part ID	C1	D1	D2	D × L1	H1	H2	M1	M2	Weight (lb)
RX0-540 Wall bracket	111-0086	39.37	5.51	3.94		17.72	15.16	1.18	0.47	11.46

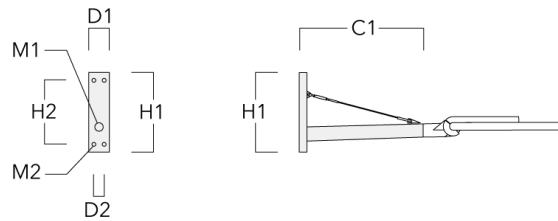

WE-EF LIGHTING USA, LLC

410-D Keystone Drive, 15086 Warrendale, PA 15086 - Phone: +1 724 742 0030
customersupport.usa@we-ef.com - <https://we-ef.com/us>
Subject to technical changes and errors. - Generated on 11/23/2024

102-0440

AFL110 LED

we-ef

Optical Accessories

Backlight shield

Description	Part ID	Additional information
LS180	430-0029	Glare Shield for backlight spill. Glare Shield factory-installed or available as retrofit kit. Suitable for [S61][S66][R61][P66][Q66][A61] lenses. Must be specified at time of ordering.

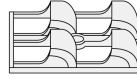

WE-EF LIGHTING USA, LLC

410-D Keystone Drive, 15086 Warrendale, PA 15086 - Phone: +1 724 742 0030
customersupport.usa@we-ef.com - <https://we-ef.com/us>

Subject to technical changes and errors. - Generated on 11/23/2024