

127-1232

ASP534 LED

**we-ef**



**Description**

IP55. Class I. IK10. Marine-grade, die-cast aluminum alloy. 5CE superior corrosion protection including PCS hardware. Silicone CCG® Controlled Compression Gasket. Polycarbonate main lens. CAD-optimized optics for superior illumination and glare control. Integral driver in thermally separated compartment. OLC® One LED Concept. Factory-installed LED circuit board.

Recommended mounting height 10-13 ft, depending on lamp type selected; brackets to be ordered separately.

Specify product with 7 Digit product code - Finish Color. Accessories, such as mounting, optical, and electrical, must be specified separately.

Example: XXX-XXXX-9004 (Black)  
+ XXX-XXXX (Accessory 1)

|                    |                              |
|--------------------|------------------------------|
| Weight             | 25.10 lb                     |
| Light distribution | [R65] Type IV Medium         |
| Light source       | LED-24/48W / 700 mA - 3000 K |
| CRI                | 80                           |
| Power supply       | electronic gear              |
| BUG                | B2 U1 G1                     |
| LEDs               | 24                           |
| Rated input power  | 54 W                         |

**Nominal Lumen (lm)**

|             |      |
|-------------|------|
| LED Lumen   | 290  |
| Total Lumen | 6960 |
| Tj          | 85   |

**Rated lumens (lm)**

|             |        |
|-------------|--------|
| LED Lumen   | 225    |
| Total Lumen | 5398.9 |
| Ta          | 25     |

**WE-EF LIGHTING USA, LLC**

410-D Keystone Drive, 15086 Warrendale, PA 15086 - Phone: +1 724 742 0030  
customersupport.usa@we-ef.com - <https://we-ef.com/us>  
Subject to technical changes and errors. - Generated on 11/23/2024

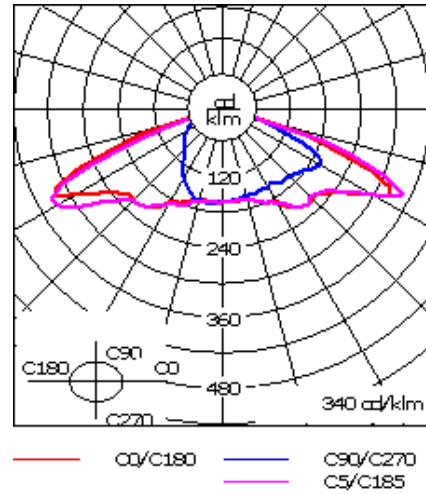
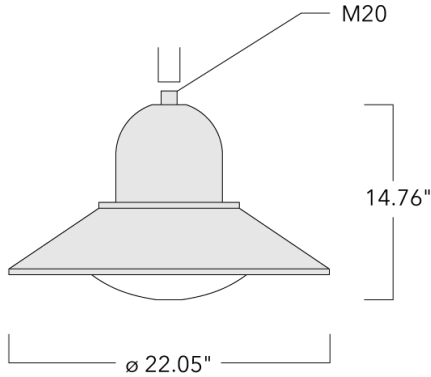

## Specifications

### Material description

|                      |   |
|----------------------|---|
| Body                 | Marine-grade die-cast aluminium alloy   |
| Lens                 | Polycarbonate main lens   |
| Colors               | <div style="display: flex; flex-direction: column; gap: 5px;"> <div style="display: flex; align-items: center;"> <div style="width: 20px; height: 10px; background-color: black; margin-right: 5px;"></div> <span>RAL9004 Black</span> </div> <div style="display: flex; align-items: center;"> <div style="width: 20px; height: 10px; background-color: grey; margin-right: 5px;"></div> <span>RAL9007 Grey Metallic</span> </div> <div style="display: flex; align-items: center;"> <div style="width: 20px; height: 10px; background-color: white; margin-right: 5px;"></div> <span>RAL9016 White</span> </div> <div style="display: flex; align-items: center;"> <div style="width: 20px; height: 10px; background-color: darkgrey; margin-right: 5px;"></div> <span>RAL8019 Dark Bronze</span> </div> </div> |
| Gasket               | Silicone rubber gasket  |
| Fasteners            | PCS Polymer Coated Stainless Steel hardware   |
| Ingress protection   | IP55  |
| Impact resistance    | IK10  |
| Corrosion resistance | 5CE   |
| Windage              | 0.967   |

### Electrical description

|                  |   |
|------------------|---|
| Power supply     | Integral [ECG] electronic driver 120V-277V. 0-10V dimmable, to be specified with order. |
| Driver / Ballast | Integral EC electronic converter  |
| Power factor     | > 0.9   |

#### WE-EF LIGHTING USA, LLC

410-D Keystone Drive, 15086 Warrendale, PA 15086 - Phone: +1 724 742 0030  
 customersupport.usa@we-ef.com - <https://we-ef.com/us>  
 Subject to technical changes and errors. - Generated on 11/23/2024

**127-1232**

**ASP534 LED**

**we-ef**

**Additional information**

---

|            |   |
|------------|---|
| Lifetime   | Ta=25°/40° L90B10 > 90000h  |
| BUG Rating | Please see individual Spec Sheets for classification of Backlight, Uplight and Glare. |
| Listings   | ETL listed. Suitable for wet locations.   |

---

**WE-EF LIGHTING USA, LLC**

410-D Keystone Drive, 15086 Warrendale, PA 15086 - Phone: +1 724 742 0030  
customersupport.usa@we-ef.com - <https://we-ef.com/us>  
Subject to technical changes and errors. - Generated on 11/23/2024

127-1232

**we-ef**

ASP534 LED

## Mounting Accessories

### Wall and pole brackets BA

| Description                  | Part ID  | C1    | D x L1 | H1    | H2  | L | M1   | Weight (lb) | C   | H    |
|------------------------------|----------|-------|--------|-------|-----|---|------|-------------|-----|------|
| BA0-420 Wall bracket, single | 300-0152 | 18.11 |        | 39.37 | 5.2 |   | 0.35 | 4.41        | 460 | 1000 |

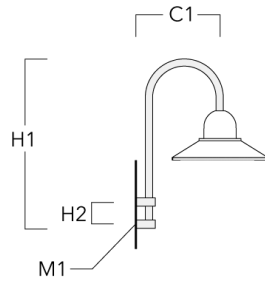

|                              |          |       |       |       |  |      |  |      |     |      |
|------------------------------|----------|-------|-------|-------|--|------|--|------|-----|------|
| BA1-420 Pole bracket, single | 300-0099 | 16.54 | 3 x 3 | 39.37 |  | 2.99 |  | 8.82 | 420 | 1000 |
|------------------------------|----------|-------|-------|-------|--|------|--|------|-----|------|

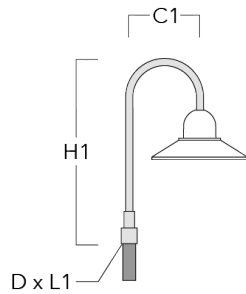

#### WE-EF LIGHTING USA, LLC

410-D Keystone Drive, 15086 Warrendale, PA 15086 - Phone: +1 724 742 0030

customersupport.usa@we-ef.com - <https://we-ef.com/us>

Subject to technical changes and errors. - Generated on 11/23/2024

**ASP534 LED**

| Description                  | Part ID  | C1    | D x L1 | H1    | H2 | L    | M1 | Weight (lb) | C   | H    |
|------------------------------|----------|-------|--------|-------|----|------|----|-------------|-----|------|
| BA2-420 Pole bracket, double | 300-0104 | 19.69 | 3 x 3  | 39.37 |    | 2.99 |    | 17.64       | 500 | 1000 |

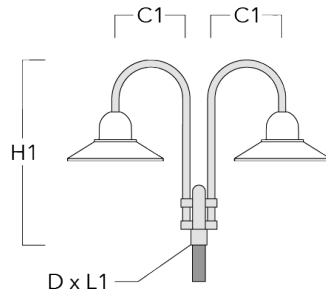

|                              |          |       |       |       |  |      |  |       |     |      |
|------------------------------|----------|-------|-------|-------|--|------|--|-------|-----|------|
| BA3-420 Pole bracket, triple | 300-0109 | 19.69 | 3 x 3 | 39.37 |  | 2.99 |  | 22.05 | 500 | 1000 |
|------------------------------|----------|-------|-------|-------|--|------|--|-------|-----|------|

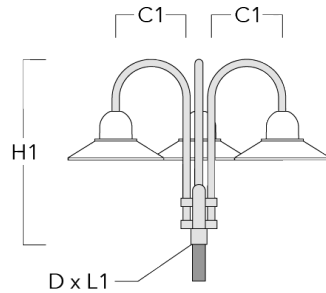

**WE-EF LIGHTING USA, LLC**

410-D Keystone Drive, 15086 Warrendale, PA 15086 - Phone: +1 724 742 0030

customersupport.usa@we-ef.com - <https://we-ef.com/us>

Subject to technical changes and errors. - Generated on 11/23/2024

**Wall and pole brackets BC**

| Description                  | Part ID  | C1  | H1   | H2    | M1 | Weight (lb) | C   | H    |
|------------------------------|----------|-----|------|-------|----|-------------|-----|------|
| BC0-420 Wall bracket, single | 300-0808 | 460 | 1230 | 11.81 | 8  | 2.30        | 460 | 1230 |

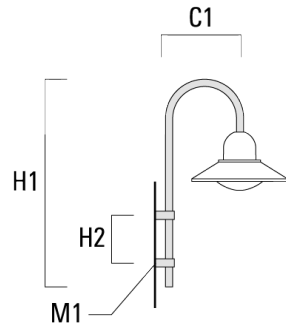

|                              |          |     |      |     |   |      |     |      |
|------------------------------|----------|-----|------|-----|---|------|-----|------|
| BC1-420 Pole bracket, single | 300-0768 | 500 | 1230 | 300 | 8 | 2.30 | 500 | 1230 |
|------------------------------|----------|-----|------|-----|---|------|-----|------|

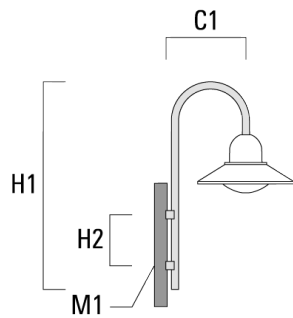

**ASP534 LED**

| Description                  | Part ID  | C1  | H1   | H2  | M1 | Weight (lb) | C   | H    |
|------------------------------|----------|-----|------|-----|----|-------------|-----|------|
| BC2-420 Pole bracket, double | 300-0767 | 500 | 1230 | 300 | 8  | 4.60        | 500 | 1230 |

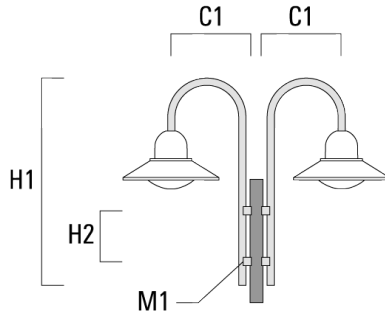

**Wall and pole brackets DA**

| Description                  | Part ID  | C1    | C2   | D × L1 | H1    | L | Weight (lb) | C   | H   |
|------------------------------|----------|-------|------|--------|-------|---|-------------|-----|-----|
| DA0-500 Wall bracket, single | 300-0146 | 20.08 | 2.76 |        | 25.59 |   | 12.57       | 510 | 650 |

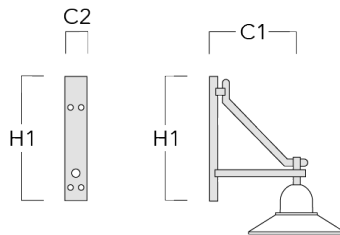

**WE-EF LIGHTING USA, LLC**

410-D Keystone Drive, 15086 Warrendale, PA 15086 - Phone: +1 724 742 0030  
 customersupport.usa@we-ef.com - <https://we-ef.com/us>

Subject to technical changes and errors. - Generated on 11/23/2024

127-1232

**we-ef**

ASP534 LED

| Description                  | Part ID  | C1    | C2 | D x L1 | H1    | L    | Weight (lb) | C   | H   |
|------------------------------|----------|-------|----|--------|-------|------|-------------|-----|-----|
| DA1-500 Pole bracket, single | 300-0138 | 20.08 |    | 3 x 3  | 27.56 | 2.99 | 12.57       | 510 | 700 |

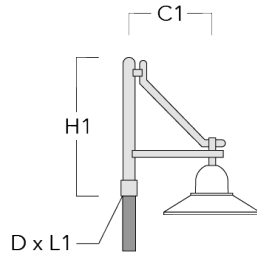

|                              |          |       |  |       |       |      |       |     |     |
|------------------------------|----------|-------|--|-------|-------|------|-------|-----|-----|
| DA2-500 Pole bracket, double | 300-0141 | 20.08 |  | 3 x 3 | 27.56 | 2.99 | 18.30 | 510 | 700 |
|------------------------------|----------|-------|--|-------|-------|------|-------|-----|-----|

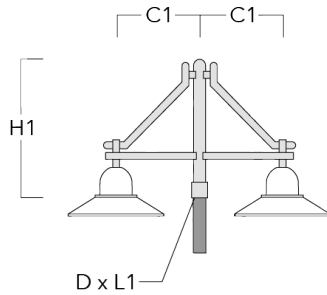

**WE-EF LIGHTING USA, LLC**

410-D Keystone Drive, 15086 Warrendale, PA 15086 - Phone: +1 724 742 0030  
customersupport.usa@we-ef.com - <https://we-ef.com/us>

Subject to technical changes and errors. - Generated on 11/23/2024



**ASP534 LED**

| Description                  | Part ID  | C1    | C2 | D x L1 | H1    | L    | Weight (lb) | C   | H   |
|------------------------------|----------|-------|----|--------|-------|------|-------------|-----|-----|
| DA3-500 Pole bracket, triple | 300-0144 | 20.08 |    | 3 x 3  | 27.56 | 2.99 | 24.03       | 510 | 700 |

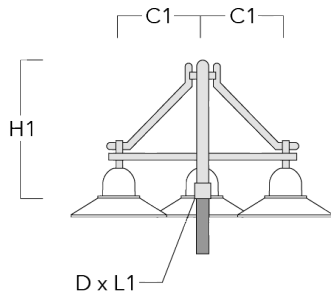

**Wall and pole brackets DB**

| Description                  | Part ID  | C1    | C2   | D x L1 | H1    | L | Weight (lb) | C   | H   |
|------------------------------|----------|-------|------|--------|-------|---|-------------|-----|-----|
| DB0-500 Wall bracket, single | 300-0169 | 20.08 | 2.76 |        | 25.59 |   | 12.13       | 510 | 650 |

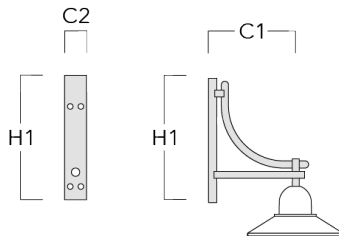

**WE-EF LIGHTING USA, LLC**

410-D Keystone Drive, 15086 Warrendale, PA 15086 - Phone: +1 724 742 0030

customersupport.usa@we-ef.com - <https://we-ef.com/us>

Subject to technical changes and errors. - Generated on 11/23/2024

127-1232

**we-ef**

ASP534 LED

| Description                  | Part ID  | C1    | C2 | D x L1 | H1    | L    | Weight (lb) | C   | H   |
|------------------------------|----------|-------|----|--------|-------|------|-------------|-----|-----|
| DB1-500 Pole bracket, single | 300-0190 | 20.08 |    | 3 x 3  | 27.56 | 2.99 | 12.13       | 510 | 700 |

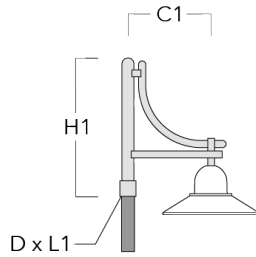

|                              |          |       |  |       |       |      |       |     |     |
|------------------------------|----------|-------|--|-------|-------|------|-------|-----|-----|
| DB2-500 Pole bracket, double | 300-0191 | 20.08 |  | 3 x 3 | 27.56 | 2.99 | 17.42 | 510 | 700 |
|------------------------------|----------|-------|--|-------|-------|------|-------|-----|-----|

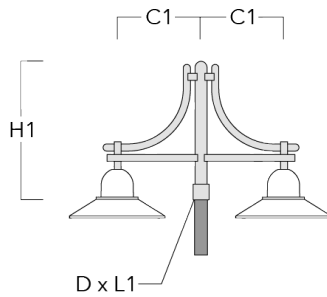

**WE-EF LIGHTING USA, LLC**

410-D Keystone Drive, 15086 Warrendale, PA 15086 - Phone: +1 724 742 0030  
customersupport.usa@we-ef.com - <https://we-ef.com/us>

Subject to technical changes and errors. - Generated on 11/23/2024

**ASP534 LED**

| Description                  | Part ID  | C1    | C2 | D × L1 | H1    | L    | Weight (lb) | C   | H   |
|------------------------------|----------|-------|----|--------|-------|------|-------------|-----|-----|
| DB3-500 Pole bracket, triple | 300-0192 | 20.08 |    | 3 x 3  | 27.56 | 2.99 | 22.71       | 510 | 700 |

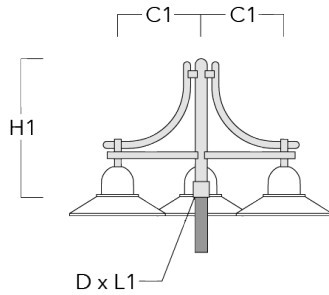

**Wall and pole brackets DS**

| Description                  | Part ID  | C1    | C2   | D × L1 | H1    | L | Weight (lb) | C   | H   |
|------------------------------|----------|-------|------|--------|-------|---|-------------|-----|-----|
| DS0-500 Wall bracket, single | 300-0064 | 20.08 | 2.76 |        | 25.59 |   | 5.51        | 510 | 650 |

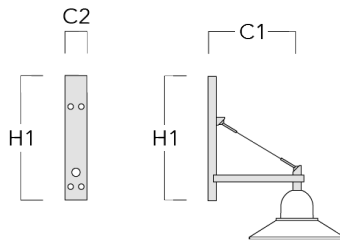

**WE-EF LIGHTING USA, LLC**

410-D Keystone Drive, 15086 Warrendale, PA 15086 - Phone: +1 724 742 0030  
 customersupport.usa@we-ef.com - <https://we-ef.com/us>

Subject to technical changes and errors. - Generated on 11/23/2024

127-1232

**we-ef**

ASP534 LED

| Description                  | Part ID  | C1    | C2 | D x L1 | H1    | L    | Weight (lb) | C   | H   |
|------------------------------|----------|-------|----|--------|-------|------|-------------|-----|-----|
| DS1-500 Pole bracket, single | 300-0063 | 20.08 |    | 3 x 3  | 28.54 | 2.99 | 8.60        | 510 | 725 |

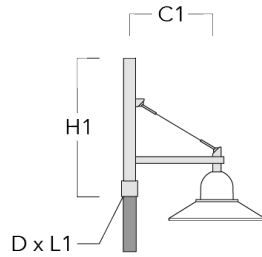

|                              |          |       |  |       |       |      |       |     |     |
|------------------------------|----------|-------|--|-------|-------|------|-------|-----|-----|
| DS2-500 Pole bracket, double | 300-0066 | 20.08 |  | 3 x 3 | 28.54 | 2.99 | 11.68 | 510 | 725 |
|------------------------------|----------|-------|--|-------|-------|------|-------|-----|-----|

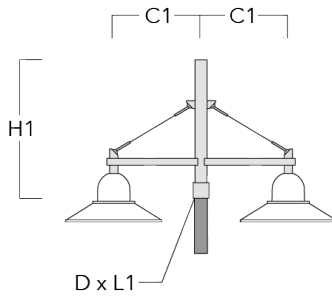

**WE-EF LIGHTING USA, LLC**

410-D Keystone Drive, 15086 Warrendale, PA 15086 - Phone: +1 724 742 0030  
customersupport.usa@we-ef.com - <https://we-ef.com/us>

Subject to technical changes and errors. - Generated on 11/23/2024

127-1232

**we-ef**

ASP534 LED

| Description                  | Part ID  | C1    | C2 | D x L1 | H1    | L    | Weight (lb) | C   | H   |
|------------------------------|----------|-------|----|--------|-------|------|-------------|-----|-----|
| DS3-500 Pole bracket, triple | 300-0069 | 20.08 |    | 3 x 3  | 28.54 | 2.99 | 14.77       | 510 | 725 |

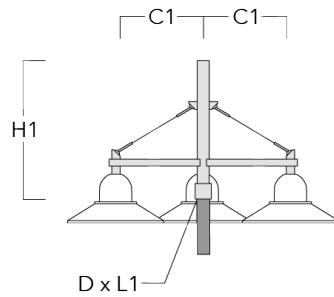

**WE-EF LIGHTING USA, LLC**

410-D Keystone Drive, 15086 Warrendale, PA 15086 - Phone: +1 724 742 0030  
customersupport.usa@we-ef.com - <https://we-ef.com/us>

Subject to technical changes and errors. - Generated on 11/23/2024

**127-1232**

**ASP534 LED**

**we-ef**

## **Optical Accessories**

### **Light shield**

| Description | Part ID  | Additional information   |
|-------------|----------|--|
| LS180       | 430-0029 | Glare Shield for backlight spill. Glare Shield factory-installed or available as retrofit kit. Suitable for [S60], [S65], [S70], [R65], [P65] lenses. Must be specified at time of ordering. |

**WE-EF LIGHTING USA, LLC**

410-D Keystone Drive, 15086 Warrendale, PA 15086 - Phone: +1 724 742 0030  
customersupport.usa@we-ef.com - <https://we-ef.com/us>

Subject to technical changes and errors. - Generated on 11/23/2024