

127-1261

AOP534 LED-FT

we-ef



Description

IP55. Class I. IK10. Marine-grade, die-cast aluminum alloy. 5CE superior corrosion protection including PCS hardware. Silicone CCG® Controlled Compression Gaskets. Polycarbonate main lens. CAD-optimized indirect optics for superior illumination and glare control.

Recommended mounting height 10-13 ft; brackets to be ordered separately.

Specify product with 7 Digit product code - Finish Color. Accessories, such as mounting, optical, and electrical, must be specified separately.

Example: XXX-XXXX-9004 (Black)

+ XXX-XXXX (Accessory 1)

| | |
|---------------------------|------------------------------|
| Weight | 17.00 lb |
| Light distribution | symmetric distribution [C60] |
| Light source | LED-FT-17W (4000K) |
| CRI | 80 |
| Power supply | electronic gear |
| BUG | B1 U2 G1 |
| LEDs | 1 |
| Rated input power | 20 W |
| Rated lumens (lm) | |
| LED Lumen | 2188 |
| Total Lumen | 2188 |
| Ta | 25 |
| Nominal Lumen (lm) | |
| LED Lumen | 3200 |
| Total Lumen | 3200 |
| Tc | 25 |

WE-EF LIGHTING USA, LLC

410-D Keystone Drive, 15086 Warrendale, PA 15086 - Phone: +1 724 742 0030

customersupport.usa@we-ef.com - <https://we-ef.com/us>

Subject to technical changes and errors. - Generated on 11/23/2024

127-1261

AOP534 LED-FT

we-ef

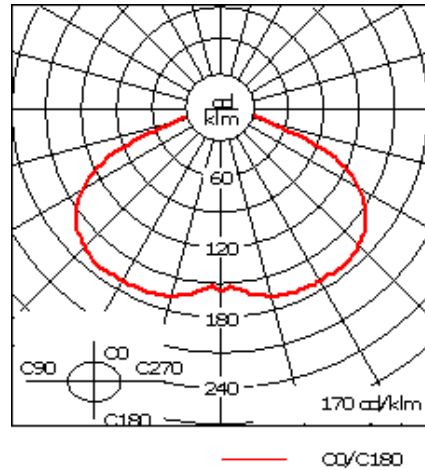
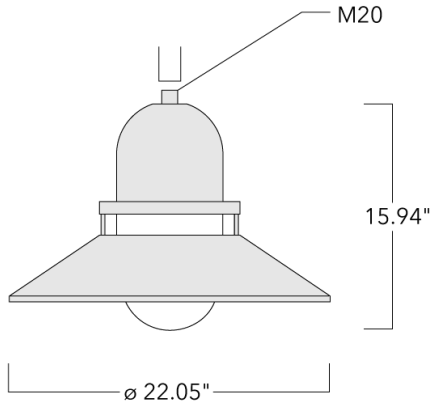

Specifications

Material description

| | |
|----------------------|---|
| Body | Marine-grade die-cast aluminium alloy |
| Lens | Polycarbonate outer lens |
| Colors | <ul style="list-style-type: none"> RAL9004 Black RAL9007 Grey Metallic RAL9016 White RAL8019 Dark Bronze |
| Gasket | Silicone rubber gasket |
| Fasteners | PCS Polymer Coated Stainless Steel hardware |
| Ingress protection | IP55 |
| Impact resistance | IK10 |
| Corrosion resistance | 5CE |
| Windage | 0.12 m ² |

WE-EF LIGHTING USA, LLC

410-D Keystone Drive, 15086 Warrendale, PA 15086 - Phone: +1 724 742 0030

customersupport.usa@we-ef.com - <https://we-ef.com/us>

Subject to technical changes and errors. - Generated on 11/23/2024

127-1261

we-ef

AOP534 LED-FT

Electrical description

| | |
|------------------|---|
| Power supply | Integral [ECG] electronic driver 120V-277V. 0-10V dimmable, to be specified with order. |
| Driver / Ballast | Integral EC electronic converter |
| Power factor | > 0.9 |
| Surge protection | Integral 10kV Surge Protector |

Additional information

| | |
|------------|---|
| Lifetime | Ta=25°/40° L70B50 > 50000h |
| BUG Rating | Please see individual Spec Sheets for classification of Backlight, Uplight and Glare. |
| Listings | ETL, UL-1598, CSA-C22.2#250.0. Suitable for Wet Locations. |

WE-EF LIGHTING USA, LLC

410-D Keystone Drive, 15086 Warrendale, PA 15086 - Phone: +1 724 742 0030
customersupport.usa@we-ef.com - <https://we-ef.com/us>
Subject to technical changes and errors. - Generated on 11/23/2024

Mounting Accessories

Wall and pole brackets BA

| Description | Part ID | C1 | D x L1 | H1 | H2 | L | M1 | Weight (lb) | C | H |
|------------------------------|----------|-------|--------|-------|-----|---|------|-------------|-----|------|
| BA0-420 Wall bracket, single | 300-0152 | 18.11 | | 39.37 | 5.2 | | 0.35 | 4.41 | 460 | 1000 |

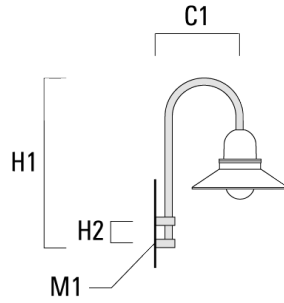

| | | | | | | | | | | |
|------------------------------|----------|-------|-------|-------|--|------|--|------|-----|------|
| BA1-420 Pole bracket, single | 300-0099 | 16.54 | 3 x 3 | 39.37 | | 2.99 | | 8.82 | 420 | 1000 |
|------------------------------|----------|-------|-------|-------|--|------|--|------|-----|------|

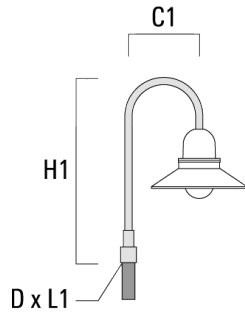

AOP534 LED-FT

| Description | Part ID | C1 | D x L1 | H1 | H2 | L | M1 | Weight (lb) | C | H |
|------------------------------|----------|-------|--------|-------|----|------|----|-------------|-----|------|
| BA2-420 Pole bracket, double | 300-0104 | 19.69 | 3 x 3 | 39.37 | | 2.99 | | 17.64 | 500 | 1000 |

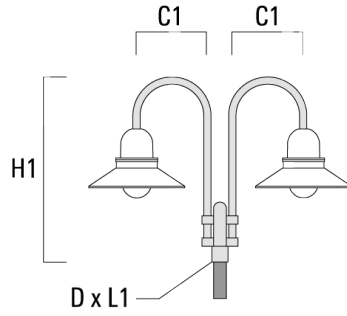

| | | | | | | | | | | |
|------------------------------|----------|-------|-------|-------|--|------|--|-------|-----|------|
| BA3-420 Pole bracket, triple | 300-0109 | 19.69 | 3 x 3 | 39.37 | | 2.99 | | 22.05 | 500 | 1000 |
|------------------------------|----------|-------|-------|-------|--|------|--|-------|-----|------|

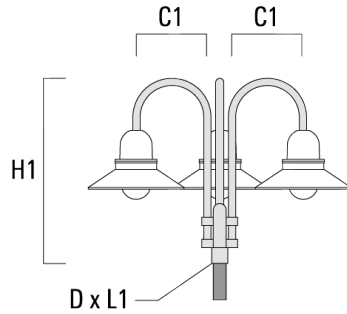

WE-EF LIGHTING USA, LLC

410-D Keystone Drive, 15086 Warrendale, PA 15086 - Phone: +1 724 742 0030
 customersupport.usa@we-ef.com - <https://we-ef.com/us>
 Subject to technical changes and errors. - Generated on 11/23/2024

Wall and pole brackets BC

| Description | Part ID | C1 | H1 | H2 | M1 | Weight (lb) | C | H |
|------------------------------|----------|-----|------|-------|----|-------------|-----|------|
| BC0-420 Wall bracket, single | 300-0808 | 460 | 1230 | 11.81 | 8 | 2.30 | 460 | 1230 |

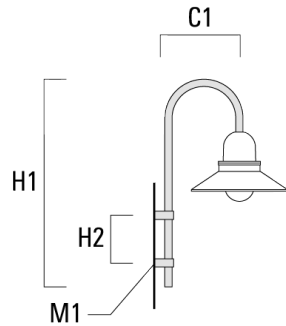

| | | | | | | | | |
|------------------------------|----------|-----|------|-----|---|------|-----|------|
| BC1-420 Pole bracket, single | 300-0768 | 500 | 1230 | 300 | 8 | 2.30 | 500 | 1230 |
|------------------------------|----------|-----|------|-----|---|------|-----|------|

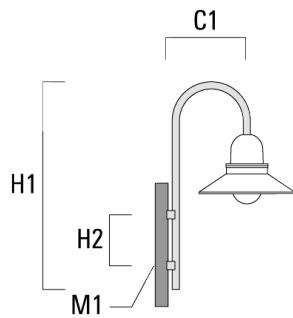

AOP534 LED-FT

| Description | Part ID | C1 | H1 | H2 | M1 | Weight (lb) | C | H |
|------------------------------|----------|-----|------|-----|----|-------------|-----|------|
| BC2-420 Pole bracket, double | 300-0767 | 500 | 1230 | 300 | 8 | 4.60 | 500 | 1230 |

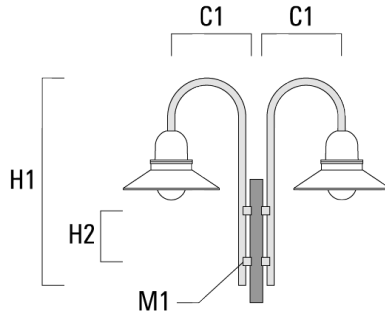

Wall and pole brackets DA

| Description | Part ID | C1 | C2 | D × L1 | H1 | L | Weight (lb) | C | H |
|------------------------------|----------|-------|------|--------|-------|---|-------------|-----|-----|
| DA0-500 Wall bracket, single | 300-0146 | 20.08 | 2.76 | | 25.59 | | 12.57 | 510 | 650 |

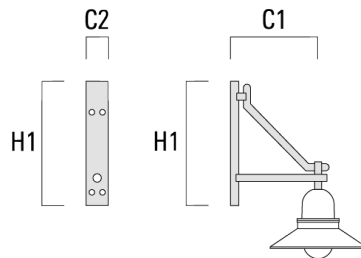

WE-EF LIGHTING USA, LLC

410-D Keystone Drive, 15086 Warrendale, PA 15086 - Phone: +1 724 742 0030

customersupport.usa@we-ef.com - <https://we-ef.com/us>

Subject to technical changes and errors. - Generated on 11/23/2024

AOP534 LED-FT

| Description | Part ID | C1 | C2 | D x L1 | H1 | L | Weight (lb) | C | H |
|------------------------------|----------|-------|----|--------|-------|------|-------------|-----|-----|
| DA1-500 Pole bracket, single | 300-0138 | 20.08 | | 3 x 3 | 27.56 | 2.99 | 12.57 | 510 | 700 |

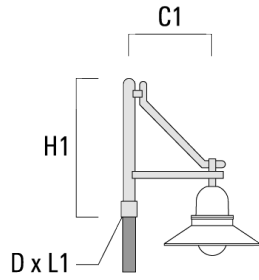

| | | | | | | | | | |
|------------------------------|----------|-------|--|-------|-------|------|-------|-----|-----|
| DA2-500 Pole bracket, double | 300-0141 | 20.08 | | 3 x 3 | 27.56 | 2.99 | 18.30 | 510 | 700 |
|------------------------------|----------|-------|--|-------|-------|------|-------|-----|-----|

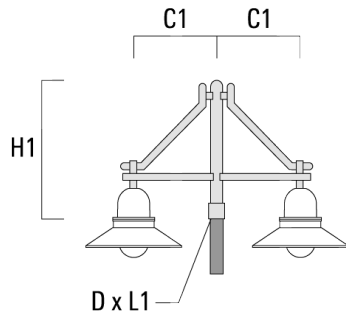

WE-EF LIGHTING USA, LLC

410-D Keystone Drive, 15086 Warrendale, PA 15086 - Phone: +1 724 742 0030
 customersupport.usa@we-ef.com - <https://we-ef.com/us>
 Subject to technical changes and errors. - Generated on 11/23/2024

AOP534 LED-FT

| Description | Part ID | C1 | C2 | D × L1 | H1 | L | Weight (lb) | C | H |
|------------------------------|----------|-------|----|--------|-------|------|-------------|-----|-----|
| DA3-500 Pole bracket, triple | 300-0144 | 20.08 | | 3 x 3 | 27.56 | 2.99 | 24.03 | 510 | 700 |

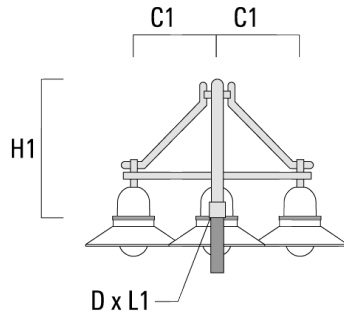

Wall and pole brackets DB

| Description | Part ID | C1 | C2 | D × L1 | H1 | L | Weight (lb) | C | H |
|------------------------------|----------|-------|------|--------|-------|---|-------------|-----|-----|
| DB0-500 Wall bracket, single | 300-0169 | 20.08 | 2.76 | | 25.59 | | 12.13 | 510 | 650 |

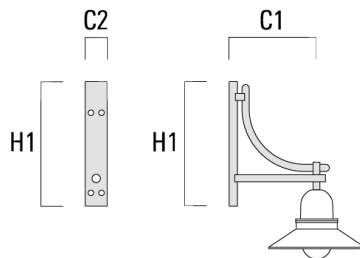

WE-EF LIGHTING USA, LLC

410-D Keystone Drive, 15086 Warrendale, PA 15086 - Phone: +1 724 742 0030

customersupport.usa@we-ef.com - <https://we-ef.com/us>

Subject to technical changes and errors. - Generated on 11/23/2024

127-1261

we-ef

AOP534 LED-FT

| Description | Part ID | C1 | C2 | D × L1 | H1 | L | Weight (lb) | C | H |
|------------------------------|----------|-------|----|--------|-------|------|-------------|-----|-----|
| DB1-500 Pole bracket, single | 300-0190 | 20.08 | | 3 x 3 | 27.56 | 2.99 | 12.13 | 510 | 700 |

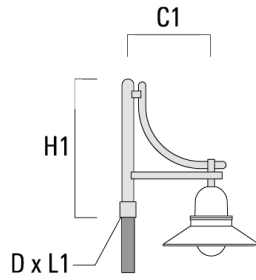

| | | | | | | | | | |
|------------------------------|----------|-------|--|-------|-------|------|-------|-----|-----|
| DB2-500 Pole bracket, double | 300-0191 | 20.08 | | 3 x 3 | 27.56 | 2.99 | 17.42 | 510 | 700 |
|------------------------------|----------|-------|--|-------|-------|------|-------|-----|-----|

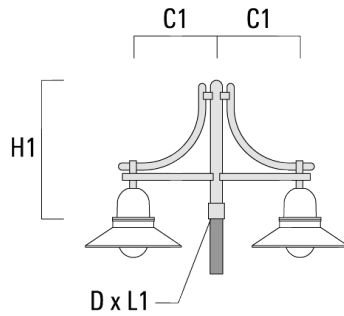

WE-EF LIGHTING USA, LLC

410-D Keystone Drive, 15086 Warrendale, PA 15086 - Phone: +1 724 742 0030
customersupport.usa@we-ef.com - <https://we-ef.com/us>

Subject to technical changes and errors. - Generated on 11/23/2024

AOP534 LED-FT

| Description | Part ID | C1 | C2 | D x L1 | H1 | L | Weight (lb) | C | H |
|------------------------------|----------|-------|----|--------|-------|------|-------------|-----|-----|
| DB3-500 Pole bracket, triple | 300-0192 | 20.08 | | 3 x 3 | 27.56 | 2.99 | 22.71 | 510 | 700 |

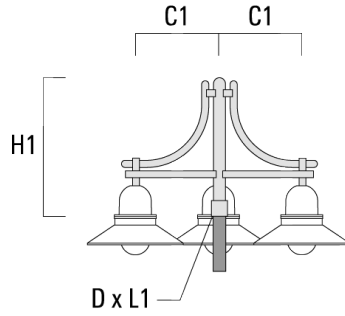

Wall and pole brackets DS

| Description | Part ID | C1 | C2 | D x L1 | H1 | L | Weight (lb) | C | H |
|------------------------------|----------|-------|------|--------|-------|---|-------------|-----|-----|
| DS0-500 Wall bracket, single | 300-0064 | 20.08 | 2.76 | | 25.59 | | 5.51 | 510 | 650 |

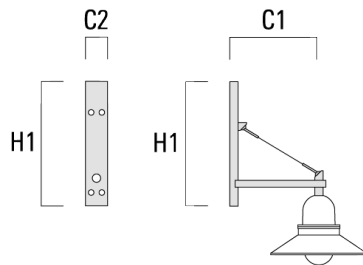

WE-EF LIGHTING USA, LLC

410-D Keystone Drive, 15086 Warrendale, PA 15086 - Phone: +1 724 742 0030
 customersupport.usa@we-ef.com - <https://we-ef.com/us>

Subject to technical changes and errors. - Generated on 11/23/2024

AOP534 LED-FT

| Description | Part ID | C1 | C2 | D x L1 | H1 | L | Weight (lb) | C | H |
|------------------------------|----------|-------|----|--------|-------|------|-------------|-----|-----|
| DS1-500 Pole bracket, single | 300-0063 | 20.08 | | 3 x 3 | 28.54 | 2.99 | 8.60 | 510 | 725 |

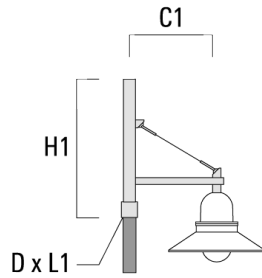

| | | | | | | | | | |
|------------------------------|----------|-------|--|-------|-------|------|-------|-----|-----|
| DS2-500 Pole bracket, double | 300-0066 | 20.08 | | 3 x 3 | 28.54 | 2.99 | 11.68 | 510 | 725 |
|------------------------------|----------|-------|--|-------|-------|------|-------|-----|-----|

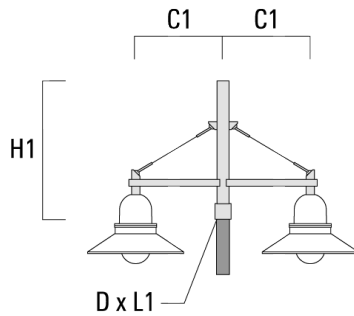

WE-EF LIGHTING USA, LLC

410-D Keystone Drive, 15086 Warrendale, PA 15086 - Phone: +1 724 742 0030
 customersupport.usa@we-ef.com - <https://we-ef.com/us>

Subject to technical changes and errors. - Generated on 11/23/2024

127-1261

we-ef

AOP534 LED-FT

| Description | Part ID | C1 | C2 | D x L1 | H1 | L | Weight (lb) | C | H |
|------------------------------|----------|-------|----|--------|-------|------|-------------|-----|-----|
| DS3-500 Pole bracket, triple | 300-0069 | 20.08 | | 3 x 3 | 28.54 | 2.99 | 14.77 | 510 | 725 |

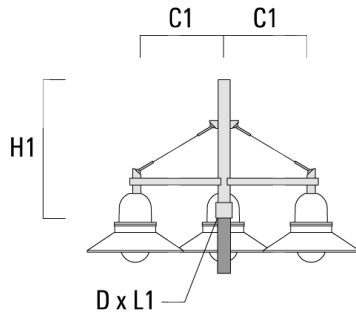

WE-EF LIGHTING USA, LLC

410-D Keystone Drive, 15086 Warrendale, PA 15086 - Phone: +1 724 742 0030
customersupport.usa@we-ef.com - <https://we-ef.com/us>

Subject to technical changes and errors. - Generated on 11/23/2024